



IBM Systems - iSeries

Networking

Get Started With iSeries Communications

Version 5 Release 4





IBM Systems - iSeries

Networking

Get Started With iSeries Communications

Version 5 Release 4

Note

Before using this information and the product it supports, be sure to read the information in "Notices," on page 91.

Sixth Edition (February 2006)

This edition applies to version 5, release 4, modification 0 of IBM i5/OS (product number 5722-SS1) and to all subsequent releases and modifications until otherwise indicated in new editions. This version does not run on all reduced instruction set computer (RISC) models nor does it run on CISC models.

© Copyright International Business Machines Corporation 1998, 2006. All rights reserved.

US Government Users Restricted Rights – Use, duplication or disclosure restricted by GSA ADP Schedule Contract with IBM Corp.

Contents

Get started with iSeries communications 1

What's new for V5R4	1
Printable PDF	2
Networking concepts	2
Advanced Peer-to-Peer Networking.	2
Advanced program-to-program communications	3
Dependent LU requester support	4
High-performance routing	4
Systems Network Architecture	5
TCP/IP	5
Configure your iSeries server for communications	6
Create a network interface description	6
Create a network server description	6
Create a line description	6
Optimize communications performance	7
Improve wide area network performance	7
Improve local area network performance	9
Improve data path performance	10
Communications applications	17
User-written APPC applications	18
Distributed data management (DDM)	18
Application programming interface (API) performance considerations	18
Communicate with host systems	20
Match iSeries system parameters for a host system	20
Configure dependent LU requester (DLUR).	31
Communicate with a remote iSeries server	32
Match iSeries system line description parameters for a remote iSeries system	32
Match iSeries system controller description parameters for a remote iSeries system	34
Match iSeries system device description parameters for a remote iSeries system	35
Connect one iSeries server to another iSeries server	36
Communicate with remote workstation controllers	40
Match iSeries system parameters for 5494 controllers	40
Match iSeries system parameters for 3x74 controller	48
Match iSeries system parameters for finance controllers	53
Match iSeries system parameters for retail controllers	58
Common networking standards	68
Local area network standards	68
Wide area network standards	70

Troubleshoot communications problems	72
Display message queues to solve communication problems	72
Display the Product Activity Log to solve communication problems	73
Display the Print Error Log to solve communication problems	73
Solve communication problems using communications trace	74
Solve communication problems using the system problem log	77
Solve communication problems using status information	77
Considerations for system tuning during error recovery	77
Use error messages to aid in error recovery.	78
Solve communication problems using reason codes	78
Reference Information	80
Example details: iSeries to host server connection over a nonswitched SDLC line	80
Example details: iSeries to host server connection over a token-ring line	81
Example details: iSeries server DLUR support with connection to the host server.	82
Example details: iSeries server with APPN connection to VTAM	82
Example details: iSeries server to iSeries server connection using X.25	83
Example details: iSeries server to iSeries server connection using SDLC	84
Example details: iSeries server to iSeries server connection using one-way automatic dialing	85
Example details: iSeries server to iSeries server connection using Enterprise Extender (HPRIP).	87
Example details: iSeries server connection to a 3174 control unit.	88
Example details: iSeries server connection to a finance network	88
Example details: iSeries server connection to 4690 LU0 over token-ring network	88
Example details: iSeries server connection to 4690 peer over token-ring network	89

Appendix. Notices 91

Trademarks	93
Terms and conditions	93

Get started with iSeries communications

The iSeries™ server can use many different networking technologies. Supported protocols include TCP/IP, APPC, APPN, HPR, Remote workstation, asynchronous, and binary synchronous communications.

iSeries communications configuration is done by either manually or automatically creating a set of configuration objects that represent the local and remote systems that are to communicate. The types of objects required for a communications configuration vary, depending on the type of communications being configured.

What's new for V5R4

Highlights the changes and improvements made to the Get started with iSeries communications topic.

Printable PDF

Print this topic to view a hardcopy of Get started with iSeries communications.

Networking concepts

Explanations and definitions of networking terms and concepts.

Configure iSeries for communications

Steps to take to configure your iSeries server for communications.

Optimize communications performance

Ways to achieve the best communications performance with your particular communications environment.

Communications applications

Information on implementing communications applications.

Communicate with host systems

Configure your iSeries system to communicate with host systems.

Communicate with a remote iSeries system

Configure your iSeries system to communicate with another iSeries system.

Communicate with remote workstation controllers

Configure your iSeries system to communicate with remote workstation controllers.

Networking standards

This topic introduces the types of common networking standards that are supported by the iSeries system.

Troubleshoot communication problems

Review this topic if you are having communications problems.

| **What's new for V5R4**

- | Enterprise Extender is a networking architecture that allows Systems Network Architecture (SNA) applications to run over Internet Protocol (IP) networks using High Performance Routing (HPR). This is the preferred way to run SNA applications over IP networks with communications input/output adapters (IOAs), such as Gigabit Ethernet, since these IOAs do not require an input/output processor (IOP).

l Communications adapters that do not use an IOP do not support SNA, therefore, Enterprise Extender is required to run SNA over these adapters. IBM® recommends that Enterprise Extender be used in place of AnyNet®.

l Communications trace is improved to capture HPR data running over IP networks, which allows you to troubleshoot Enterprise Extender communications problems.

Printable PDF

To view or download the PDF version, select Get started with iSeries communications (about 2180 KB).

Saving PDF files

To save a PDF file on your workstation for viewing or printing:

1. Right-click the PDF file in your browser (right-click the link above).
- l 2. Click the option that saves the PDF locally.
3. Navigate to the directory in which you want to save the PDF file.
4. Click **Save**.

Downloading Adobe Reader

l You need Adobe Reader installed on your system to view or print these PDFs. You can download a free copy from the Adobe Web site (<http://www.adobe.com/products/acrobat/readstep2.html>) .

Networking concepts

If you would like more information on networking topics, review the following:

- Advanced Peer-to-Peer Networking® (APPN) support
- Advanced Program-to-Program Communications (APPC)
- Dependent LU Requester Support (DLUR)
- High-performance routing (HPR)
- Systems Network Architecture (SNA)
- TCP/IP

Advanced Peer-to-Peer Networking

Advanced Peer-to-Peer Networking (APPN) is one type of data communications support that is provided by the iSeries system. This support routes data in a network between two or more advanced program-to-program systems. The systems do not need to be directly connected in the same network or adjacent networks.

The APPC/APPN support handles all of the SNA protocol requirements when your system is communicating with a remote system that uses the logical unit (LU) session type 6.2 and node type 2.1 architectures. The remote system can be any of the following systems:

- iSeries system
- System/36™
- System/38™
- IBM personal computer
- Displaywriter
- Series/1
- 5520 Administrative System
- RISC System/600 (Reduced Instruction Set Computer)
- DPPX/370 (Distribute Processing Programming Executive)
- One of the following host systems:
 - System/370™

- System/390®
- 30XX processor
- 43XX processor
- 9370 system
- Another system that supports the appropriate level of architecture

The iSeries APPN support is an enhancement to the SNA Node Type 2.1 architecture that supplies networking functions. These enhancements are easy-to-use, are dynamic; and give control of the network to the peer systems that make up the network. APPN provides you with the following advanced functions:

- Distributed directory services
- Dynamic route selection that is based on user-specified values
- Intermediate session routing
- Routing of data by using transmission priorities.

With the exception of intermediate session routing, HPR builds on and uses these APPN functions. For more information on HPR, see high-performance routing.

Advanced program-to-program communications

Advanced program-to-program communications (APPC) is data communications support that allows programs on an iSeries server to communicate with programs on other systems having compatible communications support. APPC on the iSeries system provides an application programming interface to the Systems Network Architecture (SNA) logical unit (LU) type 6.2 and node type 2.1 architectures.

The APPC support handles all of the SNA protocol requirements when your system is communicating with a remote system that uses the LU type 6.2 and node type 2.1 architectures. You can connect your system to any other system that supports the APPC program interface. APPC application programs can also communicate over lines using the Internet Protocol (IP) of Transmission Control Protocol/Internet Protocol (TCP/IP).

The iSeries APPC support handles the protocol needed for communicating between an application program that runs on your iSeries system, and an application that runs on a remote system. The protocol consists of a set of verbs that are common to the local and remote systems in a network. However, the way in which each system provides a program interface to the verbs may differ.

The iSeries system provides the following program interfaces:

- The intersystem communications function (ICF) file interface. In ICF, the LU 6.2 verbs are carried out by using data description specifications (DDS) keywords and system-supplied formats.
- The Common Programming Interface (CPI) Communications call interface. Using CPI Communication calls carries the LU 6.2 verbs.
- The CICS® file interface. In CICS/400® support, the LU 6.2 verbs are carried out by using EXEC CICS commands.
- The sockets application programming interface (API). For the sockets API, the LU 6.2 verbs are carried out by using the socket functions.

The APPC support also handles networking functions, and allows peer systems in a network to start and end sessions without a controlling host system.

The iSeries Advanced Peer-to-Peer Networking (APPN) support is an enhancement to the node type 2.1 architecture. APPN provides additional networking functions such as searching distributed directories, dynamically selecting routes, routing of intermediate sessions, creating and starting remote locations, and routing data by using transmission priorities.

Built on APPN, high-performance routing (HPR) is an enhancement to APPN that enables improved availability and persistence during network outages.

Dependent LU requester support

Dependent LU Requester Support (DLUR) allows dependent secondary logical units (LU 0, 1, 2, and 3) an entry point into the APPN network. DLUR support gives the appearance of having an adjacent connection to VTAM®, but allows traversing the APPN network through intermediate nodes.

DLUR supports the following controllers, displays, and printers:

- Host devices, including 3270 emulation (*EML), remote job entry (*RJE), and program-to-program communications (*PGM)
- SNA Passthrough upstream devices
- DHCF display devices
- NRF display and printer devices
- SNUF devices (DSNX)

The normal SSCP-PU and SSCP-LU flows for dependent LUs are encapsulated in a control point server (CP-SVR) pipe. This pipe consists of two LU 6.2 sessions:

- Send
- Receive

At the primary end of the pipe is a **Dependent LU Server (DLUS)**. At the secondary end of the pipe is a **Dependent LU Requester (DLUR)**. DLUS and DLUR support the activation and deactivation of dependent physical units (PUs) and logical units (LUs) in the APPN network. The pipe consists of a pair of LU 6.2 conversations where two APPC applications (DLUR and DLUS) exchange dependent SNA SSCP flows. The flows are encapsulated in a general data stream (GDS) variable and sent in LU 6.2 logical records. The pair of conversations that are used to transmit encapsulated SNA is called the CP-SVR Pipe.

To configure DLUR, see the article [Configure Dependent LU Requester](#).

High-performance routing

High-Performance Routing (HPR) is the evolution of Advanced Peer-to-Peer Networking (APPN). HPR enhances APPN data routing performance and reliability, especially when using higher-speed lower-error links.

To support high-speed communications facilities, certain changes to the APPN architecture are required. These are necessary to allow switching in intermediate nodes to be done at a lower layer and to enable faster switching than in base APPN support. HPR changes the existing APPN intermediate session routing by using automatic network routing (ANR), which maximizes the storage and processing requirement in intermediate nodes. Each outbound packet has a predetermined path through the network so that intermediate routing nodes need not remember anything about HPR sessions that flow through them. Intermediate routing nodes in HPR simply route data that is based on information that is contained within the packet itself.

| Enterprise Extender (SNA over IP networks using HPR)

| Enterprise Extender is a networking architecture that allows Systems Network Architecture (SNA) applications to run over Internet Protocol (IP) networks using High Performance Routing (HPR). This is the preferred way to run SNA applications over IP networks with communications input/output adapters (IOAs), such as Gigabit Ethernet, since these IOAs do not require an input/output processor (IOP) and, therefore, do not natively support SNA. IBM recommends that Enterprise Extender be used in place of AnyNet.

| Enterprise Extender utilizes the following HPR option sets: 1401, 1402, 2006, and 2009. These option sets, as well as 1400, are described below.

The HPR function can operate under a base architecture, or can operate under the base architecture plus options. There are performance capabilities available under the *Tower RTP* (Rapid Transport Protocol) option not available with the base. See the following for a more thorough explanation of what architecture option is appropriate for you.

- **HPR-base option** (option set 1400): Its primary function is to provide automatic network routing (ANR). Products that only use this function can participate as intermediate nodes in one or more Rapid Transport Protocol (RTP) connections. This type of implementation cannot be an endpoint of an RTP connection. An addition to the base option is HPR link-level error recovery. A system that supports high-speed links does not always require link-level error recovery. It is optional because when link-level error recovery is eliminated, faster communications might occur when using high-quality data transmission.
- **RTP Tower option** (option set 1401): Implementations that support this option can act as an endpoint and are able to transport logical-unit to logical-unit session (LU-LU-session) session traffic across HPR networks by using Rapid Transport Protocol (RTP) connections. An RTP connection can only be made between two systems that support RTP. That is, there can only be a mix of systems in a given RTP connection's path through the network (systems that only support the HPR base option and systems that support the HPR tower option). However, there is the stipulation that *at least* the two end points in the path support the HPR tower option. Otherwise, APPN is used.

Note: An implementation that has the RTP Tower option also supports the base option. These systems can run as intermediate systems in the path.

- **Control Flows over RTP Tower option** (option set 1402): This option causes control-point to control-point sessions (CP-CP sessions) and route setup messages to flow over special RTP connections. CP-CP sessions are established between adjacent node pairs and are used to broadcast topology flows to the entire network so that every node has the topology for the entire network stored in its topology database. *Route setup messages* are request and reply messages that are used to obtain information about a route over which an RTP connection will be established. The route setup request is sent by the origin node to the destination node over the exact route that is to be used. It stops at each intermediate node along the way to gather information associated with the forward path. The route setup reply is returned by the destination node after receiving the route setup request. The reply follows the same path as the request (in the reverse direction) and stops at each intermediate node along the way to gather information about the reverse path. When the origin node receives the reply it uses the information to establish a new RTP connection or reroute an existing one.
- **Logical Data Link Control (LDLC) Support option** (option set 2006): LDLC is a Logical Link Control (LLC) type defined to be used with HPR networks in conjunction with the Control Flows over RTP Tower option (option set 1402) over reliable links that do not require link-level error recovery. LDLC is only used for Enterprise Extender links.
- **Native IP Data Link Control (DLC) option** (option set 2009): Native IP is a DLC option used with option sets 1400, 1401, 1402, and 2006 to allow you to take advantage of APPN/HPR functions such as class of service (COS) and adaptive rate based flow/congestion control in the IP environment. This option set contains the support for Enterprise Extender links.

Systems Network Architecture

In IBM networks, Systems Network Architecture (SNA) is the layered logical structure, formats, protocols, and operational sequences that are used for transmitting information units through networks. SNA also controls the configuration and operation of networks.

APPC, APPN, and HPR are some examples of the protocols included within SNA. They can be used to connect the iSeries server with other IBM systems, or non-IBM systems, to connect remote controllers, and to maintain a high level of security on your system.

TCP/IP

Transmission Control Protocol/Internet Protocol (TCP/IP) is a set of network protocols that enables computers to share resources and exchange information across a network. TCP/IP allows hosts to

communicate with each other regardless of the host or user's physical location, the operating system, or the network medium. TCP/IP operates in many different network environments, that include the Internet and corporate Intranets.

For more information, see the topic TCP/IP configuration fastpath.

Configure your iSeries server for communications

Follow these steps to configure your iSeries server for communications:

1. Depending on the type of hardware you have, you may need to refer to the following topics:
 - "Create a network interface description"
 - "Create a network server description"
2. "Create a line description." Depending on your hardware, the lines may be attached to a network server or a network interface.

Create a network interface description

The configuration settings for a Frame Relay network are contained in a network interface description.

To create a network interface description, do the following:

1. Type CRTNWIFR (Create Network Interface, Frame Relay Network) and press F4.
2. Use the online help information to choose the correct parameter values.
3. Press Enter. The network interface description is created.

Create a network server description

The Create Network Server Description (CRTNWSD) command creates a description for a network server. The network server description includes server software parameters, network protocol descriptions, and definitions of attached communications equipment (such as line descriptions).

To create a network server description, do the following:

1. Type the Create Network Server Description (CRTNWSD) command on the iSeries system command line and press F4.
2. Use the online help information to choose the correct parameter settings.
3. Press Enter. The network server description is created.

Create a line description

Line descriptions describe the physical line connection and the data link protocol to be used between the iSeries server and the network.

To create line descriptions, do the following:

1. Type the appropriate command from the following list on the iSeries system command line and press F4. The command you should type depends on the type of line you are creating.
 - Create Line Description (Ethernet) (CRTLINETH)
 - Create Line Description (Distributed Data Interface (DDI)) (CRTLINDDI)
 - Create Line Description (Frame Relay) (CRTLINFR)
 - Create Line Description (Synchronous Data Link Control (SDLC)) (CRTLINS DLC)
 - Create Line Description (Token-ring) (CRTLINTRN)
 - Create Line Description (Wireless) (CRTLINWLS)
 - Create Line Description (X.25) (CRTLINX25)
 - Create Line Description (Asynchronous Communications) (CRTLINASC)
 - Create Line Description (Binary Synchronous Communications) (CRTLINBSC)
 - Create Line Description (Facsimile Communications) (CRTLINFAX)
 - Create Line Description (Network Communications) (CRTLINNET)
 - Create Line Description (Point to Point Protocol Communications) (CRTLINPPP)
 - Create Line Description (Twinax Data Link Control Communications) (CRTLINTDLC)

2. Use the online help information to choose the correct parameter values.
3. Press Enter. The line description is created.

Optimize communications performance

Many factors can affect the performance of iSeries application programs. To achieve the best performance with your particular communications environment, you might want to review these topics:

- Improve wide area network (WAN) performance.
- Improve local area network (LAN) performance.
- Improve data path performance.

Improve wide area network performance

To achieve better performance with your iSeries server when communicating in a wide area network (WAN), you need to consider the following:

- “Adjust WAN protocols for optimum iSeries server performance”
- “Adjust the WAN line speed for optimum iSeries server performance”
- “WAN configuration considerations for IOPs” on page 8

Adjust WAN protocols for optimum iSeries server performance

Wide area network (WAN) protocols affect the communications performance on the iSeries server. Let us use X.25 for our example. For each X.25 communications controller, the iSeries server has some processing limitations for the line, the line speed, and the total number of virtual circuits that can be used. Performance degradation can be reduced by observing these limitations.

To optimize the iSeries system performance for wide area networks, perform these tasks:

- Reduce the total number of frames by using larger frames.
- To take advantage of these large frame sizes, change the MAXFRAME parameter on the line description (LIND) to reflect the maximum value. For X.25, increase the DFTPFSIZE and MAXFRAME parameters to their maximum value.
- Configure a WAN line as full-duplex to provide you with a higher throughput for applications that can take advantage of this mode. This can also provide higher throughput for multiple users.
- Increase frame relay to capacity.

The data rate for a given protocol might increase as frame size increases. Under these circumstances, the central processing unit (CPU) and the input/output processor (IOP) do not do as much processing. Fewer and larger frames also make more efficient use of the communications line (higher effective data rate) because of fewer overhead bytes and line turn-arounds.

Frame relay has equivalent performance over RS449, X.21, and V.35 assuming equal line speeds and conditions. Frame relay performance (CPU time) is similar to or slightly better than Synchronous Data Link Control. For properly tuned large transfer applications, the CPU and IOP have no problem using the line speed to capacity.

For information about configuring iSeries system communications, see the Communications

Configuration  book.

Adjust the WAN line speed for optimum iSeries server performance



In many cases, the communications line is the largest contributor to overall response time in the wide area network (WAN). Therefore, you should closely plan and manage its performance. In general, having the appropriate line speed is the key consideration for gaining the best performance.

To adjust the line speed for your wide area network, perform these tasks:

- Check the difference in performance between half-duplex utilization and full-duplex utilization on the line description.

- For interactive environments, keep line use below 30% to maintain predictable and consistent response times. Exceeding 50% line use typically slows down response time. The line use can be measured with the iSeries system performance tools.
- For large transfer environments, or for environments in which only a small number of users are sharing a line, increase line use to allow for acceptable response times.
- The CPU usage for fractional T1 support and other high-speed WAN connections is similar to any other line that runs the same type of work. As the speed of a line increases from a traditional low speed to a high-speed or full T1/E1/J1 speed, performance characteristics might change as follows:
 - With interactive transactions, performance might be slightly faster.
 - With a large transfer, performance might be significantly faster.
 - With a single job, performance might be too serialized to use the entire bandwidth.
 - With high throughput, performance is more sensitive to frame size.
 - With high throughput, performance is more sensitive to application efficiency.
 - With synchronous data link control (SDLC), the communications controller CPU usage increases because of polling.

Additional considerations for adjusting the wide area network line speed are the following:

- A common misconception about the line speed of each attached communications line is that the central processing unit (CPU) resource is used in a uniform fashion. Exact statements cannot be made about the number of lines that any given iSeries server model can support.
- Most communications applications use a lot of CPU resource (to process data, to support disk input and output) and communications line resource (to send and receive data or display I/O). The amount of line resource that is used is proportional to the total number of bytes that are sent or received on the line. Some additional CPU resource is used to process the communications software to support the individual sends (puts or writes) and receives (gets or reads). Communications input/output processor resource is also used to support the line activity.
- When a single job is running disk operations or doing non-overlapped CPU processing, the communications link is idle. If several sessions transfer concurrently, then the jobs are more interleaved and make better use of the communications link.
- Polling is an important consideration for synchronous data link control (SDLC) environments. All SDLC polling is handled by the communications controller and is governed by parameters in both the line and controller descriptions.
- For information about iSeries system configuration, see the Communications Configuration  book.
- For more information about performance tools, see the Performance Tools for iSeries  book.



WAN configuration considerations for IOPs

When configuring a communications controller, you should consider both subsystem storage and aggregate line speed. Subsystem storage is the amount of storage available on the communications controller. Aggregate line speed is the sum of individual lines speeds that are attached to the communications controller.

The following information can help you understand network configuration considerations for input/output processors (IOPs).

- For interactive environments, you should not exceed 60% use on the communications IOP. Exceeding this threshold in a large transfer environment or with a small number of concurrent users might still offer acceptable performance. Use the iSeries system performance tools to get the utilization.
- You can attach multiple IOPs to an iSeries system. The maximum number of IOPs that can be attached is determined by the iSeries server model. It is important to distribute the work load across several IOPs if the performance capabilities of a single IOP are exceeded.
- Even though an IOP can support certain configurations, a given iSeries server model might not have enough system resource (for example, CPU processing capacity) to support the work load over the lines.
- The use of larger frames generally improves large transfer performance in terms of capacity for the communications IOP and in terms of system response time. The amount of time that the IOP spends

processing a larger frame is only slightly more than the amount needed to process a smaller frame. If you use larger frames to transfer a single system message or block of data, the total number of frames required to complete the transfer are decreased.

- The values for IOP use in synchronous data link control (SDLC) environments do not necessarily increase consistently with the number of workstations or with the workload. An IOP can spend more time polling when the application is not using the line. It is possible to see a relatively high IOP use at low throughput levels.
- For information on iSeries server configuration, see the Communications Configuration  book.
- For more information on performance tools, see the Performance Tools for iSeries  book.

Improve local area network performance

To achieve better performance with your iSeries server when communicating in a local area network (LAN), you need to consider the following.

- “Adjust LANs for optimum communications performance”
- “Adjust LAN lines for optimum communications performance”
- “LAN line speed considerations for IOPs” on page 10

Adjust LANs for optimum communications performance

Local area networks (LAN) affect the communications performance on the iSeries server. Improvements to LAN input/output (IOPs) in the areas of increased central processing unit (CPU) time, IOP capacity, and support of IOP assist make them more efficient. This efficiency allows advanced program-to-program communications (APPC) to send request units to the IOP, passing the cost of processing frames to the IOP.

The following information can help you understand the protocol considerations for local area networks.

- A Data Link Control (DLC) can achieve a significantly higher data rate than other supported line types. This is due to the desirable combination of having a high media speed along with large frame sizes.
- When several sessions use a line or LAN concurrently, the aggregate data rate might be higher than when only one session is used.
- To achieve good performance in a multi-user interactive LAN environment, you should manage the number of active users so that LAN media use does not exceed 50%. (A 25% utilization is recommended for Ethernet environments because of media collisions that causes the program to loop). Operating at higher utilization might decrease response time because of excess queuing time for the line. In a large transfer environment in which a small number of users contend for the line, a higher line use might still offer acceptable performance.

For more information about iSeries server configuration, see the Communications Configuration  book.

Adjust LAN lines for optimum communications performance

Several parameters that you can change in the line description (LIND) and the controller description (CTLN) play an important role in system performance.

The following information can help you to understand the line considerations for local area networks.

- MAXFRAME on the line description (LIND) and the controller description (CTLN): Maximizing the frame size in a LAN environment supplies the best performance for large transfers. A large frame size does not negatively affect performance for small transfers. Configure both the iSeries system and the other link station for large frames. Otherwise, of the two maximum frame size values, the smaller is used when you transfer data. Bridges might also limit the maximum frame size. You should change the default value from 1994 to a larger size.
- LANMAXOUT on the CTLN (for advanced program-to-program communications (APPC) environments): This parameter governs how often the sending system waits for an acknowledgment.

The LANACKFRQ parameter value on one system should never have a greater value than the LANMAXOUT parameter value on the other system. The parameter values of the sending system should match the values on the receiving system.

- Setting appropriate values for the LANMAXOUT parameter along with the LAN acknowledgment frequency (LANACKFRQ) parameter for both the sending stations and receiving stations is essential for optimal performance. Other values might decrease throughput by 50% or even more if conditions trigger time-outs.
- LANWDWSTP for advanced program-to-program communications (APPC) on the controller description (CTLDD): If there are network congestion or overruns to certain target system adapters, then increasing the value from the default of *NONE to 2 or more might improve performance.

In general, setting the LANMAXOUT parameter value to *CALC or 2 offers the best performance for interactive environments and adequate performance for larger transfer environments.

- For large transfer environments, changing the LANMAXOUT value might significantly increase performance. As starting points, use the following guidelines:
 - When you are communicating with a recent model personal computer, increase the LANMAXOUT parameter, but keep the LANACKFRQ parameter set to *CALC. For older models of personal computers, use *CALC for both values to limit buffer overruns.
 - If LANACKFRQ and LANMAXOUT parameter values are changed without noticeable performance improvements, change the values back to *CALC.

For more information on iSeries server communications, see the Communications Configuration  book.



LAN line speed considerations for IOPs

When configuring an iSeries server with communications lines and local area networks (LANs), you should not overload an input/output processor (IOP) to prevent possible system performance bottlenecks.

The following tips and information can help you to understand the line speed considerations for IOPs.

- For the best performance use a 2843 IOP with one of the following IOAs:
 - Token Ring: 2744 100/16/4 Mbps Token Ring card
 - 10/100 Ethernet: 2838 IOA card
 - Gigabit Ethernet: 2743 or 5700 IOA for fiber optic connections or the 2760 or the 5701 IOA for UTP connections to the network
- Check that you do not have the LAN IOA running under an IOP that is also running a DASD IOA. The DASD IOA causes slower performance on the LAN IOA and you cannot reset the LAN adapter if there is a problem with it.
- When analyzing communications performance on a LAN line, you should be aware that resources other than the IOP use can become the bottleneck.
- You should have the highest capacity IOP available for file serving. You should have the highest capacity IOP available for environments that use many communications input and output operations for each transaction. The highest capacity IOP also minimizes the overall response time.

See the following references for more detail:

- For more information about iSeries server communications, see the Communications Configuration  book.
- For more information on IOP performance, see the Performance Tools for iSeries book. 

Improve data path performance

To assess the performance of your data path, you might want to review the following topics:

- Considerations for subsystem configuration for error recovery performance

- Communications performance considerations for interactive jobs
- Consider communications performance for batch jobs
- Mix interactive and batch jobs on a wide area network line
- Performance considerations for AnyNet communications
- Enterprise Extender communications for the iSeries system
- Migration from AnyNet to Enterprise Extender
- Subsystems

Considerations for subsystem configuration for error recovery performance

Each piece of work that runs on the iSeries system is called a job. Each job is a single, identifiable sequence of processing actions that represents a single use of the system. The basic types of jobs performed are interactive jobs, batch jobs, spooling jobs, autostart jobs, and prestart jobs.

Jobs that run in subsystems do all work that is performed on the iSeries server. As the number of users on the system increases, it becomes important for you to consider how the communications and interactive subsystems should be configured.

The configuration of subsystems has little impact in normal data path operations. However, multiple subsystems can provide multiple processes to do cleanup and recovery when error conditions occur. This can result in improved performance.

As the number of users on the system increases, you must consider the importance of how subsystems are configured:

- Consider limiting the number of devices that are serviced by a single subsystem. Between 200 and 300 devices for each subsystem are recommended. Use the following recommendations to divide these users:
 - The number of users in any given subsystem
 - The connectivity used to access the system
 - The type of work the users do
 - The geographic location of the users
- Create additional communications and interactive subsystems to split the work into multiple subsystems.
- The work that is performed in the QCMN subsystem is for connecting and disconnecting from the system. Error recovery considerations are important in the configuration of the communications subsystem.
- To prevent a subsystem from allocating a device, ensure that there are no workstation or type entries for the devices that you do not want to be allocated.
- Only use the AT(*ENTER) option if you must allow jobs to transfer into that subsystem.
- For each subsystem you have defined, you need to identify which users will run in which subsystems. Use the Add Work Station Entry (ADDWSE) command and the Remove Work Station Entry (RMVWSE) command. You can set up workstation entries that identify which devices that subsystem should allocate, as well as which devices a subsystem should not allocate.

Note: You can use the ADDWSE commands while the subsystem is active. However, subsystems do not reallocate device locks dynamically. Eventually, it might be necessary to end and restart the subsystems to have the device locks allocated to the chosen subsystem.

To specify the devices a communications subsystem **should** allocate:

```
ADDCMNE SBSD(libname/sbsname) DEV(devname*) MODE(modename)
```

To specify the devices a communications subsystem **should not** allocate:

```
ADDCMNE SBSD(libname/sbsname) DEV(devname*) MODE(modename) MAXACT(0)
```

Note: Database and file servers run only in QSERVER when running over APPC. Do not attempt to allocate sessions running over the QSERVER mode description. These servers can run over TCP/IP and only then can you run them in subsystems other than QSERVER.

See the following example for a way of configuring your communications subsystem.

Example: Communications subsystem configuration:

1. Create a duplicate of QCMN:

```
CRTDUPOBJ OBJ(QCMN) FROMLIB(QSYS) OBJTYPE(*SBSD) TOLIB(MYLIB) NEWOBJ(MYCMN)
```

2. Set up the communication entries:

```
ADDCMNE SBSDB(MYLIB/MYCMN) DEV(PC*)  
ADDCMNE SBSDB(MYLIB/MYCMN) DEV(PC*) MODE(QSERVER) MAXACT(0)  
ADDCMNE SBSDB(QSYS/QCMN) DEV(PC*) MODE(QPCSUPP) MAXACT(0)
```

3. Finally, you can update your system startup program to start your new subsystems automatically.

Communications performance considerations for interactive jobs

An interactive job is one that uses a keyboard and character-type display. If a job needs the user to type on the keyboard and display character results, that job is probably considered interactive. Interactive in this sense means that the job and the user depend on each other to get the work done.

To optimize communications performance for interactive jobs, consider the following:

- Attach workstations through communications. This requires more CPU overhead than 5250 local workstations.
- Use a twinaxial controller to provide better performance than an American National Standard Code for Information Interchange (ASCII) controller.
- Keep the line utilization below 30 percent for best performance when interactive users are attached. This maintains predictable and consistent response times. Exceeding 50 to 60 percent line utilization will typically cause unacceptable response times.

If your system has interactive users who are connected many different ways, you should consider configuring your interactive subsystems to separate the users. Local workstation, remote workstations, 5250 display station pass-through, or Telnet are some examples of these types of connections that should be separated. When you configure interactive subsystems, identify how you want the interactive users to be separated and create the appropriate subsystem descriptions.

During error recovery, when many users risk losing their sessions at one time, an interactive subsystem can be very busy performing device recovery. This device recovery can adversely affect the work of other users in the subsystem who would otherwise be unaffected by the failure. Therefore, you might need to change how the interactive subsystems are configured. However, multiple subsystems can provide multiple processes to do cleanup and recovery when error conditions occur. This can result in improved performance.

The example below shows how to configure an interactive subsystem to allocate devices that begin with devname* and present a signon display on those display devices:

```
ADDWSE SBSDB(libname/sbsname) WRKSTNDEV(devname*) AT(*SIGNON)
```

Use the following example to configure an interactive subsystem so that the device name devname* is not allocated and a signon display does not appear.

```
ADDWSE SBSDB(libname/sbsname) WRKSTNDEV(devname*) AT(*ENTER)
```

Adding workstation entries with AT(*ENTER) allows you to use the Transfer Job (TFRJOB) function into that subsystem. If the TFRJOB function is not required or necessary, there is no need to add the workstation entries with AT(*ENTER).

To specify the devices an interactive subsystem **should** allocate when the subsystem is started:

```
ADDWSE SBSDB(libname/sbsname) WRKSTN(devname*) AT(*SIGNON)
```

To specify the devices an interactive subsystem **should not** allocate when the subsystem is started:

```
ADDWSE SBSDB(libname/sbsname) WRKSTN(devname*) AT(*ENTER)
```

- See the following example for a way of configuring your interactive subsystem.

Example: Interactive subsystem configuration:

1. Create a subsystem description:

```
CRTSBSD SBSDB(MYLIB/MYINTER) POOLS((1 *BASE) (2 *INTERACT))
```

2. Create a class

```
CRTCLS CLS(MYLIB/MYCLASS) RUNPTY(20)
```

3. add routing entries to your subsystem:

```
ADDRTGE SBSDB(MYLIB/MYINTER) SEQNBR(10) CMPVAL(QCMDI) PGM(QSYS/QCMD) POOLID(2)
ADDRTGE SBSDB(MYLIB/MYINTER) SEQNBR(9999) CMPVAL(*ANY) PGM(QSYS/QCMD) POOLID(2)
```

4. Create a job queue, and add the job queue entry to your new subsystem:

```
CRTJOBQ JOBQ(MYLIB/MYJOBQ)
ADDJOBQE SBSDB(MYLIB/MYINTER) JOBQ(MYLIB/MYJOBQ) MAXACT(200)
```

5. Set up the workstation name entries. Remove all the *ALL workstation type entries first, and then add the appropriate workstation name entries:

```
RMVWSE SBSDB(QSYS/QINTER) WRKSTNTYPE(*ALL)
ADDWSE SBSDB(QSYS/QINTER) WRKSTN(QPADEV*)
ADDWSE SBSDB(MYLIB/MYINTER) WRKSTN(PC*)
```

6. Finally, you can update your system startup program to start your new subsystems automatically.

Communications performance considerations for batch jobs

Each piece of work run on the iSeries system is called a job. Each job is a single, identifiable sequence of processing actions that represents a single use of the system. The basic types of jobs that are performed are interactive jobs, batch jobs, spooling jobs, autostart jobs, and prestart jobs.

Batch jobs are predefined groups of processing actions that are submitted to the system to be performed with little or no interaction between the user and the system. Batch jobs can be tuned for optimized performance.

To optimize batch jobs for communications, consider the following:

- Break the application into pieces and having multiple batch threads (jobs) operate concurrently.
- Reduce the number of open and close operations, input and output operations.
- If you have a considerable amount of main storage available, consider using the Set Object Access (SETOBJACC) command. This command preloads the complete database file, database index, or program into the assigned main storage pool if sufficient storage is available. The objective is to improve performance by eliminating disk-read/write operations.
- Try to limit the number of communications input and output operations by doing fewer (and perhaps larger) application sends and receives when communications lines are used.
- Block the data in the application. Try to place the application on the same system as the frequently accessed data.

For more information about batch job performance, see the Communications Management  book.

Mix interactive and batch jobs on a WAN line

When interactive users and large transfers are running on a communications line concurrently, you might need to change configuration parameters. You should be able to configure iSeries server communications to work with interactive and batch jobs.

To mix interactive and batch jobs on a wide area network (WAN) line, consider the following to keep interactive performance acceptable:

- Use Advanced Peer-to-Peer Networking (APPN) transmission priority to prioritize the interactive user's transfer over that of the large transfer. This is the preferred method to transfer batch and interactive jobs.

- Change the request/response unit size to a lower value for the large transfer. This parameter setting optimizes response time at the expense of large transfer performance.
- Reduce the pacing values for the large transfer to slow it down, which allows the interactive users more windows for getting on the line.

Note: The overall central processing unit time increases for the large transfer.

For more information about iSeries server communications, see the Communications Configuration  book.

AnyNet communications for the iSeries system

AnyNet is an IBM implementation of the Multiprotocol Transport Networking (MPTN) architecture, such as AnyNet/2 and AnyNet/Multiple Virtual Storage (MVS™). AnyNet capability allows applications and associated services that use application programming interfaces, such as sockets, intersystem communications function (ICF), or CPI Communications, the flexibility to use alternative network protocols, such as Systems Network Architecture (SNA) or TCP/IP. AnyNet is a family of products that allow applications that are written for one type of network protocol to run over a different type of network protocol. For example, without AnyNet, your choice of application programming interface (API) dictates your choice of network protocol, or your choice of network protocol dictates your choice of APIs.

AnyNet allows you to mix and match applications with network protocols. In fact, you can do this without changing your application programs. Your destination address (such as a remote location) determines the type of network protocol to use.

- AnyNet/400 Sockets

This support converts TCP/IP addresses to SNA addresses that are based on tables that are configured by the network administrator. Programs supported include File Transfer Protocol (FTP), Simple Mail Transfer Protocol (SMTP), Simple Network Management Protocol (SNMP), PING, and user-written sockets programs over SNA.

- AnyNet/400 APPC (advanced program-to-program communications)

This support allows programs that are written to traditional APPC APIs (such as ICF, CPI-Communications, and CICS/400) to be run over non-APPC networks. The application program uses **Location names** to specify the source and destination address. A TCP/IP domain name server converts these location names to IP addresses. Programs supported include distributed data management (DDM), Distributed Relational Database Architecture™ (DRDA®), SNA distribution services (SNADS), display station pass-through, iSeries Access for Windows®, user-written CPI-Communications programs, and user-written ICF programs over TCP/IP.

For more information about AnyNet, see:

“Set up the AnyNet environment”

“Performance considerations for AnyNet communications” on page 15

See also the Sockets Programming  book.

Set up the AnyNet environment

AnyNet/400 is an AnyNet family product. These products allow you to use application programs that are written for a certain communications protocol but also run over non-native communications protocols without changing (or even re-compiling) the application program. The choice of the destination address controls whether the request is sent over the native protocols or through the AnyNet code and on to a non-native protocol.

To configure Transmission Control Protocol/Internet Protocol (TCP/IP) over advanced program-to-program communications (APPC), you need to take two basic actions:

1. Identify the set of IP addresses to route over the SNA network.
2. Tell the system how to convert the IP address to the SNA format.

For more information about APPC Over TCP/IP Configuration, see the APPC Programming  book.

Performance considerations for AnyNet communications

AnyNet communications is a good performance factor for you to consider. It is more expensive to use than any of the i5/OS™ protocols because you spend twice as much to run two protocols.

To optimize AnyNet performance, consider the following:

- For send and receive pairs, the most efficient use of an interface is with its own protocol stack. That is, intersystem communications function (ICF) and common programming interface communications (CPI Communications) perform the best with advanced program-to-program communications (APPC). There is additional CPU time when the crossover between the protocols processes.
- Each communications interface performs differently depending on the scenario. ICF and CPI Communications perform the best with APPC.

Note: An alternative to AnyNet communications is to have SNA and TCP/IP running parallel or over the same lines in your network. Hence, performance implications can be surpassed by not using AnyNet.

See “AnyNet communications for the iSeries system” on page 14 for the answer to the question: What is AnyNet?

For more information about AnyNet/400 sockets, see the book Sockets Programming .

Enterprise Extender communications for the iSeries system

Enterprise Extender is a networking architecture that allows Systems Network Architecture (SNA) applications to run over Internet Protocol (IP) networks using High Performance Routing (HPR). This is the preferred way to run SNA applications over IP networks with communications input/output adapters (IOAs), such as Gigabit Ethernet, since these IOAs do not require an input/output processor (IOP). Communications adapters that do not use an IOP do not support SNA, therefore, Enterprise Extender is required to run SNA over these adapters. IBM recommends that Enterprise Extender be used in place of AnyNet.

Set up the Enterprise Extender environment

To configure HPR to run over Internet Protocol (IP) networks, you need to do these tasks:

1. Configure your TCP/IP network
2. Create an APPC controller description and specify link type *HPRIP. See Create an APPC controller description in the APPC, APPN, and HPR topic collection to do this.

Migration from AnyNet to Enterprise Extender

IBM recommends that Enterprise Extender be used in place of AnyNet. To do the conversion, you have to migrate existing AnyNet configurations to the HPRIP controllers. The following should be taken into account:

- While AnyNet can handle several remote links with only one controller, Enterprise Extender needs one HPRIP controller for each remote node that has a direct link. A new controller description must be created for each remote node that is being migrated from AnyNet.
- AnyNet provided low-entry networking (LEN) functions, and not full APPN support. Enterprise Extender HPRIP controller provides full APPN functions. Remote definitions on the configuration lists need to be deleted.
- TCP host definition entries are no longer required for Enterprise Extender because the mapping is done in the controller definition.
- AnyNet and Enterprise Extender can coexist, and there can even be parallel configurations of AnyNet and Enterprise Extender during the migrations.

| To perform a migration from AnyNet to Enterprise Extender, see the following topics:

- | "Migration for a system that can start AnyNet connections"
- | "Migration for a system that cannot start AnyNet connections"
- | "Parallel configurations of AnyNet and Enterprise Extender"

| **Migration for a system that can start AnyNet connections:** You should have the following network configuration items defined:

- | • One APPC controller of type *ANYNW, that has a remote control point value of TCPIP.
- | • One entry on the QAPPNRMT configuration list for each remote node that defines the remote node and sets the control point name as TCPIP.
- | • One entry on the TCP Host table that has the "SNA.IBM.COM" suffix, and the remote SNA host name and remote network ID that has the same suffix.
- | • The ALWANYNET network attribute set to *YES.

| To migrate to HPRIP, do the following:

- | 1. For each entry on the host table that has an SNA.IBM.COM suffix, create one APPC controller of the link type of *HPRIP, and the IP address of the remote host using the CRTCTLAPPC CL command.
- | 2. Using either the RMVCFGLE or WRKCFGLE *APPNRMT CL command, delete the entry for the remote system on the QAPPNRMT configuration list.

| The entry on the host table can be kept or deleted.

| *Migration for a system that cannot start AnyNet connections:* You should have the following network configuration items defined:

- | • One APPC controller of type *ANYNW
- | • The ALWANYNET network attribute set to *YES

| You then have to manually create an HPRIP controller for each remote node that needs to access the system.

| **Parallel configurations of AnyNet and Enterprise Extender:** It is possible to migrate to Enterprise Extender while maintaining existing AnyNet definitions, but a new remote logical unit (LU) must be defined to handle AnyNet connections. The following example explains how this is done.

| For this example, assume that you have two systems: SYSA and SYSB. SYSA has the following configuration:

- | • One APPC controller of type *ANYNW that has a remote control point value of TCPIP.
- | • One entry on the QAPPNRMT configuration list for each remote node that defines the remote node and sets the control point name as TCPIP.
- | • One entry on the TCP Host table added that has the "SNA.IBM.COM" suffix, and the remote SNA host name and remote network ID that has the same suffix.
- | • The ALWANYNET Network attribute set to *YES.

| When migrating from AnyNet to HPRIP, you need to create a new LU on SYSB and SYSA. In this example, the new LUs are called ANYSYSA and ANYSYSB.

| If the QAPPNLCL configuration list has not been created on SYSA, create the new LU by issuing the following command:

```
| CRTCGI TYPE(*APPNLCL) APPNLCL((ANYSYSA 'HPRIP LU'))
```

| If the QAPPNLCL configuration list already exists, then use this command:

```
| CHGCGL TYPE(*APPNLCL) APPNLCL((ANYSYSA 'HPRIP LU'))
```

| Then the configuration list entries for the remote must be changed. First, add the new remote LU to the configuration list with the following CL command:

```
| ADDCFGLE TYPE(*APPNRMT) APPNRMTE((ANYSYSB *NETATR ANYSYSA TCPIP *NETATR))
```

| Next, the SYSB entry must be removed from the configuration list using this command:

```
| RMVCFGLE TYPE(*APPNRMT) APPNRMTE((SYSB *NETATR SYSA))
```

| The equivalent commands should be issued on SYSB. Then controllers should be created for SYSB in SYSA and for SYSA in SYSB using the CRTCTLAPPC CL command.

| After this is accomplished, you should be able to start sessions to LU SYSB, in which case the communications media would be Enterprise Extender. For AnyNet communications, ANYSYSB LU should be used.

Subsystems

A subsystem is a single, predefined operating environment through which the system coordinates work flow and resource usage. i5/OS can contain several that are independent operating subsystems. The run-time characteristics of a subsystem are defined in an object that is called a subsystem description. IBM supplies several subsystem descriptions that can be used with or without modification:

QINTER

Used for interactive jobs

QBATCH

Used for batch jobs

QBASE

Used for both interactive and communications batch jobs

QCMN

Used for communications batch jobs

QSERVER

File server system

QSYSWRK

Used for general system work

QUSRWRK

Used to run TCP/IP server jobs that do work on behalf of a specific user.

A new subsystem can also be defined with the Create Subsystem Description (CRTSBSD) command.

For more information about creating subsystems, see the Work Management  book.

Communications applications

Communications applications that are used in an APPC (advanced program-to-program) environment are also available to be used in an APPN and HPR environment; only the method by which data is transported is changed. APPC delivers the data from applications higher in the SNA layers down to APPN for transportation through the network. For more information on communications applications, see the following:

- “User-written APPC applications” on page 18
- “Distributed data management (DDM)” on page 18

- “Application programming interface (API) performance considerations”

When you encounter problems that indicate that the route to the remote location cannot be found, you can attempt to make the connection again with the Start Pass-Through (STRPASTHR) command. See the Solve remote communication problems using STRPASTHR topic for more information.

For information on Connecting Windows XP/2000 Clients to your iSeries server, see iSeries Access.

User-written APPC applications

APPN performs many functions in a communications environment. Therefore, it is important to consider time-out parameters in APPC programs which use ICF. In particular, it may be important to increase the WAITFILE parameter for these applications so that they do not time-out while waiting for APPN functions to be performed.

APPN function is not apparent to APPC programs. APPN takes advantage of the following routing functions:

- Non-adjacent nodes appear adjacent and so APPC programs may communicate directly to programs in non-adjacent nodes (without any APPC programs on the intermediate nodes).
- Performance is improved for APPC programs with session endpoints that are not physically adjacent in the network.
- APPC programs may communicate directly to programs in nodes in an adjacent APPN network through network nodes.

Distributed data management (DDM)

DDM is a function of the operating system that allows an application program or user on one system to use database files stored on remote systems. The systems must be connected by a communications network, and the remote systems must also be using DDM.

DDM on the iSeries server allows application programs or users to:

- Access data files that reside on remote systems (target systems). The remote systems can also access data files on the local iSeries system.
- An application can add, change, and delete data records in a file that exist on a target system.
- Create, delete, or rename files on a remote system.
- Copy a file from one system to another.

When DDM is in use, neither the application program nor the program user needs to know if the file that is needed exists locally or on a remote system. Remote and local file processing are essentially handled the same way.

For more information on DDM, see the following:

- Distributed Data Management (SC41-5307).

Application programming interface (API) performance considerations

To achieve better performance with your iSeries server, you need to consider the application programming interface (API) available on the iSeries server. To optimize APPC performance, consider the following:

- Using larger sends (record sizes) for a large transfer provides a higher application data rate and decreases CPU time. With the larger record size, the CPU has less processing to do because there are fewer application reads and writes to transfer the same amount of data.
- If a value of *CALC is selected for maximum Systems Network Architecture (SNA) request/response unit (RU), the system selects an efficient size compatible with the frame size. The frame size is on the line description that you choose. Changing the RU size to a value other than *CALC may negate this performance feature.

- Compression with APPC should be used with caution and only for slower speed wide area network (WAN) environments. Many suggest that compression should be used with speeds 19.2 kbps and slower.
- If you are doing tasks that include repetitive, small puts; better performance is achieved if you use ICF or CPI Communications.

See the following topics for a more complete discussion of APPC applications:

- Performance considerations for Intersystem Communications Function
- Performance considerations for Common Programming Interface communications

For information about iSeries server communications, see the Communications Configuration  book.

For more information about CICS/400, see the CICS for iSeries Administration and Operations Guide



Performance considerations for intersystem communications function

You can use intersystem communications function (ICF) to write application programs that you want to communicate with advanced program-to-program communications (APPC). ICF also provides program-to-device communications between the iSeries system and hardware devices. You must determine which system is to send data first before you write the program. ICF data management handles the communication functions and the data for your program. In particular, ICF should be used to do tasks that include repetitive, small inputs.

To optimize ICF performance, consider the following:

- Eliminate unused record formats.
- Use separate record formats instead of multipurpose record formats with option indicators.
- Code to use the same record format for repeated operations.
- Set the maximum program devices equal to 1.
- Use a nonshared file.
- Use a separate indicator area.
- The use of the ICF keywords force data and confirm should be minimized.
- Use the Request to Send keyword only when necessary.
- Use the Invite Only keyword when soliciting input from multiple devices, otherwise use the Read keyword instead.
- If using the Invite keyword to solicit from multiple program devices, follow it with a Read-from-invited operation, not a Read operation.

To create device descriptions to get your system set up for ICF, do the following:

1. Type the appropriate Create Device Description commands on the iSeries system command line and press F4.
2. Use the online help information to choose the parameter values.
3. Press Enter. The device description is created.

For more information about ICF, see

- “Application programming interface (API) performance considerations” on page 18

- ICF Programming 

Performance considerations for Common Programming Interface Communications

You can use Common Programming Interface Communications (CPI Communications) to write application programs that you want to communicate with advanced program-to-communications (APPC). The interface makes use of the System Network Architecture (SNA) LU (logical unit) 6.2 architecture to do the following:

- Establish a conversation
- Send and receive data

- Exchange control information
- End a conversation
- Notify a partner program of errors.

Intersystem communications feature (ICF) and CPI Communications programs have similar performances for small data transfers.

To optimize CPI Communications application programs, do the following:

- Minimize the use of flush and confirm.
- Receive a compile record and parse it in your buffer.
- Do not use multiple receive calls to receive a single record.
- Use Request-to-Send only when necessary.

To add or change communications entries to get the system set up for CPI Communications, do the following:

1. Type appropriate command on the iSeries system command line and press F4.
 - Add Communications Entry (ADDCMNE)
 - Remove Communications Entry (RMVCMNE)
 - Change Communications Entry (CHGCMNE)
2. Use the online help information to change, add, or remove parameter values.
3. Press Enter. The communications entries are added, changed or removed.

For more information about configuring CPI Communications, see:

- “Application programming interface (API) performance considerations” on page 18
- CICS/400 Administration and Operations Guide 

Communicate with host systems

You can configure the iSeries system to communicate with a host system by matching iSeries system parameters. Another option for iSeries system users is Dependent LU Requester Support (DLUR). DLUR allows dependent secondary logical units (LU 0, 1, 2, and 3) an entry point into the APPN network. DLUR support gives the appearance of having an adjacent connection to VTAM, but allows traversing the APPN network through intermediate nodes. For more information on these options to communicate with host systems, see the following:

- “Match iSeries system parameters for a host system”
- “Configure dependent LU requester (DLUR)” on page 31

Match iSeries system parameters for a host system

You can configure the iSeries system to communicate with a host system. This configuration requires the coordination of parameters and values. The list contains only those configuration prompts and parameters that require coordination on both the iSeries system and the host system. In addition, some of the parameters that are listed may not apply to your particular configuration.

For examples of connecting an iSeries system to a host system, see “Examples: Connect iSeries server to a host server” on page 25.

For information about configuring host systems, see the manuals *VTAM Installation and Resource Definition*, SC23-0111, and *Network Control Program Resource Definition Reference*, SC30-3254.

- “Match iSeries system line description parameters for a host system” on page 21
- “Match iSeries system controller description parameters for a host system” on page 22
- “Match iSeries system device description parameters for a host system” on page 24
- “Match iSeries system mode and class-of-service description parameters for a host system” on page 25
- For more information on iSeries system parameters, see Communications Configuration .

Match iSeries system line description parameters for a host system

You must match host system communications configuration parameters with iSeries system values. A description of these iSeries system values are in the following table. For information about configuring host systems, see the manuals *VTAM Installation and Resource Definition*, SC23-0111, and *Network Control Program Resource Definition Reference*, SC30-3254.

You can specify some host system parameters on multiple definition statements, such as the GROUP, LINE, PU, and LU. The following table lists only the lowest level definition statement that is used by the host system.

To configure an iSeries system to a host system:

- See “Examples: Connect iSeries server to a host server” on page 25 for an example of connecting an iSeries system to a host system.
- Use the following table for the line description parameter.

iSeries Prompt	iSeries Parameter	Host Definition Statement	Host Parameter
Local adapter address	ADPTADR	PATH	DIALNO Host DIALNO parameter is a concatenation of: SSAP/DSAP/ <i>remote-adapter-address</i> . iSeries CRTLINTRN command ADPTADR value must match the <i>remote-adapter-address</i> portion of the host DIALNO parameter. The DSAP portion of the DIALNO parameter must correspond to the SSAP value specified on the iSeries controller description.
		PU	MACADDR For 9370/LAN only, the iSeries line description ADPTADR must match the host MACADDR parameter. MACADDR can be coded as an 8- or 12-digit hexadecimal number; the 8-digit variation assumes 4000 in the first four positions (4000xxxxxxxx).
Connection type	CNN	GROUP	DIAL If the iSeries line description CNN parameter is *SWTPP or *SHM, DIAL=YES must be specified for the host system; if CNN is *MP or *NONSWTPP, DIAL=NO must be specified. If CNN(*MP) is specified, the SERVICE macroinstruction must be used to specify the sequence in which stations are served.
Exchange identifier	EXCHID	PU	IDBLK, IDNUM The iSeries block number (digits 1-3 of the EXCHID) is always 056. The remaining 5 digits (based on the system serial number if *SYSGEN is used) are specified in the IDNUM parameter.
Line speed	LINESPEED	LINE	SPEED Line speeds specified for each system must match.
Maximum frame size	MAXFRAME	PU	MAXDATA Values specified for each system must match.

iSeries Prompt	iSeries Parameter	Host Definition Statement	Host Parameter
NRZI data encoding	NRZI	LINE	NRZI Values specified for each system must match.
Station address	STNADR	PU	ADDR iSeries system station address must be unique within host PU definitions. (Ignored within 9370/LAN environment.)

For more information on iSeries system parameters, see Communications Configuration .

For steps on how to create a line description, see “Create a line description” on page 6.

Match iSeries system controller description parameters for a host system

You must match host system communications configuration parameters with iSeries system values. A description of the iSeries system values are in the following table. For information about configuring host systems, see the manuals *VTAM Installation and Resource Definition*, SC23-0111, and *Network Control Program Resource Definition Reference*, SC30-3254.

You can specify some host system parameters on multiple definition statements, such as the GROUP, LINE, PU, and LU. The following table lists only the lowest level definition statement that is used by the host system.

To configure an iSeries system to a host system:

- See “Examples: Connect iSeries server to a host server” on page 25 for an example of connecting an iSeries system to a host system.
- Use the following table for the controller description parameter.

iSeries Prompt	iSeries Parameter	Host Definition Statement	Host Parameter
Adjacent link station	ADJLNKSTN	PU	<i>name</i> iSeries adjacent link station name must match the name assigned to the PU macro instruction in the host system switched major node definition. This match is required if iSeries host controller description specifies RMTCPNAME(*ANY), SWITCHED(*YES) or SNBU(*YES), and LINKTYPE is *SDLC. This parameter should be specified only if the host system is running VTAM Version 4 Release 1 or later and NCP Version 6 Release 2 or later.
LAN remote adapter address	ADPTADR	LINE	LOCADD Values specified for each system must match. If LOCADD is specified, ECLTYPE=PHYSICAL must also be specified on the GROUP definition statement.
		PORT	MACADDR For 9370/LAN only, the iSeries controller description ADPTADR must match the host MACADDR parameter. MACADDR can be coded as an 8- or 12-digit hexadecimal number; the 8-digit variation assumes 4000 in the first four positions (4000xxxxxxx).

iSeries Prompt	iSeries Parameter	Host Definition Statement	Host Parameter
Destination service access point	DSAP	PORT	SAPADDR For 9370/LAN only, the iSeries controller description DSAP must match the host SAPADDR parameter. The SAPADDR parameter is a decimal value (4-252); the iSeries value is specified as a 2-digit hexadecimal number.
Local exchange identifier	LCLEXCHID	PU	IDBLK, IDNUM For parallel connections only. Required if the iSeries system specifies RMTCPNAME(*ANY), SWITCHED(*YES), and LINKTYPE is *SDLC. The LCLEXCHID specified must match the values specified in the switched major node definition PU macro instruction.
Maximum frame size	MAXFRAME	GROUP	MAXDATA Values specified for each system must match.
Remote control point name	RMTCPNAME	VTAMLST	SSCPNAME Required only if APPN(*YES). iSeries controller description value must match SSCPNAME specified in the Virtual Telecommunications Access Method (VTAM) start options list (ATCSTRyy).
Remote network identifier	RMTNETID	VTAMLST	NETID Required only if APPN(*YES). iSeries controller description value must match NETID specified in the VTAM start options list (ATCSTRyy).
Source service access point	SSAP	PU	SAPADDR For 9370/LAN only, the iSeries controller description DSAP must match the host SAPADDR parameter. The SAPADDR parameter is a decimal value (4-252); the iSeries value is specified as a 2-digit hexadecimal number.
SSCP identifier	SSCPID	VTAMLST	SSCPID Required if APPN(*YES) or if RMTCPNAME is not specified. iSeries controller description value must match SSCPID specified in the VTAM start options list (ATCSTRyy). The SSCPID parameter is a decimal value (0-65535); the iSeries value is specified as a 12-digit hexadecimal number, of which the first 2 digits are 05.
Station address	STNADR	PU	ADDR iSeries system station address must be unique within host PU definitions. Controller description STNADR must match the value specified in the line description.

For more information on iSeries system parameters, see Communications Configuration .

Match iSeries system device description parameters for a host system

You must match host system communications configuration parameters with iSeries system values. A description of the iSeries system values are in the following table. For information about configuring host systems, see the manuals *VTAM Installation and Resource Definition*, SC23-0111, and *Network Control Program Resource Definition Reference*, SC30-3254.

You can specify some host system parameters on multiple definition statements, such as the GROUP, LINE, PU, and LU. The following table lists only the lowest level definition statement that is used by the host system.

To configure an iSeries system to a host system:

- See “Examples: Connect iSeries server to a host server” on page 25 for an example of connecting an iSeries system to a host system.
- Use the following table for the device description parameter.

iSeries Prompt	iSeries Parameter	Host Definition Statement	Host Parameter
Local location name	LCLLOCNAME	DFHTCT	NETNAME iSeries LCLLOCNAME value must match CICS/VS terminal control table NETNAME parameter and the label used on the LU definition statement.
Local location address	LOCADR	LU	LOCADDR Values specified for each system must match. The LOCADDR parameter is a decimal value (0-255); the iSeries value is specified as a 2-digit hexadecimal number.
Location password	LOCPWD	DFHTCT	BINDPWD Values specified for each system must match.
Dependent location name	DEPLOCNAME	LU	LU This parameter is only used for DLUR support. This value is optional. If specified, it must match LUNAME received on ACTLUREQUEST.
Mode description name	MODE	MODEENT	LOGMODE iSeries mode description name must be defined in the host logon mode table using the LOGMODE parameter on the MODEENT macro instruction. The mode name must also be included in the CICS/VS terminal control table (DFHTCT) MODENAM parameter.
Remote location name	RMTLOCNAME	LU	LOGAPPL Values specified for each system must match.
Remote network identifier	RMTNETID	BUILD	NETID Values specified for each system must match.

For more information on iSeries system parameters, see Communications Configuration. 

Match iSeries system mode and class-of-service description parameters for a host system

You must match host system communications configuration parameters with iSeries system values. A description of the iSeries system values are in the following table. For information about configuring host systems, see the manuals *VTAM Installation and Resource Definition*, SC23-0111, and *Network Control Program Resource Definition Reference*, SC30-3254.

You can specify some host system parameters on multiple definition statements, such as the GROUP, LINE, PU, and LU. The following table lists only the lowest level definition statement that is used by the host system.

To configure an iSeries system to a host system:

- See “Examples: Connect iSeries server to a host server” for an example of connecting an iSeries system to a host system.
- Use the following table for the mode and class-of-service description parameter.

iSeries Prompt	iSeries Parameter	Host Definition Statement	Host Parameter
Mode description name	MODD	MODEENT	LOGMODE iSeries mode description name specified on the iSeries CRTMODD command (MODD parameter) must be defined in the host logon mode table using the LOGMODE parameter on the MODEENT macro instruction. The mode name must also be included in the CICS/VS terminal control table (DFHTCT) MODENAM parameter.
Class-of-service description name	COSD	MODEENT	COS iSeries class-of-service description name specified on the iSeries Create Class-of-Service Description (CRTCOSD) command (COSD parameter) and CRTMODD command (COS parameter) must be defined in the host logon mode table using the COS parameter on the MODEENT macro instruction. The class-of-service description must also be defined in the VTAM class-of-service table.

For more information on iSeries system parameters, see Communications Configuration .

Examples: Connect iSeries server to a host server: Configuration parameters must be coordinated when you connect an iSeries system to a host system.

Example: iSeries system to host system over a nonswitched SDLC line.

The following figure shows the iSeries system values that need to match the VTAM values when you use a nonswitched SDLC line.

Read a description of this figure at “Example details: iSeries to host server connection over a nonswitched SDLC line” on page 80.

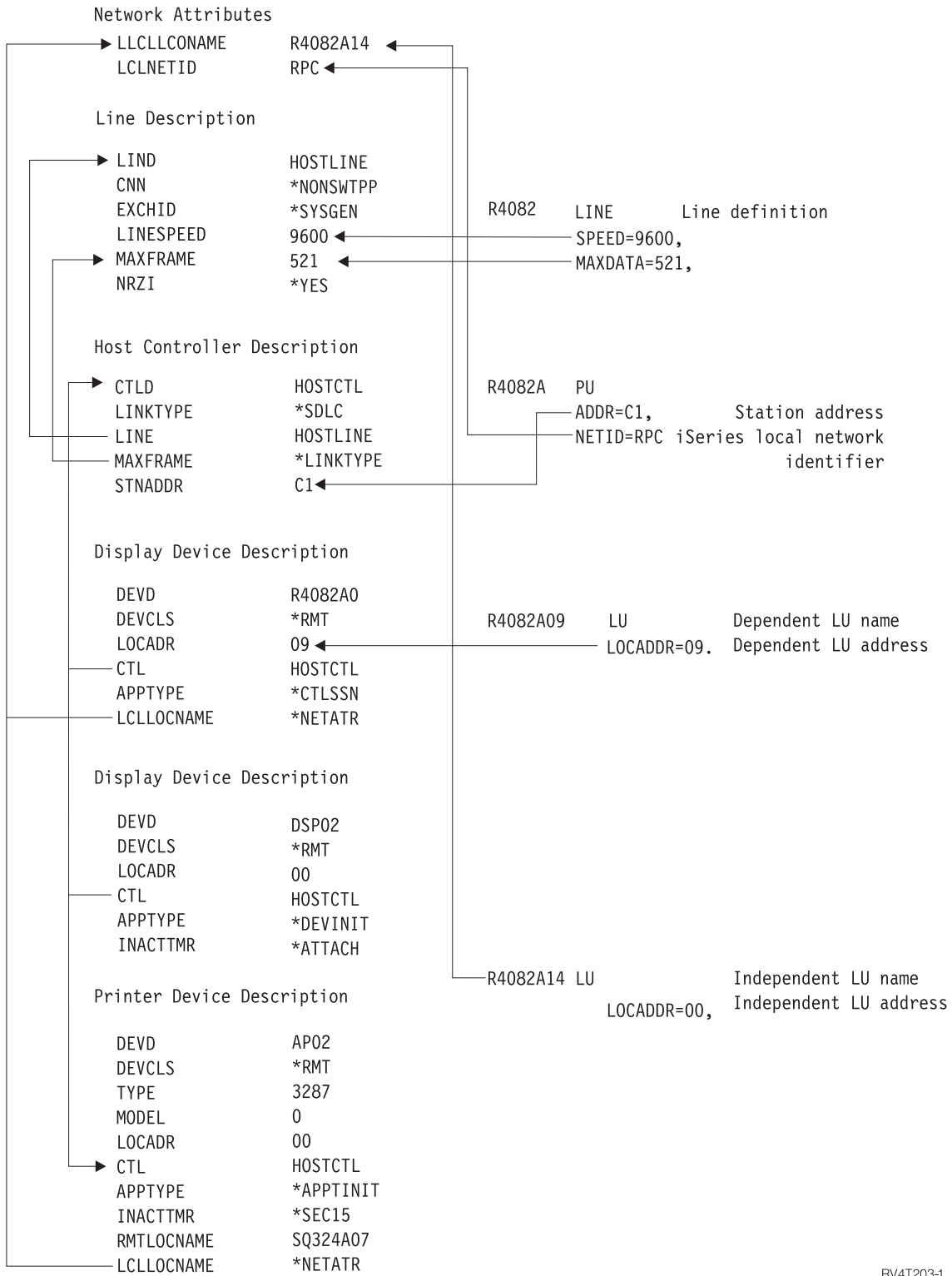

RV4T203-1

Figure 1. Figure showing how configuration parameters are related and configured. Follow the above link to detailed description for more information.

Example: iSeries system to host system over a token ring line

The following figure shows the iSeries system values that need to match the VTAM values when you use a token-ring line.

Read a description of this figure at “Example details: iSeries to host server connection over a token-ring line” on page 81.

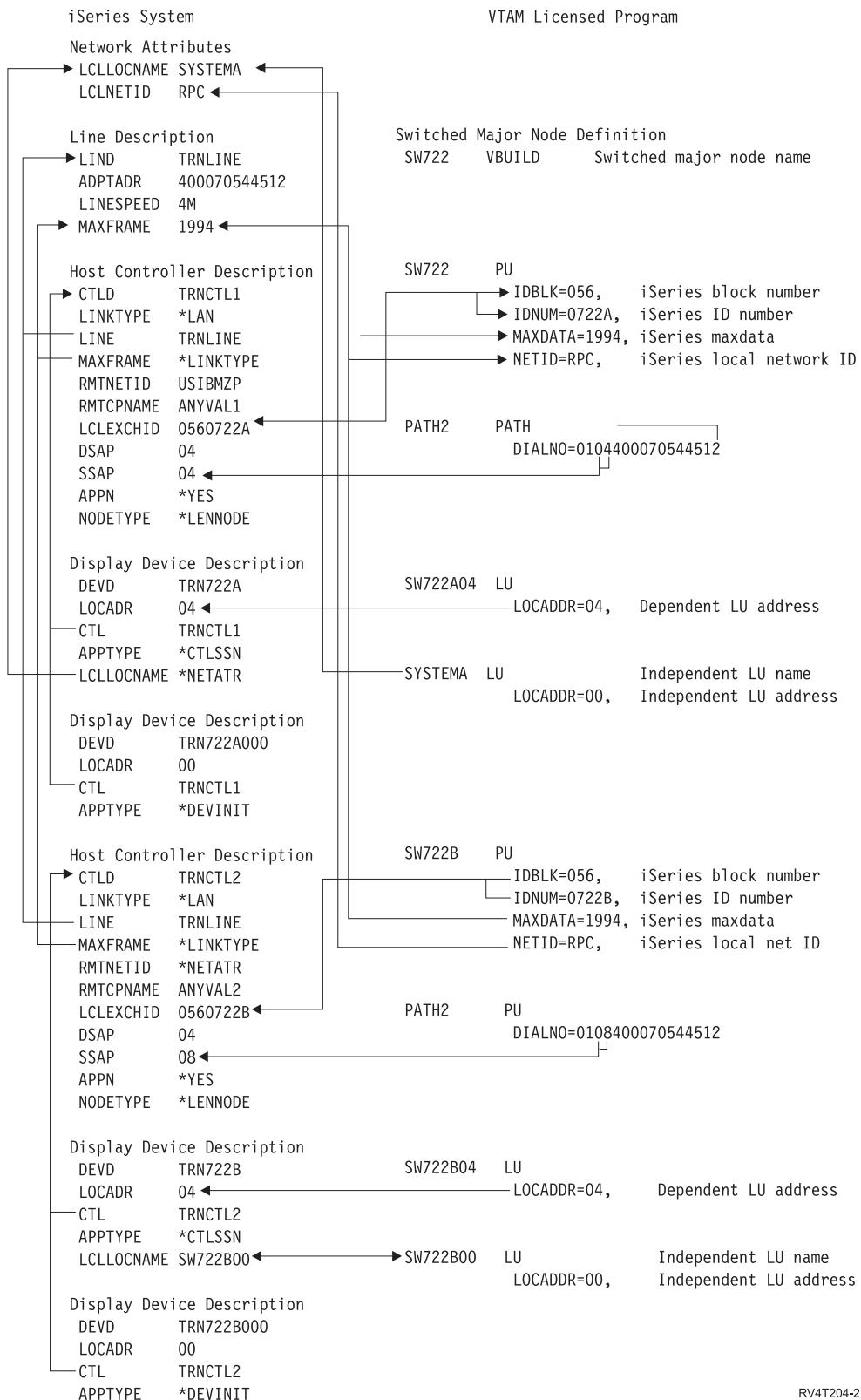

RV4T204-2

Figure 2. Figure showing how configuration parameters are related and configured. Follow the above link to detailed description for more information.

Example: iSeries system for DLUR support with the host system

The following figure shows the iSeries system values that need to match the VTAM values when you use iSeries system DLUR and VTAM.

Read a description of this figure at “Example details: iSeries server DLUR support with connection to the host server” on page 82.

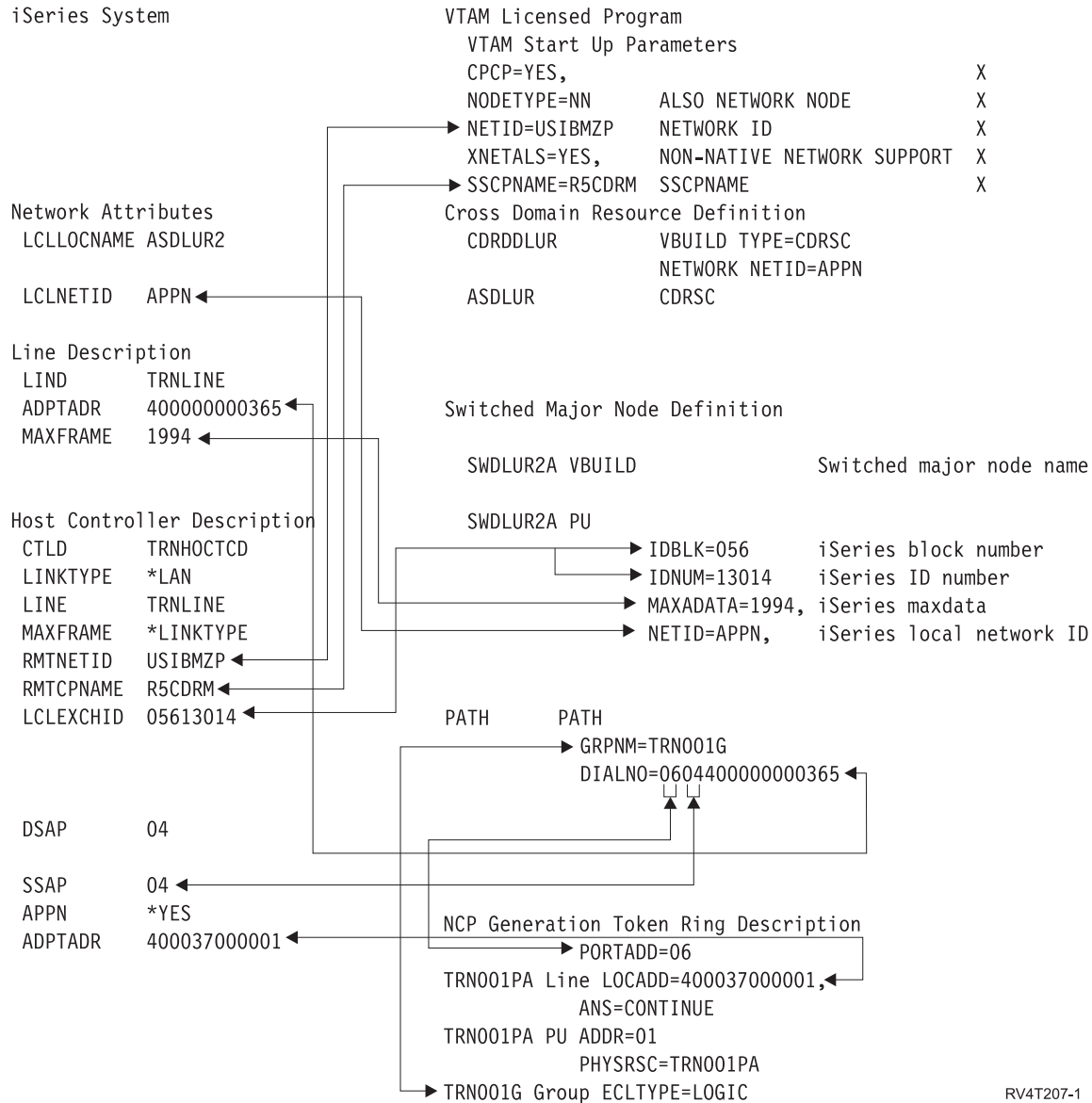
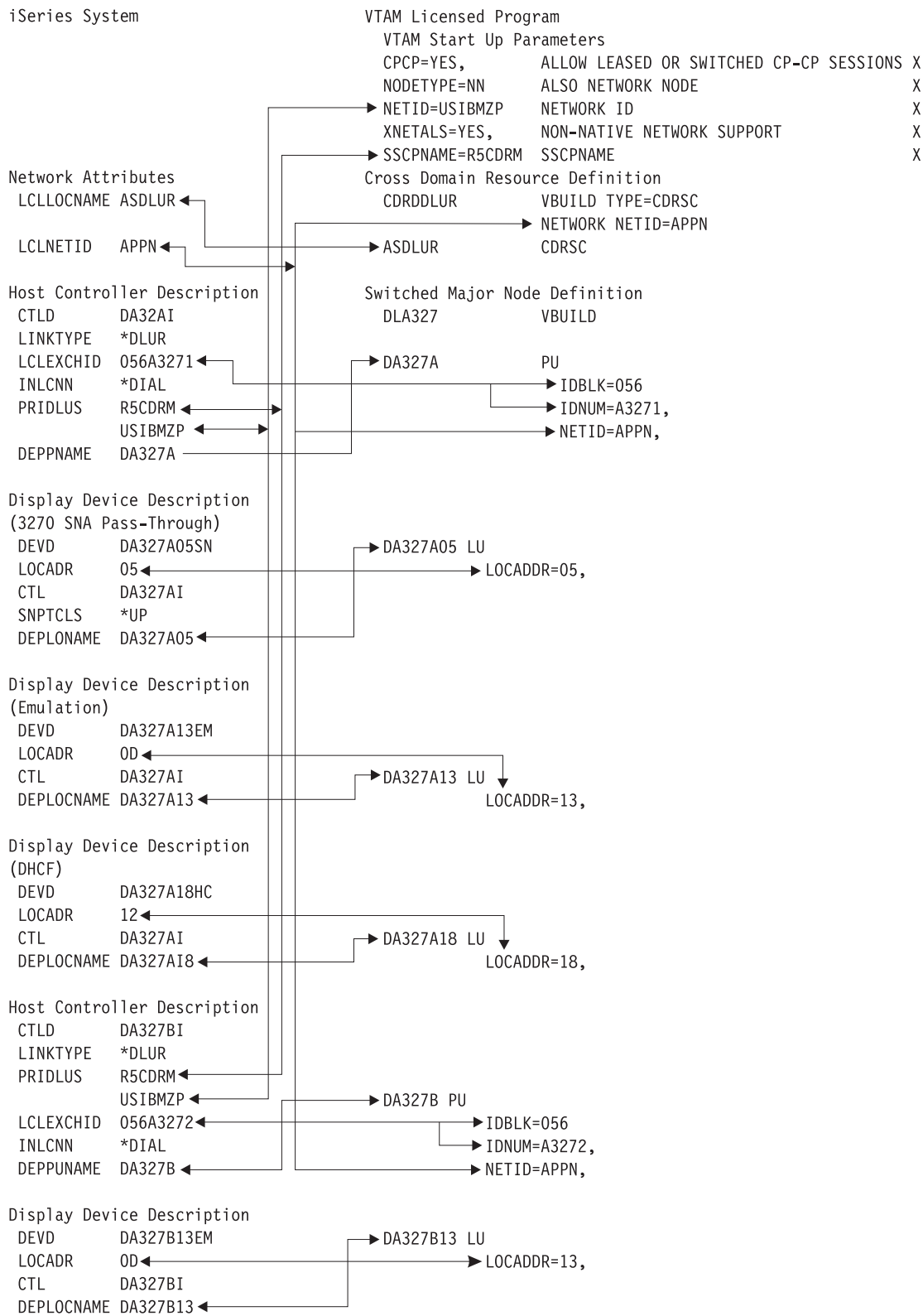

Figure 3. Figure showing how configuration parameters are related and configured. Follow the above link to detailed description for more information.

Example: iSeries server with APPN connection to VTAM

The following figure shows the iSeries system values that need to match the VTAM values when you connect with APPN.

Read a description of this figure at “Example details: iSeries server with APPN connection to VTAM” on page 82.



RV4T206-1

Figure 4. Figure showing how configuration parameters are related and configured. Follow the above link to detailed description for more information.

Configure dependent LU requester (DLUR)

Dependent LU Requester (DLUR) allows dependent secondary logical units (LU 0, 1, 2, and 3) an entry point into the APPN network. DLUR support gives the appearance of having an adjacent connection to VTAM, but allows traversing the APPN network through intermediate nodes.

Note: DLUR uses logmode CPSVRMGR. This is created internally as part of the APPN and DLUR support. If CPSVRMGR exists as a user-defined logmode on any of the systems in your network, it must be deleted. Use the Work with Mode Descriptions (WRKMODD) command and specify the option to delete CPSVRMGR.

To configure the iSeries server to communicate with DLUR, perform these steps:

1. Configure a host controller description
2. Configure device descriptions
3. Verify that an APPN connection into the network exists (host or APPC controller with *YES specified for the APPN parameter).

Configure the host controller description

Use the Create Controller Description (SNA Host) (CRTCTLHOST) command to create the controller description. If you have already created a controller description for such functions as 3270 emulation or NRE, you must change the link type to *DLUR. Follow these steps:

1. Retrieve the configuration description for the Dependent LU Requester (DLUR) controller description using the Retrieve Configuration Source (RTVCFGSRC) command.
2. Edit the member to change the link type to *DLUR.
3. Convert the source to a CL program.
4. Create the CL program using the CRTCLPGM command.
5. Delete the configuration using the DLTCTLD command.
6. Call the CL program to create the new configuration.

An explanation of some of the fields on the Create Controller Description (SNA Host) (CRTCTLHOST) screen are as follows:

Local exchange identifier

Matches the ID block and ID number parameters from the PU definition on VTAM.

Dependent PU name

Matches the name of the PU specified on the PU definition on VTAM.

Note: If the local exchange identifier and the dependent PU name are specified, both must match the definitions on VTAM. If both parameter values do not match, the ACTPU will be rejected.

If the *DIAL value is specified for the INLCNN parameter, the primary DLUS name (PRIDLUS), and either the local exchange identifier (LCLEXCHID), or the dependent PU name (DEPPUNAME) must be specified.

Control point name and network identifier for the primary DLUS name

Matches the SSCP name and NETID parameters on the VTAM startup options.

For the last step see, Configure the device descriptions.

Configure the device descriptions

Use the Create Device Description (CRTDEV DSP) command to create the device.

Dependent location name

Matches the LU name on the LU definition on VTAM.

Note: This must match the VTAM LU name with the corresponding local location address (LOCADDR) on VTAM.

For more information on DLUR see, Dependent LU Requester Support (DLUR).

Communicate with a remote iSeries server

Using advanced program-to-program communications (APPC) you can configure the iSeries server to communicate with another iSeries server. This configuration requires the coordination of configuration parameters and values. Only those configuration prompts and parameters that require coordination on both the local and remote iSeries servers are listed. In addition, some of the parameters that are listed may not apply to your particular configuration. See the following topics for more information:

- “Match iSeries system line description parameters for a remote iSeries system”
- “Match iSeries system controller description parameters for a remote iSeries system” on page 34
- “Match iSeries system device description parameters for a remote iSeries system” on page 35
- “Connect one iSeries server to another iSeries server” on page 36

For more information on iSeries system parameters, see the Communications Configuration  book.

Match iSeries system line description parameters for a remote iSeries system

You must coordinate communications configuration parameters between local and remote iSeries systems. These parameters are described in the following table. This table shows those prompts and parameters that must be coordinated when you specify line descriptions for the local and remote iSeries systems.

To configure a local iSeries server to a remote iSeries server:

- See “Connect one iSeries server to another iSeries server” on page 36 for an example of connecting one iSeries server to another iSeries server.
- Use the following table for the line descriptions.

iSeries system Prompt	iSeries Parameter	Remote iSeries Parameter	Notes
Local adapter address	ADPTADR	ADPTADR	Adapter address of the local system (specified on the line description) must be matched at the remote system in the controller description ADPTADR parameter. If the iSeries system uses an Ethernet line through an 8209 LAN Bridge, see “Appendix C: Local Area Network Addressing Considerations” in the Communications Configurationbook.
Insert network address in packets	ADRINSERT	ADRINSERT	If X.25 DCE support is specified (X25DCE(*YES) or X25DCE(*NEG)), ADRINSERT(*YES) should be specified for both systems.
Data bits per character	BITSCHAR	BITSCHAR	Values specified for each system must match.
Connection initiation	CNNINIT	CNNINIT	If X.25 DCE support is specified (X25DCE(*YES)) for either system, CNNINIT(*LOCAL) should also be specified on that system’s line description. The other system (with X25DCE(*NO) specified) should specify CNNINIT(*REMOTE) or CNNINIT(*WAIT). For switched connections, both systems can also specify X25DCE(*NEG) to negotiate the Distributed Computing Environment (DCE) and data terminal equipment (DTE) roles and CNNINIT(*CALLER) to allow either system to initiate the connection by making the call. See the X25DCE parameter for additional considerations.

iSeries system Prompt	iSeries Parameter	Remote iSeries Parameter	Notes
Duplex	DUPLEX	DUPLEX	Depending on the type of communications used, the values specified for the DUPLEX parameters may need to be coordinated.
Ethernet standard	ETHSTD	ETHSTD	Values specified for each system must be coordinated. Both systems must specify the same standard (*ETHV2 or *IEEE8023) or at least one system must specify *ALL.
Exchange identifier	EXCHID	EXCHID	Remote iSeries controller description EXCHID must match the local iSeries line description EXCHID. The first three digits of the exchange identifier, known as the block number, is 056 for the iSeries line. You can use the Work with Line Descriptions (WRKLIND) command to determine this value.
Logical channel entries	LGLCHLE	LGLCHLE	If X.25 DCE support is specified (X25DCE(*YES) or X25DCE(*NEG)), logical channel types and channel numbers must be coordinated. See also the considerations for the X25DCE parameter.
Line speed	LINESPEED	LINESPEED	For asynchronous lines, the line speeds specified for each system must match.
Modulus	MODULUS	MODULUS	If X.25 DCE support is specified (X25DCE(*YES) or X25DCE(*NEG)), modulus values specified for each system must match. The values specified for this parameter should match for all communications types.
Local network address	NETADR	CNNNBR	For switched virtual circuits (SVCs), the NETADR parameter on the local system line description must match the CNNNBR parameter on the <i>controller description</i> for the remote system.
NRZI data encoding	NRZI	NRZI	Values specified for each system must match (*YES or *NO).
Data link role	ROLE	ROLE	The value specified for the local system line description ROLE parameter should match the controller description ROLE parameter specified at the remote system.
Number of stop bits	STOPBITS	STOPBITS	Values specified for each system must match.
Switched connection type	SWTCNN	SWTCNN	Values specified for each system must be compatible. (*DIAL or *ANS must not be specified for <i>both</i> systems.)
X.25 DCE support	X25DCE	X25DCE	If X.25 DCE support is used (X25DCE(*YES)), only one of the iSeries line descriptions should specify *YES. The system specifying X25DCE(*YES) should also specify CNNINIT(*LOCAL); the other iSeries server should specify X25DCE(*NO) and CNNINIT(*REMOTE) or CNNINIT(*WAIT). For switched connections, both systems can also specify X25DCE(*NEG) to negotiate the DCE and DTE roles, and CNNINIT(*CALLER) to allow either system to initiate the connection by making the call.

For more information on iSeries system parameters, see the Communications Configuration  book.

For steps on how to create a line description, see “Create a line description” on page 6.

Match iSeries system controller description parameters for a remote iSeries system

You must coordinate communications configuration parameters between local and remote iSeries systems. The parameters are described in the following table. This table shows those prompts and parameters that must be coordinated when you specify controller descriptions for the local and remote iSeries systems.

To configure a local iSeries server to a remote iSeries server:

- See “Connect one iSeries server to another iSeries server” on page 36 for an example of connecting one iSeries server to another iSeries server.
- Use the following table for the controller descriptions.

iSeries Prompt	iSeries Parameter	Remote iSeries Parameter	Notes
local area network (LAN) remote adapter address	ADPTADR	ADPTADR	The adapter address specified on the local system controller description must match the line description ADPTADR parameter specified by the remote system. If the iSeries system uses an Ethernet line through an 8209 LAN Bridge, see “Appendix C: Local Area Network Addressing Considerations” in the Communications Configuration  book.
Connection number	CNNNBR	NETADR	For X.25 switched virtual circuits (SVCs), the CNNNBR parameter on the local system controller description must match the NETADR parameter on the line description for the remote system.
Connection password	CNNPWD	CNNPWD	For switched virtual circuits (SVCs), passwords specified for each system must match.
Destination service access point	DSAP	SSAP	DSAP specified for the local iSeries server must match the SSAP specified in the remote iSeries controller description.
Exchange identifier	EXCHID	EXCHID	If used, the local iSeries controller description EXCHID must match the remote iSeries line description EXCHID. The first three digits of the exchange identifier, known as the block number, is 056 for the iSeries line. You can use the WRKLIND command to determine this value.
Initial connection	INLCNN	INLCNN	Values specified for each system must be coordinated; INLCNN(*ANS) must not be specified for both systems.
Link protocol	LINKPCL	LINKPCL	For X.25 connections, values specified for each system must match; both must be *QLLC or *ELLC.
Remote control point name	RMTCPNAME	LCLCPNAME	RMTCPNAME specified on the local iSeries system controller description must match the local control point name specified in the network attributes of the remote iSeries system.
Remote network identifier	RMTNETID	LCLNETID	RMTNETID specified on the local iSeries server controller description must match the local network ID specified in the network attributes of the remote iSeries server.

iSeries Prompt	iSeries Parameter	Remote iSeries Parameter	Notes
Data link role	ROLE	ROLE	The value specified for the local iSeries controller description ROLE parameter must match the remote iSeries line description ROLE value.
X.25 reverse charging	RVSCRG	RVSCRG	Values specified for each system must be coordinated.
Switched network backup	SNBU	SNBU	Values specified for each system must match.
Source service access point	SSAP	DSAP	SSAP specified for the local iSeries system must match the DSAP specified in the remote iSeries controller description.
Station address	STNADR	STNADR	Values specified for each system must match, unless both controller descriptions specify ROLE(*NEG).
<p>Note: For asynchronous controllers (CRTCTLASC command), if the remote system controller description specifies RMTVFY(*YES), the local system controller description must specify a local identifier (LCLID parameter) and local location name (LCLLOCNAME parameter). The remote system must also create a configuration list with the LCLID and LCLLOCNAME values from the local system controller description.</p>			

For more information on iSeries system parameters, see the Communications Configuration  book.

Match iSeries system device description parameters for a remote iSeries system

You must coordinate communications configuration parameters between local and remote iSeries systems. The parameters are described in the following table. This table shows those prompts and parameters that must be coordinated when you specify device descriptions for the local and remote iSeries systems.

To configure a local iSeries server to a remote iSeries server:

- See “Connect one iSeries server to another iSeries server” on page 36 for an example of connecting one iSeries server to another iSeries server.
- Use the following table for the device description.

iSeries Prompt	iSeries Parameter	Remote iSeries Parameter	Notes
	LCLLOCNAME	RMTLOCNAME	<p>For systems not using APPN (APPN(*NO) specified for the controller and device descriptions), this value must match the value specified by the RMTLOCNAME parameter on the remote system device description.</p> <p>APPC device descriptions are automatically created as needed by the iSeries server APPN support, when the following is specified on the controller description:</p> <ul style="list-style-type: none"> • APPN(*YES) • AUTOCRTDEV(*ALL)
Location Password	LOCPWD	LOCPWD	<p>This parameter must match on both the local and remote APPC device.</p> <p>Note: If you want a value other than *NONE for APPN devices, this value must be configured on the QAPPNRMT configuration list.</p>

iSeries Prompt	iSeries Parameter	Remote iSeries Parameter	Notes
Mode	MODE	MODE	For systems not using APPN (APPN(*NO) specified for the controller and device descriptions), this value must match the value specified by the MODE parameter on the remote device description. For systems using APPN (APPN(*YES) specified for the controller and device descriptions), the specified mode description must exist on the remote system. The mode description name need not be specified in the remote device description.
Remote location name	RMTLOCNAME	LCLLOCNAME	For systems not using APPN (APPN(*NO) specified for the controller and device descriptions), this value must match the value specified by the LCLLOCNAME parameter on the remote device description. APPC device descriptions are automatically created as needed by iSeries APPN support if APPN(*YES) is specified for the controller description.
	RMTNETID	LCLNETID	RMTNETID specified on the local iSeries server device description must match the local network ID specified in the network attributes of the remote iSeries server.
Single session	SNGSSN	SNGSSN	For Element 1 (single-session device description), this parameter must match on both the local and remote APPC device. For Element 2 (number of single-session conversations), this parameter does not need to match the remote device. Note: If you want a value other than *NO for APPN devices, this value must be configured on the QAPPNRMT configuration list.

For more information on iSeries system parameters, see the Communications Configuration  book.

Connect one iSeries server to another iSeries server

Configuration parameters must be coordinated when you specify controller, device, and line descriptions for the local and remote iSeries server.

Example: iSeries server to iSeries server using X.25

The following figure shows the matching parameters between an iSeries server connecting to another iSeries server that uses X.25.

Read a description of this figure at “Example details: iSeries server to iSeries server connection using X.25” on page 83.

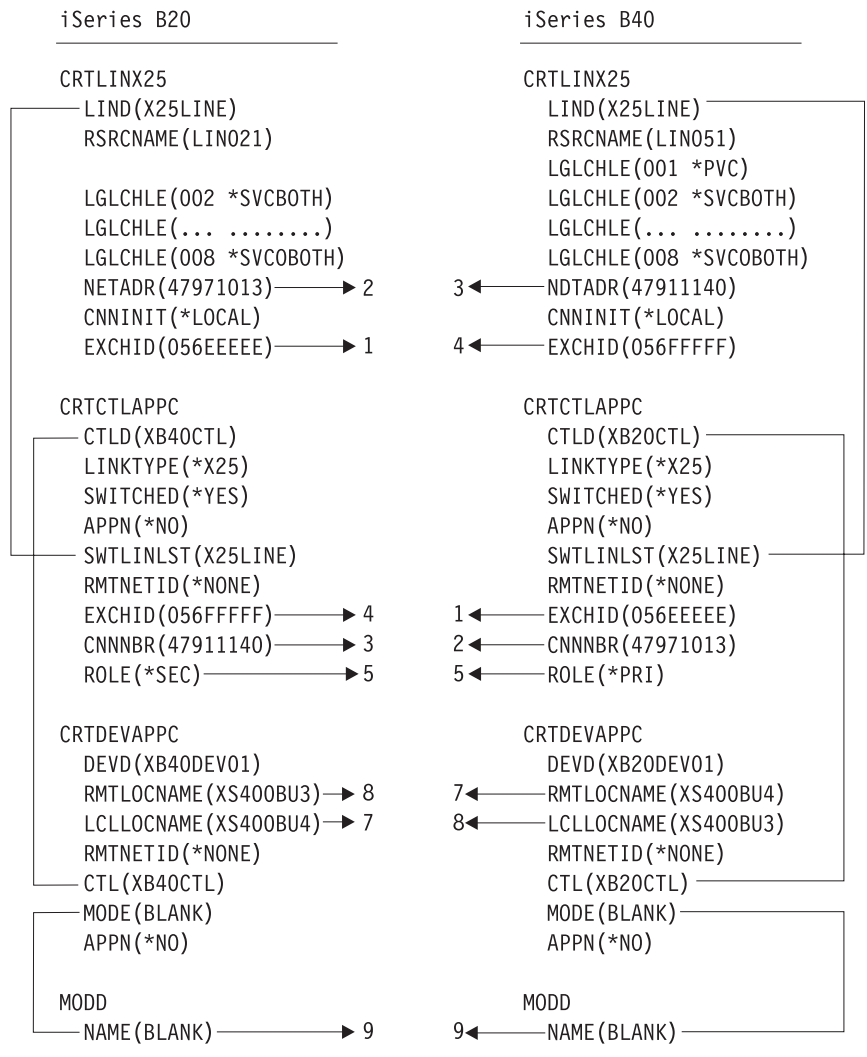

RV4T208-1

Figure 5. Figure showing how configuration parameters are related and configured. Follow the above link to detailed description for more information.

Example: iSeries server to iSeries server using SDLC

The following figure shows the matching parameters between an iSeries server connecting to another iSeries server that uses SDLC.

Read a description of this figure at “Example details: iSeries server to iSeries server connection using SDLC” on page 84.

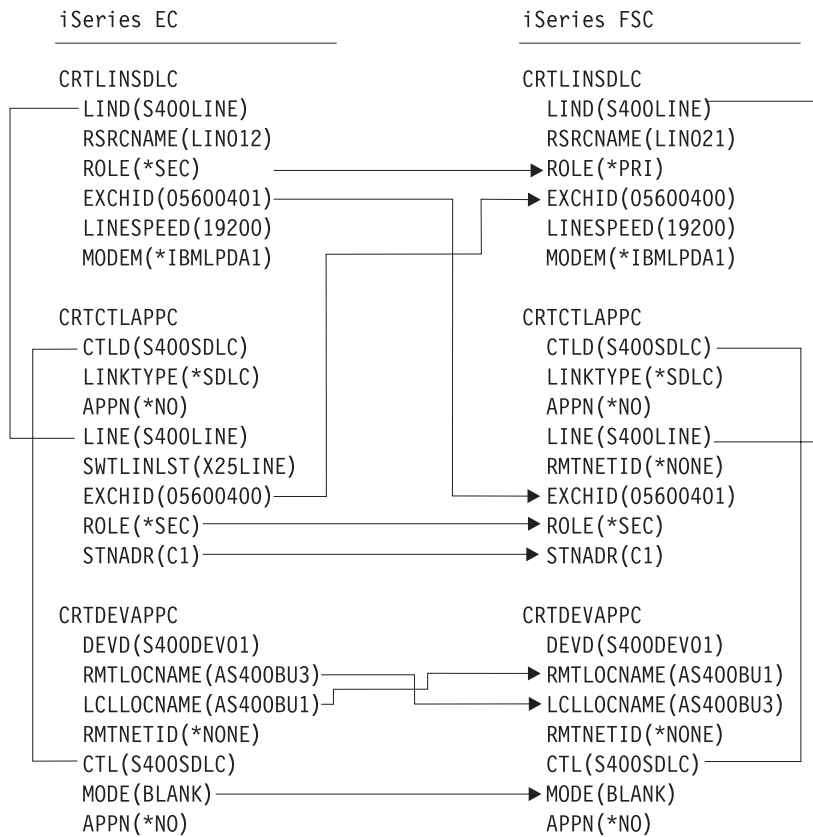

RV4T209-2

Figure 6. Figure showing how configuration parameters are related and configured. Follow the above link to detailed description for more information.

Example: iSeries server to iSeries server using one-way automatic dialing

The following figure shows the matching parameters between an iSeries server connecting to another iSeries server that uses one-way automatic-dial function.

Read a description of this figure at “Example details: iSeries server to iSeries server connection using one-way automatic dialing” on page 85.

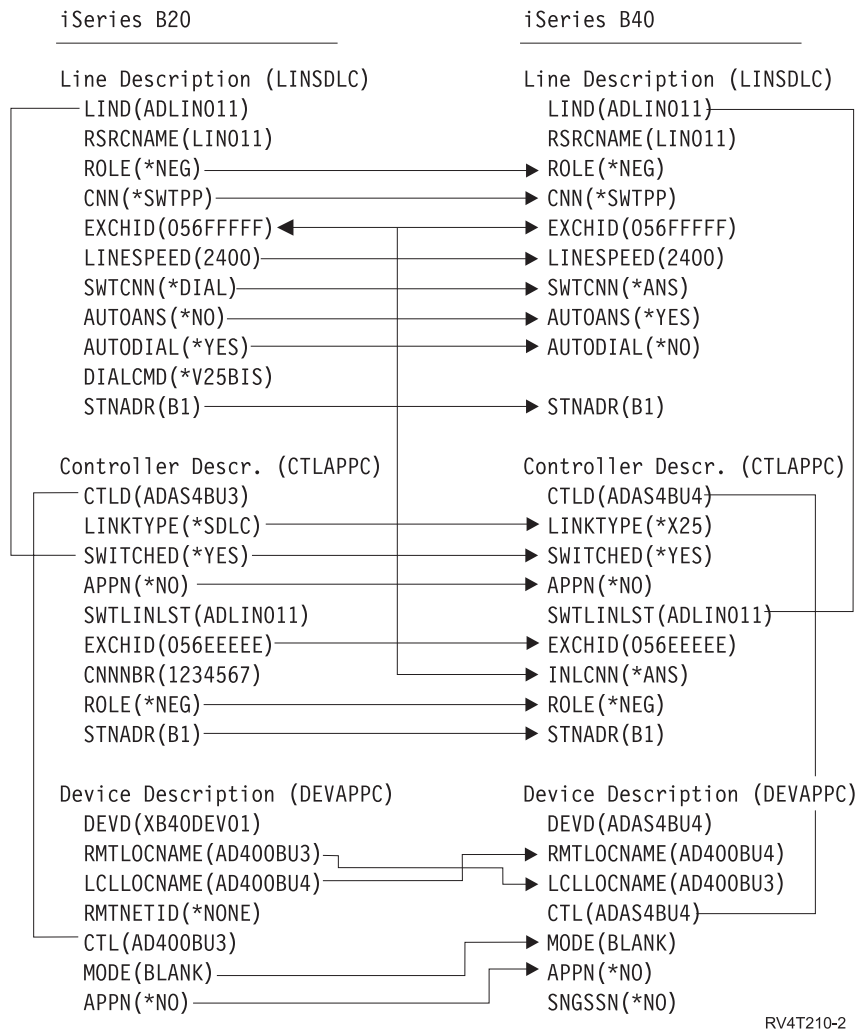

RV4T210-2

Figure 7. Figure showing how configuration parameters are related and configured. Follow the above link to detailed description for more information.

Example: iSeries server to iSeries server using Enterprise Extender (HPRIP)

The following figure shows the matching parameters between an iSeries server connecting to another iSeries server that uses Enterprise Extender.

Read a description of this figure at “Example details: iSeries server to iSeries server connection using Enterprise Extender (HPRIP)” on page 87.

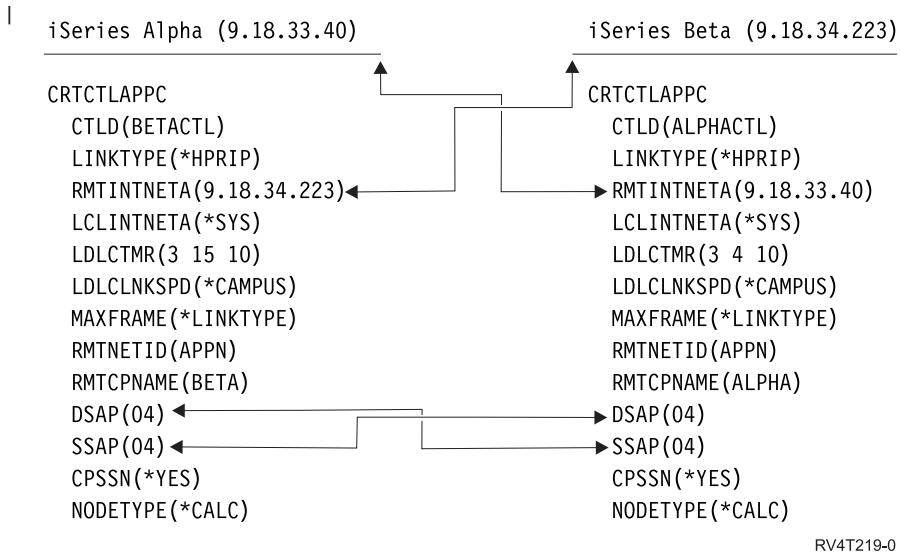

Figure 8. Figure showing how configuration parameters are related and configured. Follow the above link to detailed description for more information.

Communicate with remote workstation controllers

You can configure the iSeries system to communicate with another iSeries system, a non-iSeries system, or a remote controller. This configuration requires the coordination of configuration parameters and values.

To configure your iSeries server to communicate with remote workstation controllers, see the following:

- “Match iSeries system parameters for 5494 controllers”
- “Match iSeries system parameters for 3x74 controller” on page 48
- “Match iSeries system parameters for finance controllers” on page 53
- “Match iSeries system parameters for retail controllers” on page 58

Match iSeries system parameters for 5494 controllers

You must coordinate the configuration parameters and values to configure the iSeries system to communicate with a 5494 controller. You can coordinate these values automatically or manually. Pick one of the ways:

- To automatically connect the iSeries server to a 5494 controller, you can use the automatic remote controller (QAUTORMT) system value.
- To manually connect the iSeries server to a 5494, you can use the following tables.

The list contains only those configuration prompts and parameters that require coordination on both iSeries server and the 5494 controller. In addition, some of the parameters that are listed may not apply to your particular configuration.

- “Match iSeries system parameters for a 5494 connected by token-ring” on page 41
- “Match iSeries system parameters for a 5494 connected by Ethernet” on page 42
- “Match iSeries system parameters for a 5494 connected by frame relay” on page 43
- “Match iSeries system parameters for a 5494 connected by SDLC” on page 44
- “Match iSeries system parameters for a 5494 connected by X.21” on page 46
- “Match iSeries system parameters for a 5494 connected by X.25” on page 47

For more information about configuring the 5494, see these books:

- *IBM 5494 Remote Control Unit Planning Guide, GA27-3936*
- *IBM 5494 Remote Control Unit User’s Guide, GA27-3852*

- Remote Work Station Support  .

Match iSeries system parameters for a 5494 connected by token-ring

You must coordinate communications configuration parameters between the iSeries server and the 5494 controller that is connected by token-ring. You can coordinate these values automatically or manually.

Pick one of these ways:

- To automatically connect the iSeries server to a 5494 controller, you can use the automatic remote controller (QAUTORMT) system value.
- To manually connect the iSeries server to a 5494, use the following table. The table gives a description of the parameters. The related fields and subfields from the 5494 configuration display, the iSeries configuration value, and the matching 5494 value to enter are shown.

For more information about configuring the 5494, see these books:

- *IBM 5494 Remote Control Unit Planning Guide, GA27-3936,*
- *IBM 5494 Remote Control Unit User's Guide, GA27-3852*

iSeries Prompt	iSeries Parameter	5494 Field	5494 Subfield	iSeries Value	5494 Value	Notes
Local adapter address	ADPTADR	H1	5	-	-	Values specified in the iSeries line description (CRTLINTRN command) and for the 5494 Remote Controller Unit must match.
local area network (LAN) remote adapter address	ADPTADR	15	-	-	-	Values specified for the iSeries CRTCTLAPPC command and for the 5494 Remote Control Unit must match.
Destination service access point	(DSAP)	F	-	-	-	Values specified for the iSeries CRTCTLAPPC command and for the 5494 Remote Control Unit must match.
Local location name	LCLLOCNAME	H1	1	-	-	Values specified for the iSeries CRTCLRWS command and for the 5494 Remote Control Unit must match. .
Remote control point name	RMTCPNAME	13	-	-	-	Values specified for the iSeries CRTCTLAPPC command and for the 5494 Remote Control Unit must match.
Remote network identifier	RMTNETID	11	3	-	-	Values specified for the iSeries CRTCTLAPPC and CRTCLRWS commands and for the 5494 Remote Control Unit must match.
Remote location name	RMTLOCNAME	12	-	-	-	Values specified for the iSeries CRTCLRWS command and for the 5494 Remote Control Unit must match.

iSeries Prompt	iSeries Parameter	5494 Field	5494 Subfield	iSeries Value	5494 Value	Notes
Link type	LINKTYPE	AA	-	*LAN	4	5494 configuration values must match the values specified for the LINKTYPE parameter on the CRTCTLAPPC command. For advanced program-to-program communications (APPC) controllers that specify LINKTYPE(*SDLC), the value specified in the 5494 configuration must be compatible with the physical interface (INTERFACE parameter) specified on the CRTLINS DLC command. Select 4 for the network connections.

Match iSeries system parameters for a 5494 connected by Ethernet

You must coordinate communications configuration parameters between an iSeries system and the 5494 controller that is connected by Ethernet. A description of these parameters are in the following table. Then the related fields and subfields from the 5494 configuration display, and the iSeries configuration value and the matching 5494 value entered in the display subfield. You can coordinate these values manually or automatically. Pick one of these ways:

- To automatically connect the iSeries system to a 5494 controller, you can use the automatic remote controller (QAUTORMT) system value.
- To manually connect the iSeries server to a 5494 controller, use the following table.

For more information about configuring the 5494, see these books:

- *IBM 5494 Remote Control Unit Planning Guide, GA27-3936*
- *IBM 5494 Remote Control Unit User's Guide, GA27-3852*

iSeries Prompt	iSeries Parameter	5494 Field	5494 Subfield	iSeries Value	5494 Value	Notes
Local adapter address	ADPTADR	H1	5	-	-	Values specified in the iSeries line description (CRTLINTRN command) and for the 5494 Remote Control Unit must match.
LAN remote adapter address	ADPTADR	15	-	-	-	Values specified for the iSeries CRTCTLAPPC command and for the 5494 Remote Control Unit must match.
Local location name	LCLLOCNAME	H1	1	-	-	Values specified for the iSeries CRTCLRWS command and for the 5494 Remote Control Unit must match.
Remote control point name	RMTCPNAME	13	-	-	-	Values specified for the iSeries CRTCTLAPPC command and for the 5494 Remote Control Unit must match.

iSeries Prompt	iSeries Parameter	5494 Field	5494 Subfield	iSeries Value	5494 Value	Notes
Remote network identifier	RMTNETID	11	3	-	-	Values specified for the iSeries CRTCTLAPPC and CRTCLRWS commands and for the 5494 Remote Control Unit must match.
Remote location name	RMTLOCNAME	12	-	-	-	Values specified for the iSeries CRTCLRWS command and for the 5494 Remote Control Unit must match.

Match iSeries system parameters for a 5494 connected by frame relay

You must coordinate the communications configuration parameters between the iSeries server and the 5494 controller connected by frame relay. A description of the parameters are in the following table. Then, related fields and subfields from the 5494 configuration display and the iSeries configuration value and the matching 5494 value. You can coordinate these values automatically or manually. Pick one of these ways:

- To automatically connect the iSeries server to a 5494 controller, you can use the automatic remote controller (QAUTORMT) system value.
- To manually configure the iSeries server to a 5494 controller, use the following table.

For more information about configuring the 5494, see these books:

- *IBM 5494 Remote Control Unit Planning Guide, GA27-3936*
- *IBM 5494 Remote Control Unit User's Guide, GA27-3852*

iSeries Prompt	iSeries Parameter	5494 Field	5494 Subfield	iSeries Value	5494 Value	Notes
Local adapter address	ADPTADR	H1	5	-	-	Values specified in the iSeries line description (CRTLINTRN command) and for the 5494 Remote Controller Unit must match.
LAN remote adapter address	ADPTADR	15	-	-	-	Values specified for the iSeries CRTCTLAPPC command and for the 5494 Remote Control Unit must match.
Local location name	LCLLOCNAME	H1	1	-	-	Values specified for the iSeries CRTCLRWS command and for the 5494 Remote Control Unit must match.

iSeries Prompt	iSeries Parameter	5494 Field	5494 Subfield	iSeries Value	5494 Value	Notes
Link type	LINKTYPE	AA	-	*LAN	4	5494 configuration values must match the values specified for the LINKTYPE parameter on the CRTCTLAPPC command. For APCC controllers that specify LINKTYPE(*SDLC), the value specified in the 5494 configuration must be compatible with the physical interface (INTERFACE parameter) specified on the CRTLINS DLC command. Select 4 for the network connections.
Remote control point name	RMTCPNAME	13	-	-	-	Values specified for the iSeries CRTCTLAPPC command and for the 5494 Remote Control Unit must match.
Remote network identifier	RMTNETID	11	3	-	-	Values specified for the iSeries CRTCTLAPPC and CRTCLRWS commands and for the 5494 Remote Control Unit must match.
Remote location name	RMTLOCNAME	12	-	-	-	Values specified for the iSeries CRTCLRWS command and for the 5494 Remote Control Unit must match.

Match iSeries system parameters for a 5494 connected by SDLC

You must coordinate communications configuration parameters between the iSeries system and the 5494 controller that is connected by SDLC. These parameters are described in the following table. Then the related fields and subfields from the 5494 configuration display are listed next. These values are followed by the iSeries configuration value and the matching 5494 value to be entered in the display subfield. You can coordinate these values automatically or manually. Pick one of these ways:

- To automatically connect the iSeries server to a 5494 controller, you can use the automatic remote controller (QAUTORMT) system value.
- To manually connect the iSeries server to a 5494 controller, use the following table.

For more information about configuring the 5494, see these books:

- *IBM 5494 Remote Control Unit Planning Guide, GA27-3936*
- *IBM 5494 Remote Control Unit User's Guide, GA27-3852*

iSeries Prompt	iSeries Parameter	5494 Field	5494 Subfield	iSeries Value	5494 Value	Notes
Connection type	CNN	3	1	*NONSWTPP *MP	0	
				*SWTPP	1	
		3	*MP	0		
			*NONSWTPP *SWTPP	1		
Duplex	Duplex	3	2	*HALF	0	
				*FULL	1	
NRZI data encoding	NRZI	3	4	*YES	0	
				*NO	1	
Local location name	LCLLOCNAME	H1	1	-	-	Values specified for the iSeries CRTCLRWS command and for the 5494 Remote Control Unit must match.
Link type	LINKTYPE	AA	-	*SDLC	0,2,3	5494 configuration values must match the values specified for the LINKTYPE parameter on the CRTCLAPPC command. For APPC controllers that specify LINKTYPE(*SDLC), the value specified in the 5494 configuration must be compatible with the physical interface (INTERFACE parameter) specified on the CRTLINS DLC command. Select 0 for communications using SDLC lines other than X.21 connections.
Remote control point name	RMTCPNAME	13	-	-	-	Values specified for the iSeries CRTCLAPPC command and for the 5494 Remote Control Unit must match.
Remote network identifier	RMTNETID	11	3	-	-	Values specified for the iSeries CRTCLAPPC and CRTCLRWS commands and for the 5494 Remote Control Unit must match.
Remote location name	RMTLOCNAME	12	-	-	-	Values specified for the iSeries CRTCLRWS command and for the 5494 Remote Control Unit must match.

iSeries Prompt	iSeries Parameter	5494 Field	5494 Subfield	iSeries Value	5494 Value	Notes
Station address	STNADR	2	-	-	-	Values specified in the iSeries controller description and for the 5494 Remote Control Unit must match. This value must also be specified as the last 2 digits of the iSeries EXCHID parameter.

Match iSeries system parameters for a 5494 connected by X.21

You must coordinate communications configuration parameters between the iSeries server and the 5494 remote controller that is connected by X.21. These parameters are described in the following table. Then the related fields and subfields from the 5494 configuration display are listed next. These values are followed by the iSeries configuration value and the matching 5494 value to be entered in the display subfield. You can coordinate these values automatically or manually. Pick one of these ways:

- To automatically connect the iSeries server to a 5494 controller, you can use the automatic remote controller (QAUTORMT) system value.
- To manually connect the iSeries server to a 5494 controller, use the following table.

For more information about configuring the 5494, see these books:

- *IBM 5494 Remote Control Unit Planning Guide, GA27-3936*
- *IBM 5494 Remote Control Unit User's Guide, GA27-3852,*

iSeries Prompt	iSeries Parameter	5494 Field	5494 Subfield	iSeries Value	5494 Value	Notes
Connection number	CNNNBR	15	-	-	-	Values specified for the iSeries CRTCTLAPPC command and for the 5494 Remote Control Unit must match. If the iSeries CRTCTLAPPC command specifies CNNNBR(*DC), the X.21 direct-call user facility must be used to make the connection.
Local location name	LCLLOCNAME	H1	1	-	-	Values specified for the iSeries CRTCLRWS command and for the 5494 Remote Control Unit must match.
Remote control point name	RMTCPNAME	13	-	-	-	Values specified for the iSeries CRTCTLAPPC command and for the 5494 Remote Control Unit must match.
Remote network identifier	RMTNETID	11	3	-	-	Values specified for the iSeries CRTCTLAPPC and CRTCLRWS commands and for the 5494 Remote Control Unit must match.
Remote location name	RMTLOCNAME	12	-	-	-	Values specified for the iSeries CRTCLRWS command and for the 5494 Remote Control Unit must match.

iSeries Prompt	iSeries Parameter	5494 Field	5494 Subfield	iSeries Value	5494 Value	Notes
Link type	LINKTYPE	AA	-	*X21	4	5494 configuration values must match the values specified for the LINKTYPE parameter on the CRTCTLAPPC command. Select 2 for X.21 network connections.
Station address	STNADR	2	-	-	-	Values specified in the iSeries controller description and for the 5494 Remote Control Unit must match. This value must also be specified as the last 2 digits of the iSeries EXCHID parameter.

Match iSeries system parameters for a 5494 connected by X.25

You must coordinate communications configuration parameters between the iSeries server and the 5494 controller that is connected by X.25. These parameters are described in the following table. Then the related fields and subfields from the 5494 configuration display are listed next. These values are followed by the iSeries configuration value and the matching 5494 value to be entered in the display subfield. You can coordinate these values automatically or manually. Pick one of these ways:

- To automatically connect the iSeries server to a 5494 controller, you can use the automatic remote controller (QAUTORMT) system value.
- To manually connect the iSeries server to a 5494 controller, use the following table.

For more information about configuring the 5494, see these books:

- *IBM 5494 Remote Control Unit Planning Guide, GA27-3936*
- *IBM 5494 Remote Control Unit User's Guide, GA27-3852*

iSeries Prompt	iSeries Parameter	5494 Field	5494 Subfield	iSeries Value	5494 Value	Notes
Default packet size	DFTPFSIZE	5	1	64	0	
				128	1	
				256	2	
				512	3	
Local location name	LCLLOCNAME	H1	1	-	-	Values specified for the iSeries CRTCLRWS command and for the 5494 Remote Control Unit must match.
X.25 link protocol	LINKPCL	6	2	*QLLC	01	
				*ELLC	10	

iSeries Prompt	iSeries Parameter	5494 Field	5494 Subfield	iSeries Value	5494 Value	Notes
Link type	LINKTYPE	AA	-	*X25	1	5494 configuration values must match the values specified for the LINKTYPE parameter on the CRTCTLAPPC command. For APPC controllers that specify LINKTYPE(*SDLC), the value specified in the 5494 configuration must be compatible with the physical interface (INTERFACE parameter) specified on the CRTLINS DLC command. Select 1 for communications using X.25 lines.
X.25 network level	NETLVL	6	5	1988	0	Used for X.25 communications only.
				1984	1	
				1980	2	
Remote control point name	RMTCPNAME	13	-	-	-	Values specified for the iSeries CRTCTLAPPC command and for the 5494 Remote Control Unit must match.
Remote network identifier	RMTNETID	11	3	-	-	Values specified for the iSeries CRTCTLAPPC and CRTCLRWS commands and for the 5494 Remote Control Unit must match.
Remote location name	RMTLOCNAME	12	-	-	-	Values specified for the iSeries CRTCLRWS command and for the 5494 Remote Control Unit must match.
Station address	STNADR	2	-	-	-	Values specified in the iSeries controller description and for the 5494 Remote Control Unit must match. This value must also be specified as the last 2 digits of the iSeries EXCHID parameter.

Match iSeries system parameters for 3x74 controller

You must match the iSeries configuration parameters with some configuration questions and sequence numbers when you configure the 3174 and 3274 controllers.

For an example of connecting an iSeries server to a 3174 remote controller, see “Example: iSeries server connection to a 3174 control unit” on page 52.

- “Match iSeries system parameters for a 3174 controller”
- “Match iSeries system parameters for a 3274 controller” on page 51

Match iSeries system parameters for a 3174 controller



You must match the iSeries configuration parameters with the configuration questions and sequence numbers to configure the 3174 controller. These parameters are described in the following table.

For more information about configuring the 3174 controllers, see these books:

- 3174 Subsystem Control Unit Customizing Guide
- 3174 Establishment Controller Supplemental Customer Information for Configuration Support C Release 4 Ethernet Attachment, GA27-3994 has information about Ethernet support.

To configure the iSeries server to a 3174 controller:

- See "Example: iSeries server connection to a 3174 control unit" on page 52 for an example of connecting an iSeries server to a 3174 remote controller.
- Use the following table to connect an iSeries server to a 3174 remote controller.

iSeries Prompt	iSeries Parameter	3174 Configuration Questions	Notes
LAN remote adapter address ¹	ADPTADR	084, 106	<p><i>Ethernet Address</i></p> <p>If the iSeries system uses an Ethernet line to connect to the 3174 controller, use table C-3 on page C-4 in "Appendix C: Local Area Network Addressing Considerations" of the Communications Configuration  book to convert the value specified for question 084. Specify the converted address for the ADPTADR parameter on the CRTCLRWS or CRTCLAPPCC command.</p> <p><i>Token-Ring Network Address of the 3174</i></p> <p>If the iSeries server uses a Token-Ring network line to connect to the 3174 controller, values specified for question 106 and for the ADPTADR parameter on the CRTCLRWS or CRTCLAPPCC command must match.</p> <p>If the iSeries server uses an Ethernet line through an 8209 LAN Bridge, see "Appendix C: Local Area Network Addressing Considerations" in the Communications Configuration book.</p>
Local adapter address	ADPTADR	107	<p><i>Token-Ring Network Address of the Gateway</i></p> <p>If the iSeries server uses a Token-Ring network line to connect to the 3174 controller, values specified for question 107 and for the ADPTADR parameter on the CRTLINTRN command must match.</p> <p>If the iSeries server uses an Ethernet line through an 8209 LAN Bridge, see "Appendix C: Local Area Network Addressing Considerations" in the the Communications Configuration  book, for information about specifying the ADPTADR parameter on the CRTLINETH command.</p>
Connection number	C>NNNBR	423	<p><i>Host DTE Address (HNAD)</i></p> <p>For X.25 lines, the numbers specified on the CRTLINX25 command and in question 423 must match.</p>
		368	<p><i>X.21 Switched Short-Hold Mode Dial Number</i></p> <p>For X.21 short-hold mode connections, the numbers specified on the CRTCLRWS command and in question 368 must match.</p>
		424	<p><i>3174 DTE Address</i></p> <p>For X.25 SVCs, the connection number specified on the CRTCLRWS command and in question 424 must match.</p>

iSeries Prompt	iSeries Parameter	3174 Configuration Questions	Notes
Destination service access point	DSAP	940	<i>Ring Address Assignment</i> The value specified for the DSAP parameter on the CRTCTLRWS command must match the SAP@ specified for the 3174 on the Ring Address Assignment display. Used for token-ring only.
Exchange identifier	EXCHID	215	<i>Physical Unit Identification</i> For switched connections, the 5-digit hexadecimal value specified for question 215 must match the last 5 digits of the exchange identifier specified on the CRTCTLRWS command.
Link type	LINKTYPE	101	<i>Host Attachment (3174)</i> Values specified on the CRTCTLRWS command and for question 101 must match as follows: <ul style="list-style-type: none"> • LINKTYPE(*SDLC), 101 = 2 • LINKTYPE(*X25), 101 = 3 • LINKTYPE(*LAN), 101 = 7 (token ring) • LINKTYPE(*LAN), 101 = 8 (Ethernet)
Modem data rate select	MODEMRATE	318	<i>Full- or Half-Speed Transmission</i> The values specified for the MODEMRATE parameter on the CRTLINS DLC and CRTLINX25 commands must match question 318 as follows: <ul style="list-style-type: none"> • If MODEMRATE(*FULL), 318 = 0 • If MODEMRATE(*HALF), 318 = 1
Local network address	NETADR	423	<i>Host DTE Address (HNAD)</i> For X.25 SVCs, the network address specified on the CRTLINX25 command and in question 423 must match.
NRZI data encoding	NRZI	313	<i>NRZ or NRZI Encoding</i> For SDLC lines only, the values specified on the CRTLINS DLC command and in question 313 must match as follows: <ul style="list-style-type: none"> • If NRZI(*NO), 313 = 0 • If NRZI(*YES), 313 = 1
Source service access point	SSAP	940	<i>Ring Address Assignment</i> The value specified for the SSAP parameter on the CRTCTLRWS command must match the SAP@ associated with the Ring@ (adapter address) of the iSeries system on the Ring Address Assignment display. Used for token-ring only.
Short-hold mode	SHM	367	<i>X.21 Switched Short-Hold Mode</i> Values specified on the CRTCTLRWS command and in question 367 match as follows: <ul style="list-style-type: none"> • If SHM(*NO), 367 = 0 • If SHM(*YES), 367 = 2

iSeries Prompt	iSeries Parameter	3174 Configuration Questions	Notes
Station address	STNADR	104	<i>Control Unit Address</i> Value specified for question 104 must match the STNADR specified on the CRTCLRWS command.
Switched connection	SWITCHED	317	<i>Telecommunication Facilities</i> Values specified on the CRTLNSDLC command and in question 317 match as follows: <ul style="list-style-type: none"> • If SWITCHED(*NO), 317 = 0 • If SWITCHED(*YES), 317 = 1
<p>Note: If you are using a 3174 Model 1L Gateway to connect an iSeries server to a host server on a Token-Ring, the value specified for item 900 (<i>Token-Ring Network Address of the Gateway</i>) must match the value specified for the ADPTADR parameter on the CRTCLHOST command.</p>			

Match iSeries system parameters for a 3274 controller

You match the iSeries configuration parameters with the configuration questions and sequence numbers to configure the 3274 controller. These parameters are described in the following table.

For more information about configuring the 3274 controller, see the *3274 Control Unit Planning, Setup, and Customizing Guide*.

To configure the iSeries server to a 3274 controller:

- See “Example: iSeries server connection to a 3174 control unit” on page 52 for an example of connecting an iSeries server to a 3174 remote controller.
- Use the following table to connect an iSeries server to a 3274 controller.

iSeries Prompt	iSeries Parameter	3274 Sequence Number	Notes
Connection number	CNNNBR	411	<i>3274 DTE Address</i> For X.25 SVCs, the connection number specified on the CRTCLRWS command and in sequence number 411 must match.
Exchange identifier	EXCHID	215	<i>Physical Unit Identification</i> For switched connections, the 5-digit hexadecimal value specified for sequence number 215 must match the last 5 digits of the exchange identifier specified on the CRTCLRWS command.
X.25 link protocol	LINKPCL	403	<i>Logical Link Control</i> For X.25 connections, values specified must match. Specify LINKPCL(*QLLC) on the CRTCLRWS command; specify 1 (QLLC) for sequence number 403.
Link type	LINKTYPE	331	<i>BSC/SDLC/X.25 Protocol</i> Values specified on the CRTCLRWS command and in sequence number 331 must match as follows: <ul style="list-style-type: none"> • If LINKTYPE(*SDLC), 331 = 1 • If LINKTYPE(*X25), 331 = 2

iSeries Prompt	iSeries Parameter	3274 Sequence Number	Notes
Local network address	NETADR	410	<i>Host DTE Address (HNAD)</i> For X.25 SVCs, the network address specified on the CRTLINX25 command and in sequence number 410 must match.
Modem data rate select	MODEMRATE	318	<i>Full- or Half-Speed Transmission</i> The values specified for the MODEMRATE parameter on the CRTLINS DLC and CRTLINX25 commands must match sequence number 318 as follows: <ul style="list-style-type: none"> • If MODEMRATE(*FULL), 318 = 0 • If MODEMRATE(*HALF), 318 = 1
NRZI data encoding	NRZI	313	<i>NRZ or NRZI Encoding</i> For SDLC lines only, the values specified must match as follows: <ul style="list-style-type: none"> • If NRZI(*NO), 313 = 0 • If NRZI(*YES), 313 = 1
Short-hold mode	SHM	362	<i>X.21 Switched Options</i> If SHM(*YES) is specified on the CRTCTLRWS command, digit 7 or 8 of question 362 must be set to 1. (For example, xxxxxx10 indicates that the DCE is supported for direct calls.)
Station address	STNADR	302	<i>Control Unit Address</i> Value specified for item 302 must match that specified on the CRTCTLRWS command.

Example: iSeries server connection to a 3174 control unit: Configuration parameters must be coordinated when you connect an iSeries server to a 3174 controller.

Read a description of this figure at “Example details: iSeries server connection to a 3174 control unit” on page 88.

The following figure shows the iSeries system parameters and 3174 parameters that need to match when you use token-ring.

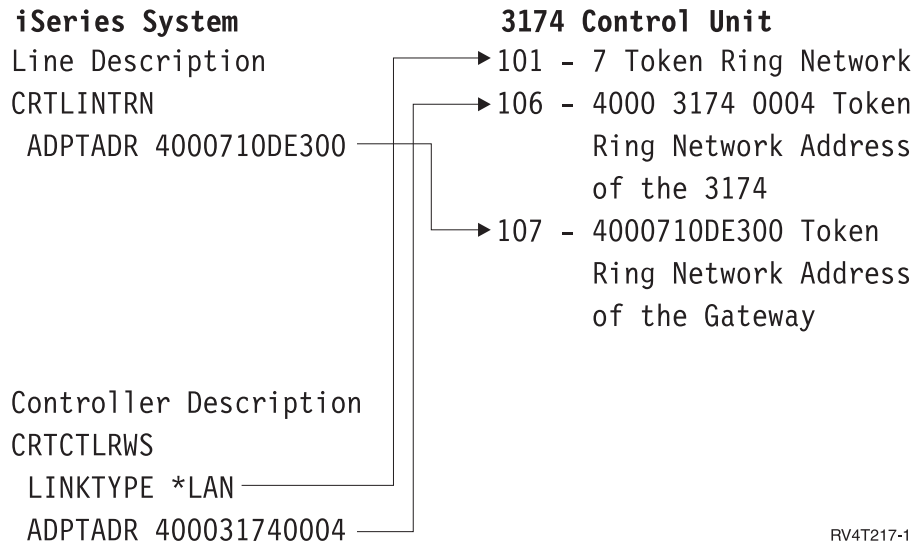

Figure 9. Figure showing the iSeries system parameters and 3174 parameters that need to match when you use token-ring

Match iSeries system parameters for finance controllers

You must coordinate several parameter values that are specified for the iSeries system and in the controller configuration for finance communications.

For an example of connecting an iSeries server to a 4701 finance controller, see “Example: iSeries server connection to a finance network” on page 58.

- “Match iSeries system parameters for 470x finance controllers”
- “Match iSeries system parameters for FBSS finance controllers” on page 55

Match iSeries system parameters for 470x finance controllers

You must match the iSeries configuration parameters with the configuration (CPGEN) for the 4701 and 4702 finance controllers. These parameters are described in the following table.

iSeries prompts are listed in alphabetical order by parameter name; the iSeries commands on which the parameters are specified are included in the rightmost column of the table.

For more information about configuring the 4700 controllers, see Volume 6 of the *4700 Finance Communication System Controller Programming Library*, GC31-2068.

To configure the iSeries server to a 470x finance controller:

- See “Example: iSeries server connection to a finance network” on page 58 for an example of connecting an iSeries server to a 4701 finance controller.
- Use the following table to connect an iSeries server to a 4701 finance controller.

iSeries Prompt	iSeries Parameter	4700 Macro	4700 Parameter
Connection type	CNN	COMLINK	ACB For SDLC finance communications, if the line is switched (CNN(*SWTPP) on the CRTLINSDLC command or SWITCHED(*YES) on the CRTCTLFNC command), include the SWM value on the ACB parameter (ACB = SWM).

iSeries Prompt	iSeries Parameter	4700 Macro	4700 Parameter
Exchange identifier	EXCHID	X25CKT	<p>XID</p> <p>The values specified for the 4700 and the iSeries system must match. The block number for the 4700 (first 3 digits of the iSeries EXCHID parameter) must be 057.</p> <p>The 4700 parameter values are decimal numbers; the iSeries values are hexadecimal.</p>
X.25 link protocol	LINKPCL	X25CKT	<p>LLC</p> <p>For X.25 finance communications, the LLC parameter must specify QLLC for the type of logical link control. LINKPCL(*QLLC) must also be specified on the iSeries CRTCTLFNC command.</p>
Link type	LINKTYPE	COMLINK	<p>TYPE</p> <p>4700 TYPE parameter must match the LINKTYPE parameter specified on the iSeries CRTCTLFNC command.</p> <ul style="list-style-type: none"> • If LINKTYPE(*SDLC), specify TYPE = 4502. • If LINKTYPE(*X25), specify TYPE = 1424.
Local location address	LOCADR	STATION	<p>ID</p> <p>If the optional LUA parameter is not specified, the value specified for the 4700 ID parameter must match the value specified for the LOCADR parameter on the CRTDEVFNC command. If LUA is specified, the LUA parameter value must match the LOCADR parameter.</p> <p>The 4700 parameter values are decimal numbers; the iSeries values are hexadecimal.</p>
Maximum frame size	MAXFRAME	COMLINK	<p>CNL</p> <p>Value specified for the 4700 CNL parameter must be coordinated with the value specified for the iSeries MAXFRAME parameter on the CRTCTLFNC command. Because the MAXFRAME parameter includes transmission and request header lengths, MAXFRAME should be 9 bytes longer than the 4700 CNL parameter.</p>
			<p>MWL</p> <p>Value specified for the 4700 MWL parameter must be coordinated with the value specified for the iSeries MAXFRAME parameter on the CRTCTLFNC command. Because the MAXFRAME parameter includes transmission and request header lengths, MAXFRAME should be 9 bytes longer than the 4700 MWL parameter.</p> <p>If the iSeries maximum length of request unit (MAXLENRU parameter) specified for device descriptions attached to the 4700 controller is larger than the MAXFRAME parameter specified for the controller description, the 4700 should also specify OPTIONS=(SEGMENT).</p>

iSeries Prompt	iSeries Parameter	4700 Macro	4700 Parameter
NRZI data encoding	NRZI	COMLINK	ACB For SDLC finance communications, if the line does not use NRZI data encoding (NRZI(*NO) on the CRTLINS DLC command), include the DCE value on the ACB parameter (ACB = DCE).
Station address	STNADR	X25CKT	CUA The values specified for the iSeries STNADR parameter on the CRTCTLFNC command must match the physical address (CUA) parameter specified for the 4700.

Match iSeries system parameters for FBSS finance controllers

You must coordinate several parameter values that are specified for the iSeries system and IBM Financial Branch System Services (FBSS) finance controllers in the controller configuration. The following table shows those iSeries configuration parameters that must match values on the SDLC, Token-Ring, or X.25DLC configuration displays for FBSS controllers.

iSeries prompts are listed in alphabetical order by parameter name; the iSeries commands on which the parameters are specified are included in the rightmost column of the table.

For more information about configuring FBSS controllers, see the *IBM Financial Branch System Services Installation Planning and Administration Guide*, SC19-5173.

For more information about configuring the 4700 controllers, see Volume 6 of the *4700 Finance Communication System Controller Programming Library*, GC31-2068.

To configure the iSeries server to a FBSS finance controller:

- See "Example: iSeries server connection to a finance network" on page 58 for an example of connecting an iSeries server to a 4701 finance controller.
- Use the following table to connect an iSeries server to a 4701 finance controller.

Table 1. iSeries parameters that must match values for the FBSS controllers



iSeries Prompt	iSeries Parameter	FBSS Configuration Display	FBSS Prompt
LAN adapter address	ADPTADR	Token Ring Communications	<p><i>PC address</i></p> <p>If the iSeries system uses a Token-Ring network line to connect to the FBSS controller, values specified for the FBSS and on the ADPTADR parameter on the CRTLINTRN command must match.</p> <p>If the iSeries system uses an Ethernet line through an 8209 LAN Bridge, see "Appendix C: Local Area Network Addressing Considerations" in the Communications Configuration  book.</p> <hr/> <p><i>Host/37xx/4700 address</i></p> <p>If the iSeries system uses a Token-Ring network line to connect to the FBSS controller, values specified for the FBSS and on the ADPTADR parameter on the CRTLINTRN command must match.</p> <p>If the iSeries system uses an Ethernet line through an 8209 LAN Bridge, see "Appendix C: Local Area Network Addressing Considerations" in the Communications Configuration  book.</p>
Connection type	CNN	SDLC Communications	<p><i>Switched line</i></p> <p>Values specified for the FBSS and iSeries configurations must match:</p> <ul style="list-style-type: none"> • If the FBSS response is Yes, CNN(*SWTPP) must be specified for the CRTLINS DLC command and SWITCHED(*YES) for the CRTCTLFNC command. • If the FBSS response is No, CNN(*NONSWTPP) or CNN(*MP) must be specified for the CRTLINS DLC command and SWITCHED(*NO) for the CRTCTLFNC command.
Destination service access point	DSAP	Token Ring Communications	<p><i>Service access point for PC</i></p> <p>Values specified for the FBSS and for the DSAP parameter on the CRTCTLFNC command must match.</p>
Duplex	DUPLEX	SDLC Communications	<p><i>Line mode</i></p> <p>Values specified for the FBSS and iSeries configurations must match:</p> <ul style="list-style-type: none"> • If the FBSS response is Turn. required, DUPLEX(*HALF) must be specified for the CRTLINS DLC command. • If the FBSS response is CRTS (Continuous request to send), DUPLEX(*FULL) must be specified for the CRTLINS DLC command.

Table 1. iSeries parameters that must match values for the FBSS controllers (continued)

iSeries Prompt	iSeries Parameter	FBSS Configuration Display	FBSS Prompt
Exchange identifier	EXCHID	SDLC Communications	<p><i>Identification block and Identification number</i></p> <p>The values specified for the FBSS controller must match the value specified in the EXCHID parameter of the CRTCTLFNC command. The EXCHID parameter must be specified as: xxxyyyyy, where xxx matches the FBSS <i>Identification block</i> and yyyyy matches the FBSS <i>Identification number</i>.</p>
Link type	LINKTYPE	Communication Servers	<p><i>Data Link Control</i></p> <p>Values specified for the FBSS and iSeries configurations must match:</p> <ul style="list-style-type: none"> • If the FBSS response is SDLC, LINKTYPE(*SDLC) must be specified for the CRTCTLFNC command. • If the FBSS response is TRDLC, LINKTYPE(*LAN) must be specified for the CRTCTLFNC command. • If the FBSS response is X25DLC, LINKTYPE(*X25) must be specified for the CRTCTLFNC command.
Local location address	LOCADR	Session-Id and LU Assignments	<p><i>Host Logical Unit Numbers</i></p> <p>FBSS logical unit number must match the LOCADR parameter value specified on the CRTDEVFNC command.</p> <p>The FBSS logical unit assignments are decimal numbers; the iSeries values must be hexadecimal.</p>
		LU Assignments for Display Emulators LU Assignments for 3287 Printer Emulator	<p><i>Host Logical Unit Numbers</i></p> <p>FBSS logical unit number must match the LOCADR parameter value specified on the CRTDEVDSP or CRTDEVPRT command for 3270 devices attached to the FBSS controller.</p> <p>The FBSS logical unit assignments are decimal numbers; the iSeries values must be hexadecimal.</p>
NRZI data encoding	NRZI	SDLC Communications	<p><i>N.R.Z.I.</i></p> <p>Values specified for the iSeries CRTLINS DLC command and the FBSS controller must match.</p>
Source service access point	SSAP	Token Ring Communications	<p><i>Service access point for Host/37xx/4700</i></p> <p>Values specified for the FBSS and for the SSAP parameter on the CRTCTLFNC command must match.</p>
SSCP identifier	SSCPID	SSCP Names	<p><i>SSCP namexx</i></p> <p>If used, the value specified for the FBSS controller must match the last 10 digits of the SSCPID parameter on the CRTCTLFNC command.</p>
Station address	STNADR	SDLC Communications	<p><i>Station address</i></p> <p>Values specified for the iSeries CRTCTLFNC command and the FBSS controller must match.</p>

Example: iSeries server connection to a finance network: Configuration parameters must be coordinated when you connect an iSeries server to a 4701 finance controller.

Read a description of this figure at “Example details: iSeries server connection to a finance network” on page 88.

Finance communications use high-level language operations and communications functions that allow you to communicate between an iSeries server and finance controllers.

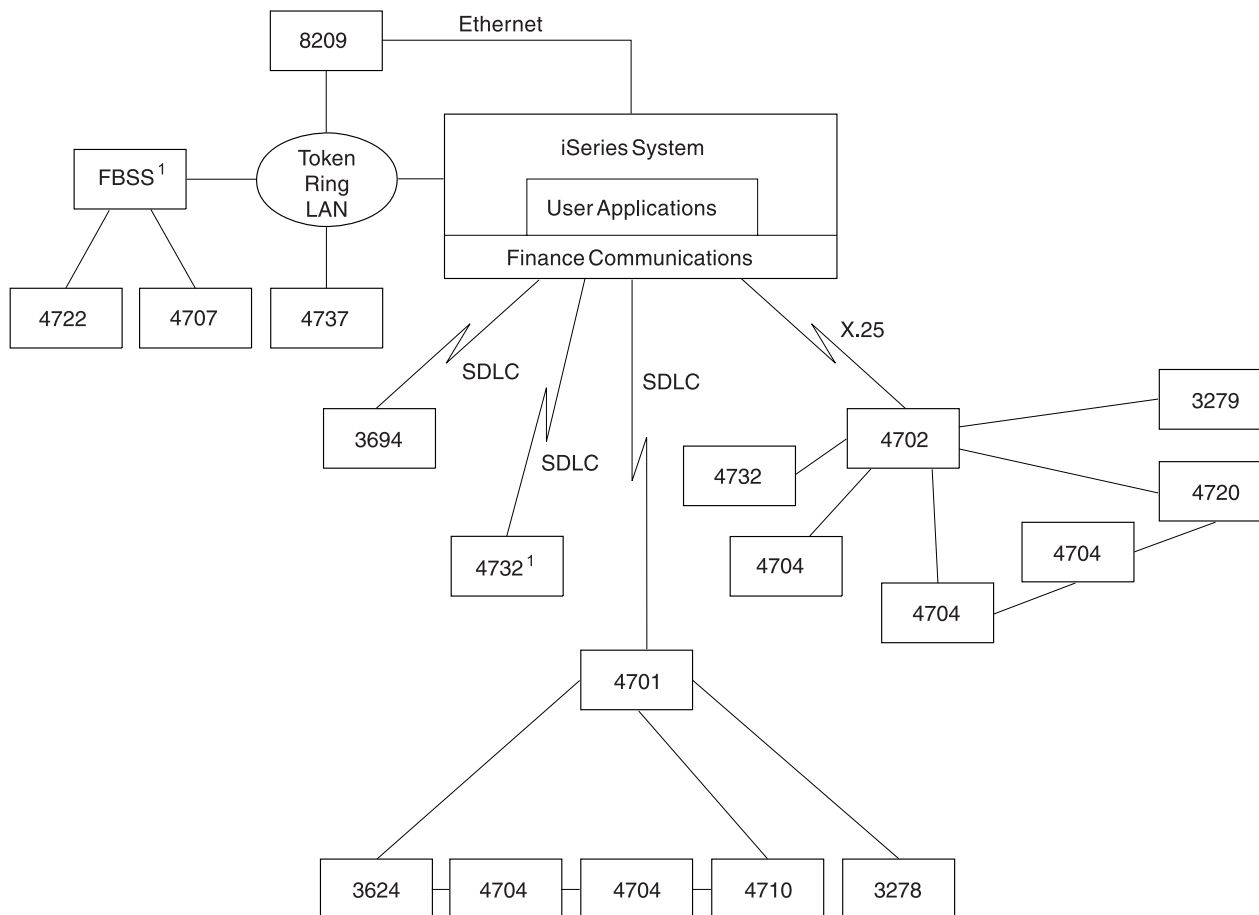

¹ ICF only

RV2P875-1

Figure 10. A figure showing the structure of communications between an iSeries server and finance controllers

Match iSeries system parameters for retail controllers

You must coordinate several iSeries system parameter values with retail controllers for retail communications. These values are specified for the iSeries server and in the controller configuration.

For an example on connecting an iSeries server to a 4690 retail controller, see “Example: iSeries server connection to a 4690 retail controller” on page 66.

To match parameters for VTAM definition statements, see the following.

- “Match iSeries system controller description parameters for a host system” on page 22
- “Match iSeries system device description parameters for a host system” on page 24
- “Match iSeries system line description parameters for a host system” on page 21

For more information about configuring the 3651 controller, see the *IBM Programmable Store System Language and Host Services: Macro Reference*, GC30-3076, book.

To configure an iSeries server to a retail controller, see the following.

- “Match iSeries system parameters for 3651 retail controllers”
- “Match iSeries system parameters for 3684 retail controllers” on page 61
- “Match iSeries system parameters for 4680/4690 LINE parameter” on page 63
- “Match iSeries system parameters for 4680/4690 LINK parameter” on page 64
- “Match iSeries system parameters for 4684 retail controllers” on page 65

Match iSeries system parameters for 3651 retail controllers

You must coordinate several parameter values for retail communications. These values are specified for the iSeries server and the 3651 retail controller. The following table lists those iSeries parameters that must match values for the 3651 retail controllers.

Before you match parameters for 3651 retail controllers, you need to match iSeries system controller, device, and line descriptions parameters with the host system.

iSeries parameters are listed in alphabetical order; the commands on which the parameters are specified are included in the rightmost column of the table.

For more information about configuring the 3651 controller, see the *IBM Programmable Store System Language and Host Services: Macro Reference*

To configure the iSeries server to a 3651 retail controller, use the following table.

iSeries Prompt	iSeries Parameter	3651 Definition Statement	3651 Parameter
Connection type	CNN	QFHOST	SDLCLIN Value specified for the iSeries CNN parameter on the CRTLINS DLC command must match the values specified for bits 2 and 3 of the 3651 SDLCLIN parameter.
Duplex	DUPLEX	QFHOST	SDLCLIN Value specified for the iSeries DUPLEX parameter on the CRTLINS DLC command must match the value specified for bit 6 of the 3651 SDLCLIN parameter.
Exchange identifier	EXCHID	QFHOST	SENDID 3651 SENDID parameter must match the last 5 digits of the EXCHID parameter specified on the iSeries CRTLINS DLC command. (This parameter is used only for switched line communications.)
			RECVID 3651 RECVID parameter must match the last 5 digits of the EXCHID parameter specified on the iSeries CRTCTLR TL command.
Modem data rate	MODEMRATE	QFHOST	SDLCLIN Value specified for the iSeries MODEMRATE parameter on the CRTLINS DLC command must match the value specified for bit 5 of the 3651 SDLCLIN parameter.

iSeries Prompt	iSeries Parameter	3651 Definition Statement	3651 Parameter
NRZI data encoding	NRZI	QFHOST	SDLCLIN Value specified for the iSeries NRZI parameter on the CRTLINS DLC command must match the value specified for bit 1 of the 3651 SDLCLIN parameter.
SSCP identifier	SSCPID	QFHOST	SSCPID 3651 SSCPID parameter must match the SSCPID parameter specified on the iSeries CRTCTLRTL command.
Station address	STNADR	QFHOST	SDLCPOL 3651 SDLCPOL parameter must match the STNADR parameter specified on the iSeries CRTCTLRTL command.
Switched connection	SWITCHED	QFHOST	SDLCLIN Value specified for the iSeries SWITCHED parameter on the CRTCTLRTL command must match the values specified for bits 2 and 3 of the 3651 SDLCLIN parameter.
<p>Note: For the iSeries server, the 3651 QFHOST definition must specify DIRATT=NO.</p> <p>The value specified for the iSeries parameters on the CRTLINS DLC command must match the values specified on the 3651 SDLCLIN parameter.</p>			

For information about the SDLCLIN parameter, see “Specify the SDLCLIN parameter for 3651 retail controllers.”

Specify the SDLCLIN parameter for 3651 retail controllers: The following table describes how to coordinate values for parameters on the iSeries CRTLINS DLC and CRTCTLRTL commands with bits that are specified for the 3651 SDLCLIN parameter.

The SDLCLIN parameter is specified as a series of 8 bits, designated 0 through 7 (01234567). The default value for the SDLCLIN parameter when used with an SDLC line is 01100001, or hex 61.

The default value for each bit is underlined in the *Bit Value* column.

To configure the iSeries server to a 3651 controller, use the following table.

SDLCLIN Bit	Bit Value	iSeries Parameter and Value	Notes
0	<u>0</u>	None	Data terminal ready. There is no equivalent parameter for the iSeries system. Specify 0 to indicate that the data terminal ready (DTR) signal is on when the controller is powered on, or 1 to indicate that the DTR is off when the controller is powered on. This bit should be set to 1 only if the configuration being defined includes IBM world trade data communications equipment (DCE) in a switched network.
	1	None	

SDLCLIN Bit	Bit Value	iSeries Parameter and Value	Notes
1	0	NRZI(*NO)	Specify 1 if the data communications equipment (DCE) provides the clocking or if NRZI data encoding is used.
	<u>1</u>	NRZI(*YES)	
2 and 3	00	SWITCHED(*YES) CNN(*SWTPP)	Bit 2: Specify 1 if using nonswitched communications, or 0 if using switched communications. If switched, the SENDID parameter must also be specified.
	01	Not valid	
	<u>10</u>	SWITCHED(*NO) and CNN(*NONSWTPP)	Bit 3: Specify 1 if using a multipoint communications protocol, or 0 if not. 01 is not a valid combination for these bits.
	11	SWITCHED(*NO) and CNN(*MP)	
4	<u>0</u>	None (See Notes)	Direct attachment. This bit must be set to 0 for communications with the iSeries system. There is no equivalent parameter for the iSeries system.
	1	None	
5	<u>0</u>	MODEMRATE(*FULL)	Modem data rate.
	1	MODEMRATE(*HALF)	
6	<u>0</u>	DUPLEX(*HALF)	Data carrier setting.
	1	DUPLEX(*FULL)	
7	0	None	Answer tone generation. There is no equivalent parameter for the iSeries system. Specify 0 to indicate that the modem generates the answer tone, or 1 to indicate that the controller generates the answer tone.
	<u>1</u>	None	

For information about SDLC, see “Synchronous data link control network” on page 71.

Match iSeries system parameters for 3684 retail controllers

You must coordinate parameters with the iSeries system and the 3684 retail controller. The following table lists those parameters.

iSeries parameters are listed in alphabetical order; the commands on which the parameters are specified are included in the rightmost column of the table.

To configure the iSeries server to a 3684 controller, use the following table.

iSeries Prompt	iSeries Parameter	3684 Definition Statement	3684 Parameter
Connection type	CNN	QFSFGLNK	LINECON Value specified for the iSeries CNN parameter on the CRTLINS DLC command must match the values specified for bits 2 and 3 of the 3684 LINECON parameter.
Duplex	DUPLEX	QFSFGLNK	LINECON Value specified for the iSeries DUPLEX parameter on the CRTLINS DLC command must match the value specified for bit 6 of the 3684 LINECON parameter.

iSeries Prompt	iSeries Parameter	3684 Definition Statement	3684 Parameter
Exchange identifier	EXCHID	QVSFGLNK	SENDID 3684 SENDID parameter must match the last 5 digits of the EXCHID parameter specified on the iSeries CRTCLRRTL command.
			RECVID 3684 RECVID parameter must match the last 5 digits of the EXCHID parameter specified on the iSeries CRTLNSDLC command. (This parameter is used only for switched line communications.)
Modem data rate	MODEMRATE	QFSFGLNK	LINECON Value specified for the iSeries MODEMRATE parameter on the CRTLNSDLC command must match the value specified for bit 5 of the 3684 LINECON parameter.
NRZI data encoding	NRZI	QFSFGLNK	LINECON Value specified for the iSeries NRZI parameter on the CRTLNSDLC command must match the value specified for bit 1 of the 3684 LINECON parameter.
Switched network backup	SNBU	QFSFGLNK	LINECON Value specified for the iSeries SNBU parameter on the CRTLNSDLC command must match the value specified for bit 4 of the 3684 LINECON parameter.
SSCP identifier	SSCPID	QVSFGLNK	SSCPID 3684 SSCPID parameter must match the SSCPID parameter specified on the iSeries CRTCLRRTL command.
Station address	STNADR	QVSFGLNK	POLCHAR 3684 POLCHAR parameter must match the 2-digit hexadecimal address specified for the STNADR parameter on the iSeries CRTCLRRTL command. Allowed values are in the range 01 through FE.
Switched connection	SWITCHED	QFSFGLNK	LINECON Value specified for the iSeries SWITCHED parameter on the CRTCLRRTL command must match the values specified for bits 2 and 3 of the 3684 LINECON parameter.
<p>Note: For the iSeries server, the 3684 QVSFGLNK, QVSFCOMM, and QVSFSESN definitions must each specify DATA LNK=SDLC.</p> <p>Values specified for the iSeries parameters on the CRTCLRRTL and CRTLNSDLC commands must match the values specified on the 3684 LINECON parameter.</p>			

For information about the LINECON parameter, see “Specify the LINECON parameter for 3684 retail controllers.”

Specify the LINECON parameter for 3684 retail controllers: The following table describes how to coordinate values that are specified for parameters on the iSeries LINECON parameter.

The LINECON parameter is specified as a series of 8 bits, designated 0 through 7 (01234567). The default value for the LINECON parameter when used with an SDLC line is 01000001, or hex 41.

The default value for each bit is underlined in the *Bit Value* column.

To configure the iSeries server to a 3684 retail controller, use the following table.

LINECON Bit	Bit Value	iSeries Parameter and Value	Notes
0	<u>0</u>	None	Enabled at initial microprogram load (IML). There is no equivalent parameter for the iSeries system. Specify 0 to indicate that the controller is enabled at IML, or 1 to indicate that the controller is not enabled at IML.
	1	None	
1	0	NRZI(*NO)	Specifies NRZI data encoding with leading pads (1) or non-NRZI without leading pads (0).
	<u>1</u>	NRZI(*YES)	
2 and 3	<u>00</u>	SWITCHED(*YES) and CNN(*SWTPP)	Bit 2: Specify 1 is using nonswitched communications, or 0 if using switched communications. If switched, the SENDID parameter must also be specified.
	01	Not valid	
	10	SWITCHED(*NO) and CNN(*NONSWTPP)	Bit 3: Specify 1 if using a multipoint communications protocol, or 0 if not. 01 is not a valid combination for these bits.
	11	SWITCHED(*NO) and CNN(*MP)	
4	<u>0</u>	SNBU(*NO)	Switched network backup.
	1	SNBU(*YES)	
5	<u>0</u>	MODEMRATE(*FULL)	Data rate select speed.
	1	MODEMRATE(*HALF)	
6	<u>0</u>	DUPLEX(*HALF)	Data carrier setting.
	1	DUPLEX(*FULL)	
7	0	None	Answer tone generation. There is no equivalent parameter for the iSeries system. Specify 0 to indicate that the controller generates the answer tone, or 1 to indicate that the answer tone is omitted.
	<u>1</u>	None	

Match iSeries system parameters for 4680/4690 LINE parameter

You must coordinate parameters between the iSeries server and the 4680 or 4690 retail controller. The following table lists those parameters. The 4680 controller requires configuration of the SDLC/SNA LINE parameter.

iSeries parameters are listed in alphabetical order; the commands on which the parameters are specified are included in the rightmost column of the table.

For more information about configuring the 4680, see the *IBM 4680 Store System: Programming Guide*.

To configure the iSeries server to a 4680/4690 controller:

- See “Example: iSeries server connection to a 4690 retail controller” on page 66 for an example of an iSeries server connecting to a 4690 retail controller.
- Use the following table to connect an iSeries server to a 4690 retail controller.

iSeries Prompt	iSeries Parameter	4680 Line Parameter
Connection type	CNN	<p>4680 CONNECTION TYPE parameter value must be coordinated with the values specified for the iSeries CNN and SWTCNN parameters on the CRTLNSDLC command and with the SWITCHED and INLCNN parameters on the CRTCTLRTL command.</p> <ul style="list-style-type: none"> • If CNN(*NONSWTPP) and SWITCHED(*NO) are specified for the iSeries system, specify CONNECTION TYPE = 1 for the 4680. • If CNN(*MP) and SWITCHED(*NO) are specified for the iSeries system, specify CONNECTION TYPE = 2 for the 4680. • If CNN(*SWTPP), SWITCHED(*YES), INLCNN(*DIAL), and either SWTCNN(*DIAL) or SWTCNN(*BOTH) are specified for the iSeries system, specify CONNECTION TYPE = 3 for the 4680. • If CNN(*SWTPP), SWITCHED(*YES), INLCNN(*DIAL), and either SWTCNN(*DIAL) or SWTCNN(*BOTH) are specified for the iSeries system, specify CONNECTION TYPE = 4 for the 4680. This configuration allows the 4680 to manually answer calls from the iSeries system or to manually call the iSeries system. • If CNN(*SWTPP), SWITCHED(*YES), INLCNN(*ANS), and either SWTCNN(*ANS) or SWTCNN(*BOTH) are specified for the iSeries system, specify CONNECTION TYPE = 4 for the 4680. This configuration requires the 4680 to manually call the iSeries system.
Initial connection	INLCNN	See description for the CNN (<i>Connection type</i>) parameter.
Modem data rate select	MODEMRATE	4680 DATA RATE parameter must match the MODEMRATE parameter specified on the iSeries CRTLNSDLC command.
NRZI data encoding	NRZI	4680 NRZI MODE parameter must match the NRZI parameter specified on the iSeries CRTLNSDLC command.
Station address	STNADR	4680 STATION ADDRESS parameter must match the STNADR parameter specified on the iSeries CRTCTLRTL command.
Switched connection	SWITCHED	See description for the CNN (<i>Connection type</i>) parameter.
Switched connection	SWTCNN	See description for the CNN (<i>Connection type</i>) parameter.

Match iSeries system parameters for 4680/4690 LINK parameter

You must coordinate parameters between the iSeries server and the 4680 store controller. The following tables lists the parameter values. The 4680 controller requires configuration of the SDLC/SNA LINK parameter.

iSeries parameters are listed in alphabetical order; the commands on which the parameters are specified are included in the rightmost column of the table.

For more information about configuring the 4680 controller, see the *IBM 4680 Store System: Programming Guide*.

To configure the iSeries server to a 4680/4690 controller:

- See “Example: iSeries server connection to a 4690 retail controller” on page 66 for an example of an iSeries server connecting to a 4690 retail controller.
- Use the following table to connect an iSeries server to a 4680/4690 retail controller.

iSeries Prompt	iSeries Parameter	4680 Link Parameter
Exchange identifier	EXCHID	For switched lines only, the 4680 EXCHANGE ID parameter must match the EXCHID parameter specified on the iSeries CRTCTLRTL command.

iSeries Prompt	iSeries Parameter	4680 Link Parameter
Local location address	LOCADR	4680 SESSION ADDRESS parameter must match the LOCADR parameter specified on the iSeries CRTDEVRTL command. Session address 01 is reserved for host command processor sessions.
SSCP identifier	SSCPID	4680 SSCP ID parameter must match the SSCPID parameter specified on the iSeries CRTCTLRRTL command.

Match iSeries system parameters for 4684 retail controllers

You must coordinate parameter values with the iSeries server and the 4684 retail controller when running IBM Retail Industry Programming Support Services (RIPSS). The following table lists those parameters.

iSeries parameters are listed in alphabetical order; the commands on which the parameters are specified are included in the rightmost column of the table.

For more information about configuring for RIPSS on the 4684, see the *IBM Retail Industry Programming Support Services: Planning and Installation Guide*, SC33-0650.

To configure the iSeries server to a 4684 controller:

- See "Example: iSeries server connection to a 4690 retail controller" on page 66 for an example of an iSeries server connecting to a 4690 retail controller.
- Use the following table to connect to a 4690 retail controller.

iSeries Prompt	iSeries Parameter	RIPSS Configuration Display	RIPSS Prompt
LAN remote adapter address	ADPTADR	TRDLC Server Data	<i>Local node (Hex)</i> For Token-Ring connections, the values specified for the RIPSS configuration and for the iSeries CRTCTLRRTL command must match.
Local adapter address	ADPTADR	TRDLC Server Data	<i>Remote node (Hex)</i> For Token-Ring connections, the values specified for the RIPSS configuration and for the iSeries CRTLINTRN command must match.
Destination service access point	DSAP	TRDLC Server Data	<i>Local SAP (Hex)</i> For Token-Ring connections, the values specified for the RIPSS configuration and for the iSeries CRTCTLRRTL command must match.
Duplex	DUPLEX	SDLC Server Data	<i>4-wire constant RTS?</i> For SDLC connections, the values specified for RIPSS and iSeries configurations must match: <ul style="list-style-type: none"> • If the RIPSS response is N, DUPLEX(*HALF) must be specified for the CRTLINSDLC command. • If the RIPSS response is Y, DUPLEX(YES) must be specified for the CRTLINSDLC command.

iSeries Prompt	iSeries Parameter	RIPSS Configuration Display	RIPSS Prompt
Exchange identifier	EXCHID	SDLC Server Data	<p><i>Block number (hex) and XID (hex)</i></p> <p>For SDLC connections, the values specified for the RIPSS configuration must match the value specified in the EXCHID parameter of the CRTCTRLRTL command. The EXCHID parameter must be specified as: xxxyyyyy, where xxx matches the RIPSS <i>Block number</i> and yyyy matches the RIPSS <i>XID</i>.</p> <p>For switched connections, the block number must be 005.</p>
Local location address	LOCADR	SNA Server Data, Session Data	<p><i>LOC Address (Dec)</i></p> <p>The values specified for the RIPSS configuration must match the values specified on the LOCADR parameter of the CRTDEVRTL command.</p> <p>Note that the RIPSS <i>LOC Address</i> is a decimal value; the iSeries value is a 2-digit hexadecimal number.</p>
NRZI data encoding	NRZI	SDLC Server Data	<p><i>Data coding/decoding</i></p> <p>For SDLC connections, the values specified for the iSeries CRTLNSDLC command and the RIPSS configuration must match:</p> <ul style="list-style-type: none"> • If the RIPSS response is NRZI, NRZI(*YES) must be specified for the CRTLNSDLC command. • If the RIPSS response is NRZ, NRZI(*NO) must be specified for the CRTLNSDLC command.
SSCP identifier	SSCPID	HST Server Data	<p><i>SSCP Name</i></p> <p>For SDLC connections, if used, the value specified by the RIPSS configuration must match the last 10 digits of the SSCPID parameter specified on the CRTCTRLRTL command.</p>
Station address	STNADR	SDLC Server Data	<p><i>Poll address (hex)</i></p> <p>For SDLC connections, values specified for the iSeries CRTCTRLRTL command and the RIPSS configuration must match.</p>

Example: iSeries server connection to a 4690 retail controller: The iSeries server retail communications provide the ability to attach retail controllers to the iSeries server. Retail communications manage data with the intersystem communications function (ICF) file. For communications to begin between programs, the retail communications device must first be configured and varied on.

Example: iSeries server to 4690 LU0 connection over token-ring network

Read a description of this figure at “Example details: iSeries server connection to 4690 LU0 over token-ring network” on page 88.

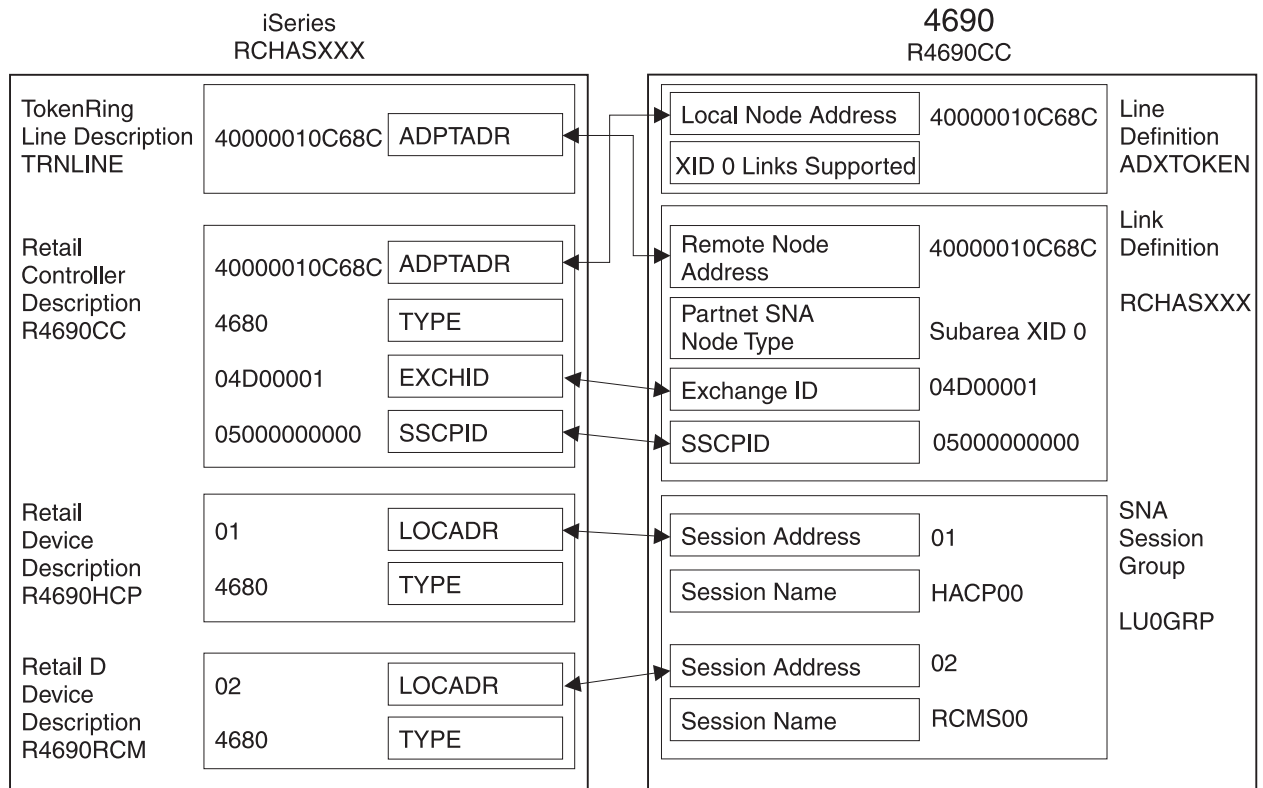

RV4T200-01

Figure 11. Figure showing how configuration parameters are related and configured. Follow the above link to detailed description for more information.

Example: iSeries server to 4690 PEER connection over token-ring network

Read a description of this figure at “Example details: iSeries server connection to 4690 peer over token-ring network” on page 89.

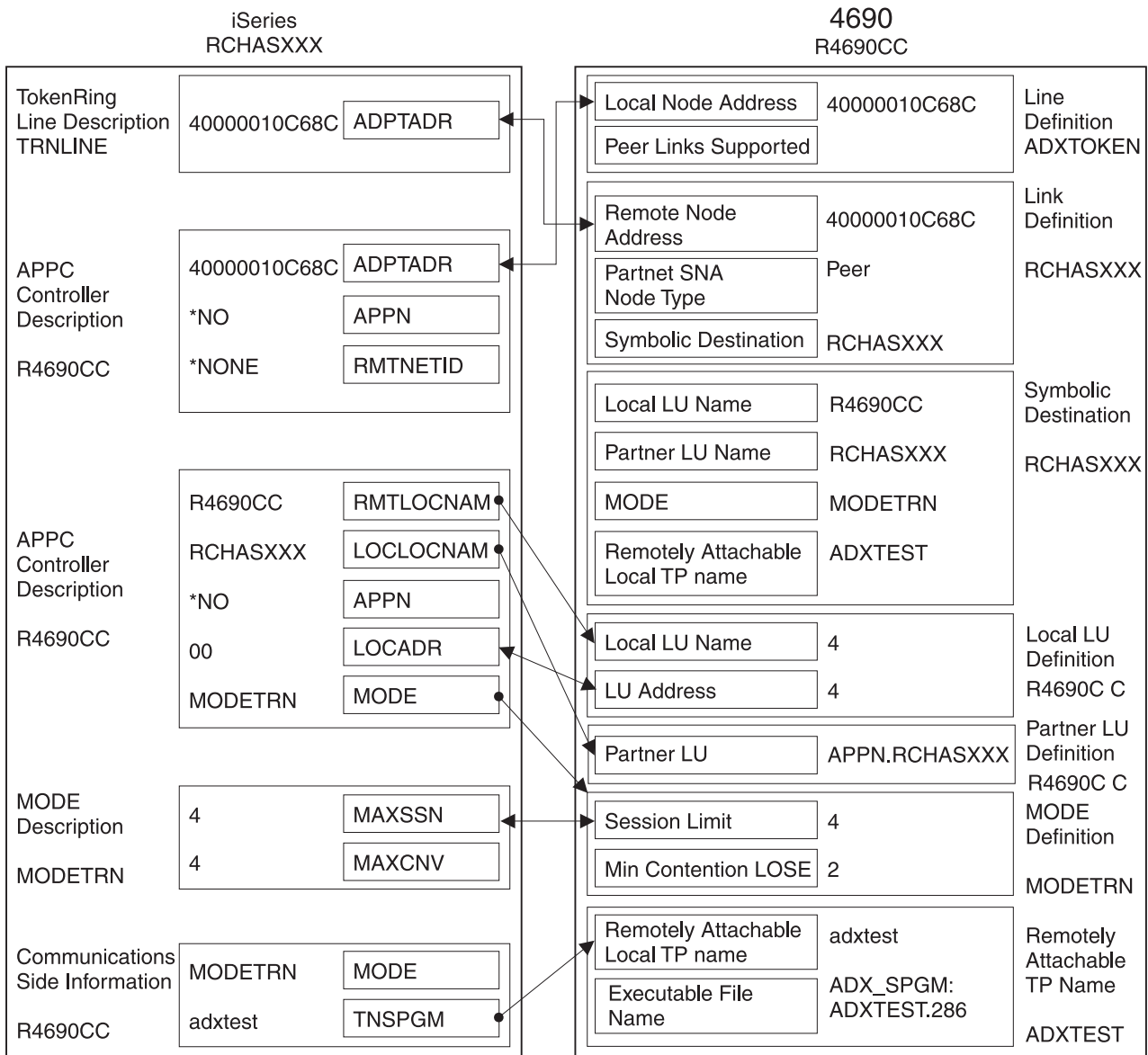

RV4T201-1

Figure 12. Figure showing how configuration parameters are related and configured. Follow the above link to detailed description for more information.

Common networking standards

These topics introduce the types of common networking standards that are supported by the iSeries system. See the following topics for more information:

- Local area network standards
- Wide area network standards

Local area network standards

A LAN (local area network) is a communications system that allows interconnection and the sharing of resources between independent devices within a moderately sized geographic area. These topics introduce the types of local area networks that are supported by the iSeries system:

- DDI (distributed data interface) networks

- Ethernet
- Token-ring
- Wireless networks

Distributed data interface network

FDDI is an optical fiber-based local area network (LAN) that uses the American National Standards Institute (ANSI) 3T9.5 standard for a token-passing ring media access control (MAC) protocol. Stations, concentrators, and bridges in a FDDI network are physically connected to one of the counter-rotating rings or both of the counter-rotating rings. The rings operate at 100 Mbps.

FDDI networks allow devices to be attached to one or both of the rings. Typically only the primary ring in a FDDI network is active. The secondary ring is used to maintain the network when a dual-access station or a concentrator becomes inactive.

Ethernet networks

Ethernet is one type of local area network (LAN) topology that is supported by the operating system. i5/OS Ethernet provides support for the Digital Equipment Corporation, Intel[™] Corporation, and Xerox standard (Ethernet Version 2) and the IEEE 802.3 standard.

Half-duplex Ethernet

Generally, multiple stations in an Ethernet network show a single data path. Therefore, only one station may transmit data at a time. This is called half-duplex Ethernet. The station may transmit only or receive only, but not both simultaneously.

Full-duplex Ethernet

Full-duplex Ethernet enables stations to simultaneously send and receive data on the network, eliminating collisions. This is accomplished through the use of a full-duplex LAN switch. Ethernet switching splits a large Ethernet into smaller segments. Full-duplex Ethernet requires the following:

- Twisted-pair cable transmission medium
- Ethernet network interface cards
- A full-duplex LAN switch

Full-duplex 10 Mbps Ethernet has simultaneous 10 Mbps receiving and 10 Mbps sending paths.

Fast Ethernet

Fast Ethernet standard (IEEE 802.3U) increases Ethernet by operating speeds from 10 Mbps to 100, half or full duplex. The iSeries Ethernet adapters support 100BASE-TX network devices that use category 5 shielded and unshielded twisted-pair (STP, UTP) cable.

For more information, see the Ethernet topic collection.

Token-ring networks

A token-ring network is one LAN topology that sends data in one direction throughout a specified number of locations by using the token. The token is the symbol of authority for control of the transmission line. This token allows any sending station in the network (ring) to send data when the token arrives at that location.

Stations in a token-ring network are physically connected, typically in a star-wired ring topology, to a wiring concentrator such as the IBM 8228 Multistation Access Unit. The concentrator serves as a logical ring around which data is transmitted at 4 million, 16 million, or 100 million bits per second (Mbps). Each station is connected to the concentrator typically by shielded twisted pair (STP) cabling.

Full-duplex token ring

In full-duplex token ring, which is also called DTR (dedicated token ring), switching hubs enable stations to send and receive data on the network simultaneously. A token-ring switching hub divides the network into smaller segments. When a station transmits its data packet, the token-ring switch reads the packet's destination address information and forwards the data directly to the receiving station. The switch then establishes a dedicated connection between the

two stations, enabling data to be transmitted and received at the same time. In full-duplex token ring, the token-passing protocol is suspended. The network in effect becomes a 'tokenless' token ring. Full-duplex token ring increases sending and receiving bandwidth for connected stations, improving network performance.

For more information, see the Token ring topic collection.

Wireless network

The more mobile your employees, the more you should consider a wireless network. The portable transaction computers (PTCs) make it possible for direct connection between the office and offsite locations.

The iSeries wireless network is a LAN that uses a Carrier Sense Multiple Access with Collision Avoidance (CSMA/CA) protocol to provide media access to competing stations. iSeries wireless communications use spread-spectrum, direct sequence radio in the 2.4 gigahertz (GHz) band to provide connectivity between the iSeries wireless LAN adapter and remote stations. Remote stations can be PTCs that are running 5250 emulation or LAN-connected systems that are equipped with compatible wireless adapters. There are other implementations of wireless LAN.

Wide area network standards

A wide area network (WAN) is a data communications network designed to serve an area of hundreds or thousands of miles--for example, public and private packet-switching networks, and national telephone networks.

These topics introduce the types of wide area networks that are supported by the iSeries system:

- Asynchronous communications
- Binary synchronous communications
- Frame relay
- Synchronous data link control network
- X.25 network
- X.21 network

Asynchronous communications

i5/OS asynchronous communications support allows an iSeries application program to exchange data with a remote system or device using either an asynchronous (start-stop) or X.25 line. iSeries application programs can be written in ILE COBOL/400[®], ILE RPG/400[®], ILE C/400[®], or FORTRAN/400 languages. Asynchronous communications support includes file transfer support (also used with other communications types) and interactive terminal facility (ITF). Asynchronous communications support provides program-to-program and program-to-device communications between systems that use asynchronous (start-stop) or X.25 lines. For X.25 lines, it also supplies an integrated packet assembler/disassembler (PAD) (1) that follows CCITT recommendations X.3, X.28, and X.29.

Asynchronous communications support allows you to send data to and receive data from a remote program or device attached by either an asynchronous (start-stop) or an X.25 line. Your application program must provide the data stream required by the remote device. Asynchronous communications support packages your data stream in either a start-stop format or within X.25 data packets.

For more information, see the book *Asynchronous Communications Programming*  (SC41-5444).

Binary synchronous communications

(BSC) is a data communications line protocol that uses a standard set of transmission control characters and control character sequences to send binary-coded data over a communications line. Binary synchronous communications equivalence link (BSCCEL) support is the intersystem communications function (ICF) support on the iSeries system that provides binary synchronous communications with a remote system or device. BSCCEL also supplies online and batch communications between application

programs on different BSC systems. iSeries application programs can be written in the Integrated Language Environment® (ILE) C/400*, ILE COBOL/400*, ILE FORTRAN/400*, or ILE RPG/400* programming languages.

For more information, see the book BSC Equivalence Link Programming  (SC41–5445).

Frame relay networks

Frame relay is a protocol that defines how frames are routed through a fast-packet network based on the address field in the frame. Frame relay takes advantage of the reliability of data communications networks to minimize the error checking done by the network nodes. This provides a packet-switching protocol similar to, but much faster than, X.25. The high speed that can be obtained through frame-relay networks makes it well suited for wide area network (WAN) connectivity. Frame relay is commonly used to connect two or more LAN bridges over large distances.

The iSeries system supports these frame-relay network connections:

- Frame relay direct network: Allows data that uses SNA or TCP/IP communications over a frame-relay network to move at speeds of up to 2.048 Mbps. This support allows a network of systems to communicate using the frame-relay network as a backbone, without the need for multiple leased T1 lines.
- Bridged frame relay network: Allows iSeries to communicate over a frame-relay network through a remote bridge. The bridge is attached to a token-ring, Ethernet, or distributed data interface (DDI) network. Bridged frame relay connections allow iSeries to communicate with stations on the remote local area network (LAN) as if they were attached locally to the LAN medium.

For more information, see the Frame relay topic collection.

Synchronous data link control network

SDLC has the following meanings:

- A form of communications line control that uses commands to control the transfer of data over a communications line.
- A communications discipline that conforms to subsets of the Advanced Data Communication Control Procedures (ADCCP) of the American National Standards Institute (ANSI) and high-level data link control (HDLC). These standards are part of the International Organization of Standardization.

SDLC is used for transferring synchronous, code-transparent, serial-by-bit information over a communications line. Transmission exchanges may be duplex or half-duplex over switched or nonswitched lines. The configuration of the connection may be point-to-point, multipoint, or loop.

Note: SDLC supports traditional iSeries communication protocols, such as APPC, but does not support TCP/IP.

X.25 network

X.25 is a Telecommunications Standardization Sector (ITU-T) recommendation that defines the physical level (physical layer), link level (data link layer), and packet level (network layer) of the OSI reference model. A X.25 network is an interface between data terminal equipment (DTE) and data circuit-terminating equipment (DCE) that operates in the packet mode, which is connected to public data networks by dedicated circuits. X.25 networks use the connection-mode network service.

An iSeries X.25 line can be connected through a packet-switching data network (PSDN) and an adjacent remote system by using either a nonswitched or switched physical line. A switched line connection is one that is established on demand between the iSeries system and the X.25 network. On nonswitched line connections, the iSeries system supports both switched virtual circuits (SVCs) and permanent virtual circuits (PVCs). Only SVCs are supported on switched physical lines.

One X.25 line supports one or more virtual circuits. Each virtual circuit can support one of the following:

- One or more Systems Network Architecture (SNA) sessions that can include Advanced Program-to-Program communications (APPC), SNA upline facility , remote work stations, or finance communications
- One connection to an asynchronous communications host system (the primary or controlling computer in a communications network)
- One connection to an asynchronous device through the X.25 network packet assembler/disassembler (PAD) function
- One connection to an asynchronous communications host system through iSeries PAD emulation
- One user-defined communications facility
- One Transmission Control Protocol/Internet Protocol (TCP/IP) link to an adjacent IP node or gateway. (A gateway is a device that is used to connect two systems that use two different communications protocols)

X.21 network

In data communications, a specification of the International Telegraph and Telephone Consultative Committee (CCITT) that defines the connection of data terminal equipment to an X.21 (public data) network.

The iSeries system supports short—hold mode (SHM) operation for use with X.21 circuit—switched networks. X.21 short—hold mode is characterized by a series of connections and disconnections with a remote controller or system on an X.21 circuit—switched line. When there is no data traffic, the connection is broken, but the SNA sessions remain active. When either side has data to send, the connection is established again.

Troubleshoot communications problems

If you suspect you have a problem with communications connectivity, the iSeries system provides a set of tools to help you with problem analysis tasks. The list below contains some of the more common tools for communications problem analysis.

You can do the following to identify communication problems:

- “Display message queues to solve communication problems”
- “Display the Product Activity Log to solve communication problems” on page 73
- “Display the Print Error Log to solve communication problems” on page 73

You can do the following to solve communication problems:

- “Solve communication problems using communications trace” on page 74
- “Solve communication problems using the system problem log” on page 77
- “Solve communication problems using status information” on page 77
- “Considerations for system tuning during error recovery” on page 77
- “Use error messages to aid in error recovery” on page 78
- “Solve communication problems using reason codes” on page 78

Display message queues to solve communication problems

Message queues receive some messages that are related to communications failures. The message lists possible causes of the problem and additional information, depending on the problem, and the suggested problem analysis tool.

To display message queues, follow these steps:

1. On the iSeries system command line, type `DSPMSG MSGQ(XXXX)`, in which `XXXX` is:
 - The message queue identified by the `QCFGMSGQ` system value
 - The default value is `QSYSOPR`
 - Or, message queue if the system value has been changed
 - For lines, controllers, and devices which support the `MSGQ` parameter, the message queue is specified in the configuration object

- For display devices, the message queue that matches the device name
2. Press the Enter key.
 3. In the Display Message display, read the messages pertaining to communications problems that are displayed in the message queue. The object name in the message directs you to the communications objects in error.
 4. For messages in the queue with an * in the farthest left position, press F14 to perform additional tests. This calls the Work with Problems tool.

For related information, see:

- Message queues
- “Solve communication problems using the system problem log” on page 77
- “Job logs and communication problems” on page 74
- “Communications trace and communication problems” on page 75
- “Use error messages to aid in error recovery” on page 78

Display the Product Activity Log to solve communication problems

The Print Error Log and the Product Activity Log provide you with important information for solving communications problems.

To view the product activity log, do the following:

1. Display or print the product activity log using these steps:
 - Type STRSST (Start System Service Tools) on any iSeries system command line, enter your service tools user ID and password, and press the Enter key.
 - In the System Service Tools menu, select Option 1 to display or print the product activity log.

For more information about the Product Activity Log, see the Communications Management  book.

For related information, see:

- History logs
- “Communications trace and communication problems” on page 75
- “Use error messages to aid in error recovery” on page 78

Display the Print Error Log to solve communication problems

The Print Error Log and the Product Activity Log provide you with important information for solving communications problems.

To view the Print Error Log, do the following:

1. Type PRTERLOG (Print Error Log) on any iSeries system command line. Press the Enter key.
The command places a formatted printer file of the machine error log in a spooled printer file that is named QPCSMPT or in a specified output file.
2. Find and read these error logs.

For more information about displaying the Print Error Log, see the Communications Management  book.

A variety of job logs might contain information that helps you determine the cause of a communications problem. For a detailed description of these job logs, see: “Job logs and communication problems” on page 74

Job logs and communication problems

A variety of job logs might contain information that helps you determine the cause of a communications problem. Many of these logs contain messages that can help you understand what the system has done concerning your communications functions. The following are some of the most useful jobs to review when you have a communications problem:

QSYSARB

System arbiter. This job log is for devices, and communications in general. It also contains ONLINE at IPL messages.

QSYSCOMM1

Communications and input/output system job. This job log is for problem logging and for local area network (LAN) manager messages. It also contains ONLINE at IPL messages for network servers and their lines.

QCMNARB01 through QCMNARB99

Communications arbiter. These job logs contain information for communications startup, take-down, and error recovery.

QLUS

Logical unit services.

QLUR

Logical unit (LU) 6.2 resynchronization job. This job log is for two-phase commit synchronization processing.

QPASVRP

Target 5250 display station pass-through primary server job. This job log is for target pass-through communications functions.

QPASVRS

Target 5250 display station pass-through secondary server job. These contain more detailed messages for target pass-through communication functions

Subsystem jobs (QINTER and QCMN)

Interactive subsystem and communication subsystem. These job logs are for subsystem jobs.

For more information on pass-through primary jobs, see the Remote Work Station Support  book.

Solve communication problems using communications trace

Sometimes, program debugging tasks are easier if you can trace the data that is sent and received on the communications line or within the network server. To perform a communications trace, you must have IBM *SERVICE special authority or be authorized to the Service Trace function of i5/OS through iSeries

Navigator. See iSeries Security Reference  (SC41-5302), Chapter 4 User Profiles, for more information on this special authority.

To run a communications trace, see Perform a communications trace for the specific steps you should use.

The following commands might be used to perform a communications trace.

STRSST (Start Service Tools)

The STRSST command takes you to a menu of tools to obtain error log information and communications trace information. For a detailed description of system service tools, see: "Communications trace and communication problems" on page 75

STRCMNTRC (Start Communications Trace)

The STRCMNTRC command starts a communications trace for the specified line, network interface description, or network server description. The communications trace continues until one of the following occurs:

- The system runs the End Communications Trace (ENDCMNTRC) command
- A physical line problem causes the trace to end
- The Communications Trace function of the STRSST command ends the trace
- The *STOPTRC parameter is specified, and the buffer becomes full

ENDCMNTRC (End Communications Trace)

The ENDCMNTRC command ends the trace currently running on the specified line, network

interface description, or network server description. The ENDCMNTRC command saves the communications trace buffer and the associated System Licensed Internal Code (SLIC) data.

PRTCMNTRC (Print Communications Trace)

The PRTCMNTRC command writes the communications trace data for the specified line, network interface description, or network server description to a spooled file or a database file. The system can print trace data multiple times in either form, and parameters on the command allow for dividing and formatting of the data.

DLTCMNTRC (Delete Communications Trace)

The DLTCMNTRC command deletes the communications trace buffer and associated SLIC data for the specified line, network interface description, or network server description. The communications trace can be deleted once the trace has ended.

CHKCMNTRC (Check Communications Trace)

The CHKCMNTRC command returns the communications trace status for a specific line, network interface description, or network server description. The CHKCMNTRC command returns status for all of the traces of a specific type that exist on the system. The system returns the status through a message.

TRCCPIC (Trace Common Programming Interface (CPI) Communications)

You can start to trace Common Programming Interface (CPI) Communications either before running a job or after a job is active to find out where the error might have occurred. The TRCCPIC command captures information about CPI-Communications calls that is processed by your program.

For more information on how to access System Service Tools, see the Backup and Recovery  book.

Communications trace and communication problems

You might sometimes need to obtain an error log printout or communications trace data that your IBM service representative can review. For the line trace, someone familiar with the protocol used on the line might need to review the files. To perform a communications trace, you must have IBM *SERVICE special authority or be authorized to the Service Trace function of i5/OS through iSeries Navigator. See iSeries Security Reference (SC41-5302), Chapter 4 User Profiles, for more information on this special authority.

Use the communications trace function in the following situations:

- Message information or other problem analysis is not sufficient to identify a problem
- Communications support personnel suspects a protocol error
- To verify that the system sends and receives valid data

You can trace multiple lines from each workstation by using the communications trace option. The system traces a maximum of two lines on the same communications controller subsystem at the same time. Only one trace can exist for the same configuration object at the same time. The system supports all line speeds and protocols.

For more information about these tests, contact your IBM service representative.

Trace Common Programming Interface (CPI) Communications (TRCCPIC) command

You can start to trace Common Programming Interface (CPI) Communications either before running a job or after a job is active to find out where the error might have occurred. The TRCCPIC command captures information about CPI-Communications calls that are processed by your program. The system collects trace information in a current job, or in a job that is serviced by a Start Service Job (STRSRVJOB) command. (For a CPI Communication program you could trace a job that is started as a result of a received program start request.) You can issue the TRCCPIC command in one of the following ways:

- Using the System Menu
- Typing TRCCPIC *ON on a command line
- Adding the TRCCPIC command to a control language (CL) or a REstructured eXtended eXecutor (REXX) program
- Typing TRCCPIC on the command line and pressing F4 (Prompt)

If you type TRCCPIC on the command line and press F4, an initial prompt is displayed for the *Trace Option Setting*. If *ON is specified and you press enter, the Trace CPI Communications display appears.

This display enables you to set the following parameters:

Trace option setting

Specifies whether the collection of trace information is to be started, stopped, or ended.

***ON**

Starts Trace CPI Communications. This is the default value for the command.

***OFF**

Stops Trace CPI Communications. The current information is written to the spooled printer file or to the database file, and the trace table. The trace information is then deleted.

***END**

Ends Trace CPI Communications. The trace table and all trace information are destroyed.

Maximum storage to use

Specifies the maximum amount of storage to use for the trace information collected. The prompt appears only if you have selected *ON for the *Trace option setting* prompt.

200 K

The number of bytes (1 K equals 1024 bytes) of storage. This is the default value.

1-16000 K

The valid range for the maximum number of bytes used for storing collected trace information.

Trace full

Specifies whether new trace records replace old trace records or whether the trace is stopped when the maximum storage that you specified has been reached. This prompt appears only if you have selected *ON for the *Trace option setting* prompt.

***WRAP**

When the trace storage area is full, new trace information is written over the old trace information, starting at the beginning of the storage area. This is the default value.

***STOPTRC**

No new trace information is saved when the trace storage area is full. You must reissue the TRCCPIC command, specifying (*OFF) for the SET parameter, to retrieve the output of the trace information collected in the trace storage area.

User data length

Specifies the maximum length of user data to be saved for each trace record in the storage area. This prompt affects only the tracing of user data on the Send_Data and Receive calls. This parameter does not affect the tracing of log data on Set_Log_Data, Send_Error, or Deallocate calls. This prompt appears only if you specified *ON on the *Trace option setting* prompt.

128

The number of bytes for the user data length. This is the default value.

0-4096

The valid range of bytes for the user data length.

Trace Common Programming Interface (CPI) Communications continues to collect trace records until you stop the trace or until the trace storage area becomes full. The amount of trace storage depends on the value that is specified on the *Trace full* prompt. If the trace storage area becomes full and the collection of trace records stops, you must enter the TRCCPIC command again to create output. The output that is created by the TRCCPIC command is directed either to the spooled printer file, QSYSPT, or to a database output file that you specify. If the output file that you specify already exists, it must have the same attributes as the system-supplied file, QACM0TRC.

You can stop a trace procedure in one of the following ways:

- Using the System Menu

- Typing TRCCPIC *OFF on the command line
- Adding the TRCCPIC command to a CL or a REXX program
- Typing TRCCPIC on the command line and pressing F4 (Prompt)

Type TRCCPIC on the command line and press F4. Specify *OFF for the *Trace option setting* and you are prompted for the OUTPUT parameter.

Solve communication problems using the system problem log

Error conditions that are communications-related can make entries in the system problem log. You can access the log to see the lists of problems that are detected by the system or by the user.

To access the system problem log, type WRKPRB on any iSeries system command line, and press F4.

Tips: You can select a subset of the problems that are listed in the problem log by selecting the problem status. A problem that is listed in the log has one of the following as a status:

- OPENED: The problem was identified; problem analysis has not been run.
- READY: The system has run problem analysis; the problem is ready to be prepared.
- PREPARED: The system added information that relates to the problem.
- SENT: The problem was sent to the service support location.

You can also sort the WRKPRB display by the date the problem was entered into the log.

Note: Use the WRKPRB command for the menu options, additional problem analysis, or documenting problem records.

Solve communication problems using status information

You can often diagnose the communications problem by checking communications status. Status information for network servers, network interfaces, lines, controllers, or devices might represent the symptom of the problem.

To check and change the communication configuration on the system, do the following:

1. Type the Work with Configuration Status (WRKCFGSTS) command on any iSeries system command line.
2. Press F4. The Work with Configuration Status display appears.
3. Specify the configuration type for the CFGTYPE parameter.
4. Specify the configuration description for the CFGD parameter.

Note: You can sort this list produced by WRKCFGSTS based on the status of the objects using the STATUS parameter. For example, if you want to see just the failed objects, specify STATUS(*FAILED).

Considerations for system tuning during error recovery

The overall performance tuning that is done by the system can play a significant role during error recovery scenarios. For example, you might need to change the machine pool if it is too small because it can cause excessive error recovery times.

- Performance Adjustment – QPFRADJ

The automatic performance adjustment function of the system is set to 2 when the system is shipped.

The system can automatically adjust the performance of the system based on this value. Automatic adjustment might be a desirable feature, particularly when unexpected loads hit the system. Automatic adjustment can help the system perform better through these peak loads.

- Subsystem considerations

You should consider dividing communications users (whether they are remote workstation or APPC communication users) into multiple subsystems. If communications fails, all users who are in a single subsystem might be affected as a result of the communications recovery that is performed on their systems. For more information, see:

- “Considerations for subsystem configuration for error recovery performance” on page 11

Use error messages to aid in error recovery

When problems occur in communications, there are many places you can look for error messages and additional information to help resolve the problems. See the topics below for the most common places to look for error information.

- Messages queues, see “Display message queues to solve communication problems” on page 72
- Job logs, see “Job logs and communication problems” on page 74
- Other logs, see “Display the Product Activity Log to solve communication problems” on page 73 and “Display the Print Error Log to solve communication problems” on page 73
- Start Service tools, see “Communications trace and communication problems” on page 75
- Communications trace, see “Solve communication problems using communications trace” on page 74

Solve communication problems using reason codes

When the local system rejects an incoming program start request, a message is sent to the system operator message queue. You can use the message information to determine why the program start request was rejected.

Refer to the following table for an explanation on reason codes for failed program start requests.

Table 2. Reason Codes for Rejected Program Start Requests

Reason Code	Reason Description
401	Program start request received to a device that is not allocated to an active subsystem.
402	Requested device is currently being held by a Hold Communications Device (HLDCMNDEV) command.
403	User profile is not accessible.
404	Job description is not accessible.
405	Output queue is not accessible.
406	Maximum number of jobs defined by subsystem description are already active.
407	Maximum number of jobs defined by communications entry are already active.
408	Maximum number of jobs defined by routing entry are already active.
409	Library on library list is exclusively in use by another job.
410	Group profile cannot be accessed.
411	Insufficient storage in machine pool to start job.
412	System value not accessible.
413	QSERVER not started
501	Job description was not found.
502	Output queue was not found.
503	Class was not found.
504	Library on initial library list was not found.
505	Job description or job description library is damaged.
506	Library on library list is destroyed.
507	Duplicate libraries were found on library list.
508	Storage-pool defined size is zero.
602	Transaction program-name value is reserved but not supported.
604	Matching routing entry was not found.
605	Program was not found.
704	Password is not valid.
705	User is not authorized to device.

Table 2. Reason Codes for Rejected Program Start Requests (continued)

Reason Code	Reason Description
706	User is not authorized to subsystem description.
707	User is not authorized to job description.
708	User is not authorized to output queue.
709	User is not authorized to program.
710	User is not authorized to class.
711	User is not authorized to library on library list.
712	User is not authorized to group profile.
713	User ID is not valid.
714	Default user profile is not valid.
715	Neither password nor user ID was provided, and no default user profile was specified in the communications entry.
718	No user ID.
722	A user ID was received but a password was not sent.
723	No password was associated with the user ID.
725	User ID does not follow naming convention.
726	User profile is disabled.
730	Password has expired.
801	Program initialization parameters are present but not allowed.
802	Program initialization parameter exceeds 2000 bytes.
803	Subsystem is ending.
804	Prestart job is inactive or is ending.
805	WAIT(NO) was specified on the prestart job entry and no prestart job was available.
806	The maximum number of prestart jobs that can be active on a prestart job entry was exceeded.
807	Prestart job ended when a program start request was being received.
901	Program initialization parameters are not valid.
902	Number of parameters for program not valid.
903	Program initialization parameters required but not present.
1001	System logic error. Function check or unexpected return code encountered.
1002	System logic error. Function check or unexpected return code encountered while receiving program initialization parameters.
1501	Character in procedure name not valid.
1502	Procedure not found.
1503	System/36 environment library not found.
1504	Library QSSP not found.
1505	File QS36PRC not found in library QSSP.
1506	Procedure or library name is greater than 8 characters.
1507	Current library not found.
1508	Not authorized to current library.
1509	Not authorized to QS36PRC in current library.
1510	Not authorized to procedure in current library.
1511	Not authorized to System/36 environment library.
1512	Not authorized to file QS36PRC in System/36 environment library.
1513	Not authorized to procedure in System/36 environment library.
1514	Not authorized in library QSSP.
1515	Not authorized to file QS36PRC in QSSP.
1516	Not authorized to procedure in QS36PRC in QSSP.
1517	Unexpected return code from System/36 environment support.
1518	Problem phase program not found in QSSP.
1519	Not authorized to problem phase program in QSSP.
1520	Maximum number of target programs started (100 per System/36 environment).
2501	System logic error. Function check or unexpected return code encountered while processing a program start request.

Table 2. Reason Codes for Rejected Program Start Requests (continued)

Reason Code	Reason Description
2502	Temporarily unable to allocate needed resources for a program start request.
2503	No subsystem accepting program start requests for this device.

Reference Information

Example details: iSeries to host server connection over a nonswitched SDLC line

Figure 1 on page 26 shows the iSeries system values that need to match the Virtual Telecommunications Access Method (VTAM) values when you use a nonswitched synchronous data link control (SDLC) line. The following table describes the relationships shown in Figure 1 on page 26 between the iSeries system values and the VTAM values. The values shown and described here are example values.

Table 3. iSeries system value relationship to VTAM values

iSeries system parameter name and value	iSeries parameter value description	VTAM Licensed Program value
Network Attribute: LCLLCONAME = R4082A14	The value for this iSeries parameter should match the VTAM value for the Independent logical unit (LU) name.	LINE = R4082A14
Network Attribute: LCLNETID =RPC	The value for this iSeries parameter should match the VTAM Physical Unit (PU) NETID value.	NETID = RPC
Line Description attribute: LINESPEED = 9600	The value for this iSeries parameter should match the VTAM line definition parameter, SPEED.	SPEED = 9600
Line Description attribute: MAXFRAME = 521	The value for this iSeries parameter should match the VTAM value for the Line definition attribute MAXDATA.	MAXDATA = 521
Host Controller Description attribute: STNADDR	The value for this iSeries parameter should match the VTAM value for the Station address, ADDR..	ADDR = C1
Display Device Description attribute: LOCADR	The value for this iSeries parameter should match the VTAM value for the Dependent LU address.	LOCADDR = 09
<p>Note: The following iSeries system parameters are related.</p> <ul style="list-style-type: none"> The Display Device Description LCLLOCNAME parameter and the Printer Device Description LCLLOCNAME parameter values use the value set for the LCLLOCNAME Network Attribute parameter, *NETATR. The Printer Device Description CTL parameter and the Display Device Description CTL parameter specify the name of the controller description (specified in the Host Controller Description) to which they attach. The Host Controller Description value for MAXFRAME, *LINKTYPE, determines the maximum frame size to be used based on the type of line to which the controller is attached. 		

Example details: iSeries to host server connection over a token-ring line

Figure 2 on page 28 shows the iSeries system values that need to match the VTAM values when you use a token-ring line. The following table describes the relationships shown in Figure 2 on page 28 between the iSeries system values and the VTAM values. The values shown and described here are example values.

Note: The actual graphic shown in Figure 2 on page 28 depicts two controllers for the iSeries system. However, only one controller is described in the following table for ease of understanding.

Table 4. iSeries system value relationships to VTAM values

iSeries system parameter name and value	iSeries parameter value description	VTAM Licensed Program value
Network attribute: LCLLOCNAME = RCHAS722	The value for this attribute should match the VTAM Switched major Node Definition value for the Independent LU name attribute.	LU = RCHAS722
Network attribute: LCLNETID = RPC	The value for this iSeries parameter should match the VTAM value for iSeries local network ID.	NETID = RPC
Line Description attribute: ADPTADR = 4000705F4512	The value for this iSeries parameter matches the last 12 characters in the VTAM DAILNO attribute value of the PATH parameter.	DIALNO = 0104400070544512
Line Description attribute: MAXFRAME = 1994	The value for this iSeries parameter should match the VTAM physical unit (PU) value for iSeries MAXDATA.	MAXDATA = 1994
Host Controller Description attribute: LCLCHID = 0560722A	The value for this iSeries parameter is the combination of the VTAM values for iSeries Block Number and iSeries ID number.	IDBLK = 056 IDNUM = 0722A
Host Controller Description attribute: SSAP = 04	The value for this iSeries parameter matches the third and fourth characters of the VTAM DAILNO attribute value on the PATH parameter.	DIAL = 0104400070544512
Display Device Description attribute: LOCADR = 04	The value for this iSeries parameter should match the VTAM value for the LOCADDRD attribute on the SW722A04 Dependent LU address.	LOCADDR = 04
<p>Note: The following iSeries system parameters are related.</p> <ul style="list-style-type: none"> • The Display Device Description LCLLOCNAME parameter uses the value set for the LCLLOCNAME Network Attribute parameter, *NETATR. • The Display Device Description CTL parameter specifies the name of the controller description (CTLD – specified in the Host Controller Description) to which it is attached. • The Host Controller Description value for MAXFRAME, *LINKTYPE, determines the maximum frame size to be used based on the type of line to which the controller is attached. The type of line is specified in the line descriptions (LIND) parameter. 		

Example details: iSeries server DLUR support with connection to the host server

Figure 3 on page 29 shows the iSeries system values that need to match the VTAM values when you use iSeries system DLUR and VTAM. The following table describes the relationships shown in Figure 3 on page 29 between the iSeries system values and the VTAM values. The values shown and described here are example values.

Table 5. iSeries system value relationships to VTAM values

iSeries system parameter name and value	iSeries parameter value description	VTAM startup parameter values
Network Attribute: LCLNETID = APPN	The value for this iSeries parameter should match the VTAM Switched Major Node Definition physical unit (PU) value of the NETID attribute.	NETID = APPN
Line Description: ADPTADR = 400000000365	The value for this iSeries parameter matches the last 12 characters for the VTAM DAILNO attribute value of the PATH parameter.	DIALNO = 0604400000000365
Line Description: MAXFRAME = 1994	The value for this iSeries parameter matches the VTAM value for the PU attribute MAXDATA.	MAXDATA = 1994
Host Controller Description: RMTNETID = USIBMZP	The value for this iSeries parameter matches the VTAM parameter value for NETID.	NETID = USIBMZP
Host Controller Description: RMTCPNAME = R5CDRM	The value for this iSeries parameter matches the VTAM value for the SSCPNAME parameter.	SSCPNAME = R5CDRM
Host Controller Description: LCLCHID = 05613014	The value for this iSeries parameter is the combination of the VTAM values for the PU attributes IDBLK and IDNUM.	IDBLK = 056 IDNUM = 13014
Host Controller Description: SSAP = 04	The value for this iSeries parameter matches the third and fourth characters in the VTAM DIALNO attribute on the Path parameter.	DIALNO = 0604400000000365
Host Controller Description: ADPTADR = 400037000001	The value for this iSeries parameter matches the VTAM NCP Generation Token Ring Definition value for LOCADD.	LOCADD = 400037000001
<p>Note: The following iSeries system parameters are related.</p> <ul style="list-style-type: none"> The Host Controller Description LINE parameter value, *TRNLINE, defines the type of line to which the controller is connecting. The line type is determined by the line description (LIND) parameter. 		

Example details: iSeries server with APPN connection to VTAM

Figure 4 on page 30 shows the iSeries system values that need to match the VTAM values when you connect with APPN. The following table describes the relationships shown in Figure 4 on page 30 between the iSeries system values and the VTAM values. The values shown and described here are example values.

Note: The actual graphic displayed in Figure 4 on page 30 shows multiple controller description information. However, the following table only describes one set of controller description information for ease of understanding.

Table 6. iSeries system value relationships to VTAM values

iSeries system parameter name and value	iSeries parameter value description	VTAM startup parameter values
Network Attributes: LCLCPNAME = ASDLUR	The value for this iSeries parameter matches the VTAM parameter name ASDLUR.	ASDLUR
Network Attributes: LCLNETID = APPN	The value for this iSeries parameter matches the VTAM value for NETID attribute on the CDRDDLUR parameter for Cross Domain Resource Definition.	NETID = APPN
Host Controller Description: LCLCHID = 056A3271	The value for this iSeries parameter is a combination of the values for the VTAM Switched Major Node Definition parameters IDBLK and IDNUM.	IDBLK = 056 IDNUM = A3271
Host Controller Description: PRIDLUS = R5CDRM	The value for this iSeries parameter matches the VTAM value for SSCPNAME.	SSCPNAME = R5CDRM
Host Controller Description: PRIDLUS = USIBMZP	The second value for this iSeries parameter matches the VTAM value for NETID.	NETID = USIBMZP
Host Controller Description: DEPPUNAME = DA327A	The value for this iSeries parameter matches the VTAM Switched Major Node Definition physical unit (PU) name.	PU = DA327A
Display Device Description (3270 SNA Pass-Through): LOCADR = 05	The value for this iSeries parameter matches the VTAM value for the DA327A05 logical unit (LU) LOCADDR attribute.	LOCADDR = 05
Display Device Description (3270 SNA Pass-Through): DEPLOCNAME = DA327AI	The value for this iSeries parameter matches the VTAM LU name DA327A05.	LU = DA327A05
Display Device Description (Emulation): LOCADR = 0D	The hexadecimal value for this iSeries parameter matches the VTAM DA327A13 LU decimal value for the LOCADDR attribute.	LOCADDR = 13
Display Device Description (Emulation): DEPLOCNAME = DA327A13	The value for this iSeries parameter matches the name of the LU, DA327A13.	LU = DA327A13
Display Device Description (DHCF): LOCADR = 12	The hexadecimal value for this iSeries parameter matches the VTAM DA327A18 LU decimal value for the LOCADDR attribute.	LOCADDR = 18
Display Device Description (DHCF): DEPLOCNAME = DA327A18	The value for this iSeries parameter matches the name of the LU, DA327A18.	LU = DA327A18

Example details: iSeries server to iSeries server connection using X.25

Configuration parameters must be coordinated when you specify controller, device, and line descriptions for the local and remote iSeries servers. The following table describes the relationships shown in Figure 5 on page 37 between the local iSeries system values and the remote iSeries system values. The values shown and described here are example values.

Table 7. Local iSeries system value relationships to remote iSeries system values

Local iSeries system (B20) parameter name and value	iSeries parameter value description	Remote iSeries (B40) system values
CRTLINX25: NETADR = 47971013	The value for this local iSeries parameter corresponds with the value for the remote iSeries parameter CNNNBR.	CRTCTLAPPC: CNNNBR = 47971013
CRTLINX25: CHID = 056EEEEEE	The value for this local iSeries parameter corresponds with the value for the remote iSeries parameter CHID.	CRTCTLAPPC: CHID = 056EEEEEE
CRTCTLAPPC: CHID = 056FFFFFF	The value for this local iSeries parameter corresponds with the value for the remote iSeries parameter CHID.	CRTLINX25: CHID = 056FFFFFF
CRTCTLAPPC: CNNNBR = 47911140	The value for this local iSeries parameter corresponds with the value for the remote iSeries parameter NETADR.	CRTLINX25: NETADR = 47911140
CRTCTLAPPC: ROLE = *SEC	The value for this local iSeries parameter is related to the value for the remote iSeries parameter ROLE. One of the systems is the primary and the other is secondary.	CRTCTLAPPC: ROLE = *PRI
CRTDEVAPPC: RMTLOCNAME = XS400BU3	The value for this local iSeries parameter matches the value for the remote iSeries parameter RMTLOCNAME.	RMTLOCNAME = XS400BU3
CRTDEVAPPC: LCLLOCNAME = XS400BU4	The value for this local iSeries parameter matches the value for the remote iSeries parameter LCLLOCNAME.	CRTDEVAPPC: LCLLOCNAME = XS400BU4
MODD: NAME = BLANK	The value for this local iSeries parameter matches the value for the remote iSeries parameter NAME.	MODD: NAME = BLANK
<p>Note: The following iSeries system parameters are related.</p> <ul style="list-style-type: none"> • The value for the CTL parameter under CRTDEVAPPC corresponds to the value for the CTLD parameter under CRTCTLAPPC. • The value for the SWTLINLST parameter under CRTCTLAPPC corresponds to the type of line specified in the LIND parameter under CRTLINX25. 		

Example details: iSeries server to iSeries server connection using SDLC

This example describes the matching parameters between an iSeries server connecting to another iSeries server using SDLC. The following table describes the relationships shown in Figure 6 on page 38 between the local iSeries system values and the remote iSeries system values. The values shown and described here are example values.

Table 8. Local iSeries system value relationships to remote iSeries system values

Local iSeries system (EC) parameter name and value	iSeries attribute value description	Remote iSeries (FSC) system values
CRTLNSDLC: ROLE = *SEC	The value for this local iSeries parameter is related to the value for the remote iSeries parameter ROLE. One of the systems must be primary and the other must be secondary.	CRTLNSDLC: ROLE = *PRI
CRTLNSDLC: CHID = 05600401	The value for this local iSeries parameter matches the value for the remote iSeries parameter CHID.	CRTCTLAPPC: CHID = 05600401
CRTCTLAPPC: CHID = 05600400	The value for this local iSeries parameter matches the value for the remote iSeries parameter CHID.	CRTLNSDLC: CHID = 05600400
CRTCTLAPPC: ROLE = *PRI	The value for this local iSeries parameter is related to the value for the remote iSeries parameter ROLE. One of the systems must be primary and the other must be secondary.	CRTCTLAPPC: ROLE = *SEC
CRTCTLAPPC: STNADR = C1	The value for this local iSeries parameter matches the value for the remote iSeries parameter STNADR.	CRTCTLAPPC: STNADR = C1
CRTDEVAPPC: RMTLOCNAME = ISERIESBU3	The value for this local iSeries parameter matches the value for the remote iSeries parameter LCLLOCNAME.	CRTDEVAPPC: LCLLOCNAME = ISERIESBU3
CRTDEVAPPC: LCLLOCNAME = ISERIESBU1	The value for this local iSeries parameter matches the value for the remote iSeries parameter RMTLOCNAME.	CRTDEVAPPC: RMTLOCNAME = ISERIESBU1
CRTDEVAPPC: MODE = BLANK	The value for this local iSeries parameter matches the value for the remote iSeries parameter MODE.	CRTDEVAPPC: MODE = BLANK
<p>Note: The following iSeries system parameters are related.</p> <ul style="list-style-type: none"> • The value for the CTL parameter under CRTDEVAPPC corresponds to the value for the CTLD parameter under CRTCTLAPPC. • The value for the LINE parameter under CRTCTLAPPC corresponds to the type of line specified in the LIND parameter under CRTLNSDLC. 		

Example details: iSeries server to iSeries server connection using one-way automatic dialing

This example shows the matching parameters between an iSeries server connecting to another iSeries server using the one-way automatic-dial function. The following table describes the relationships shown in Figure 7 on page 39 between the local iSeries system values and the remote iSeries values. The values shown and described here are example values.

Table 9. Local iSeries system value relationships to remote iSeries system values

Local iSeries system (B20) parameter name and value	iSeries parameter value description	Remote iSeries (B40) system values
Line Description: ROLE = *NEG	The value for this local iSeries parameter matches the value for the remote iSeries parameter ROLE.	Line Description: ROLE = *NEG

Table 9. Local iSeries system value relationships to remote iSeries system values (continued)

Local iSeries system (B20) parameter name and value	iSeries parameter value description	Remote iSeries (B40) system values
Line Description: CNN = *SWTPP	The value for this local iSeries parameter matches the value for the remote iSeries parameter CNN.	Line Description: CNN = *SWTPP
Line Description: CHID = 056FFFFF	The value for this local iSeries parameter matches the value for the remote iSeries parameter SWTLINLST.	Controller Description: CHID = 056FFFFF
Line Description: LINESPEED = 2400	The value for this local iSeries parameter matches the value for the remote iSeries parameter LINESPEED.	Line Description: LINESPEED
Line Description: SWTCNN = *DIAL	The value for this local iSeries parameter is related to the value for the remote iSeries parameter SWTCNN. One of the systems values must be set to *DAIL and the other to *ANS.	Line Description: SWTCNN = *ANS
Line Description: AUTOANS = *NO	The value for this local iSeries parameter is related to the value for the remote iSeries parameter AUTOANS.	Line Description: AUTOANS = *YES
Line Description: AUTODIAL = *YES	The value for this local iSeries parameter is related to the value for the remote iSeries parameter AUTODIAL.	Line Description: AUTODIAL = *NO
Line Description: STNADR = B1	The value for this local iSeries parameter matches the value for the remote iSeries parameter STNADR.	Line Description: STNADR = B1
Controller Description: LINKTYPE = *SDLC	The value for this local iSeries parameter matches the value for the remote iSeries parameter LINKTYPE.	Controller Description: LINKTYPE = *SDLC
Controller Description: SWITCHED = *YES	The value for this local iSeries parameter matches the value for the remote iSeries parameter SWITCHED.	Controller Description: SWITCHED = *YES
Controller Description: APPN = *NO	The value for this local iSeries parameter matches the value for the remote iSeries parameter APPN.	Controller Description: APPN = *NO
Controller Description: HID = 056EEEEEE	The value for this local iSeries parameter matches the value for the remote iSeries parameter CHID.	Line Description: CHID = 056EEEEEE
Controller Description: ROLE = *NEG	The value for this local iSeries parameter matches the value for the remote iSeries parameter ROLE.	Controller Description: ROLE = *NEG
Controller Description: STNADR = B1	The value for this local iSeries parameter matches the value for the remote iSeries parameter STNADR.	Controller Description: STNADR = B1
Device Description: RMTLOCNAME = AD400BU3	The value for this local iSeries parameter matches the value for the remote iSeries parameter LCLLOCNAME.	Device Description: LCLLOCNAME = AD400BU3

Table 9. Local iSeries system value relationships to remote iSeries system values (continued)

Local iSeries system (B20) parameter name and value	iSeries parameter value description	Remote iSeries (B40) system values
Device Description: LCLLOCNAME = AD400BU4	The value for this local iSeries parameter matches the value for the remote iSeries parameter RMTLOCNAME.	Device Description: RMTLOCNAME = AD400BU4
Device Description: MODE = BLANK	The value for this local iSeries parameter matches the value for the remote iSeries parameter MODE.	Device Description: MODE = BLANK
Device Description: APPN = *NO	The value for this local iSeries parameter matches the value for the remote iSeries parameter APPN.	Device Description: APPN = *NO
<p>Note: The following iSeries system parameters are related.</p> <ul style="list-style-type: none"> • The value for the CTL parameter under Device Description corresponds to the value for the CTLD parameter under Controller Description for both iSeries systems. • The value for the SWTLINLST parameter under Controller Description corresponds to the value for the LIND parameter under Line Description for both iSeries systems. 		

Example details: iSeries server to iSeries server connection using Enterprise Extender (HPRIP)

This example shows the matching parameters between an iSeries server connecting to another iSeries server using Enterprise Extender. The following table describes the relationships shown in Figure 8 on page 40 between the local iSeries system values and the remote iSeries values. The values shown and described here are example values.

Table 10. Local iSeries system value relationships to remote iSeries system values

Local iSeries system (ALPHA) parameter name and value	iSeries parameter value description	Remote iSeries (BETA) system values
Controller description: CTLD = BETACTL	The value for this local iSeries parameter matches the name for the remote iSeries name, and vice versa.	Controller description: CTLD = ALPHACTL
Controller description: LINKTYPE = *HPRIP	The values for iSeries parameter LINKTYPE must be *HPRIP on both systems to use Enterprise Extender.	Controller description: LINKTYPE = *HPRIP
Controller description: RMTINTNETA = 9.18.34.223	The value for this local iSeries parameter matches the value for the remote iSeries IP address, and vice versa.	Controller description: RMTINTNETA = 9.18.33.40
Controller description: RMTCPNAME = BETA	The value for this local iSeries parameter matches the value for the remote iSeries CP name, and vice versa.	Controller description: RMTCPNAME = ALPHA
Controller description: RMTNETID = ALPHA	The value for this local iSeries parameter matches the value for the remote iSeries network ID if they are in the same network.	Controller description: RMTNETID = ALPHA
Controller description: DSAP = 04	The value for this local iSeries parameter matches the value for the remote iSeries parameter SSAP.	Controller description: DSAP = 04

Table 10. Local iSeries system value relationships to remote iSeries system values (continued)

Local iSeries system (ALPHA) parameter name and value	iSeries parameter value description	Remote iSeries (BETA) system values
Controller description: SSAP = 04	The value for this local iSeries parameter matches the value for the remote iSeries parameter DSAP.	Controller description: SSAP = 04
<p>Note: The following fields are added for Enterprise Extender:</p> <ul style="list-style-type: none"> • RMTINTNETA : Remote internet address. An IPv4 internet address in the format of xxx.xxx.xxx.xxx.. • LCLINTNETA: Local internet address. An IPv4 internet address in the format of xxx.xxx.xxx.xxx. If the value of *SYS is not selected, the output traffic for this controller will go through the defined IP address. Otherwise, the output traffic will use the TCP/IP routing tables to determine the best interface to send the data. • LDLCTIMR: LDLC timers. These will control the timers required by the LDLC protocol to retry a send, the number of retries, and how often a test frame will be sent to the remote. A test frame will only be sent to the remote system if data hasn't been received from the remote system during that time period. • LDLCLNKSPD: This gives the APPN value of link speed. Possible values are: *CAMPUS (4 Mbps), *WAN (56 kbps), 10 Mbps, 4 Mbps, 16 Mbps, 100 Mbps, *MAX (greater than 100Mbps), and *MIN (less than 1200 bps). APPN uses this value to calculate the weight of this particular link when calculating the path of any request. • LDLCTMSGRP: The rest of the APPN values are used to calculate the link weight: cost per connection, cost per byte, link security, and propagation delay. All of these values are used by APPN to calculate the best route to a remote host. These values only appear when the LDLCLNKSPD parameter has a value other than the default. 		

Example details: iSeries server connection to a 3174 control unit

The following table describes the iSeries system parameters and 3174 parameters that need to match when you use token ring. The following table describes the relationships shown in Figure 9 on page 53 between the iSeries system values and the 3174 control unit values. The values shown and described here are example values.

Table 11. iSeries system value relationships to 3174 control unit values

iSeries system parameter name and value	iSeries parameter value description	3174 control unit values
Line Description CRTLINTRN: ADPTADR = 4000710DE300	The value for this iSeries parameter matches the value for the 3174 control unit parameter 107.	107 – 4000710DE300 (Token ring network address of the gateway)
Controller Description CRTCTLRWS: LINKTYPE = *LAN	The value for this iSeries parameter corresponds to the value for the 3174 control unit parameter 101.	101 – 7 (Token ring network)
Controller Description CRTCTLRWS: ADPTADR = 400031740004	The value for this iSeries parameter matches the value for the 3174 control unit parameter 106.	107 – 4000 3174 0004 (Token ring network address of the 3174 control unit)

Example details: iSeries server connection to a finance network

The detailed information corresponding to Figure 10 on page 58 can be found in Table 1 on page 56. The prompt values for both the FBSS controllers and the iSeries server are discussed in the table, providing information on how the settings for both are related.

Example details: iSeries server connection to 4690 LU0 over token-ring network

The following table describes the relationships shown in Figure 11 on page 67 between the iSeries system values and the 4690 controller values. The values shown and described here are example values.

Table 12. iSeries system value relationships to 4690 controller values

iSeries system parameter name and value	iSeries parameter value description	4690 controller values
Line Description (TRLINE): ADPTADR = 40000010C68C	The value for this iSeries parameter matches the value for the 4690 controller parameter Remote Node Address.	Link Definition (RCHASXXX): Remote Node Address = 40000010C68C
Retail Controller Description (R4690CC): ADPTADR = 4000004690CC	The value for this iSeries parameter matches the value for the 4690 controller parameter Local Node Address.	Line Definition (ADXTOKEN): Local Node Address = 4000004690CC
Retail Controller Description (R4690CC): CHID = 04D00001	The value for this iSeries parameter matches the value for the 4690 controller parameter change ID.	Link Definition (RCHASXXX): change ID = 04D00001
Retail Controller Description (R4690CC): SSCPID = 05000000000	The value for this iSeries parameter matches the value for the 4690 controller parameter SSCPID.	Link Definition (RCHASXXX): SSCPID = 05000000000
Retail Device Description (R4690HCP): LOCADR = 01	The value for this iSeries parameter matches the value for the 4690 controller parameter Session Address.	SNA Session Group (LU0GRP): Session Address = 01
Retail Device Description (R4690RCM): LOCADR = 02	The value for this iSeries parameter matches the value for the 4690 controller parameter Session Address.	SNA Session Group (LU0GRP): Session Address = 02

Example details: iSeries server connection to 4690 peer over token-ring network

The following table describes the relationships shown in Figure 12 on page 68 between the iSeries system values and the 4690 controller values. The values shown and described here are example values.

Table 13. iSeries system value relationships to 4690 controller values

iSeries system parameter name and value	iSeries parameter value description	4690 controller values
Token Ring Line Description (TRLINE): ADPTADR = 40000010C68C	The value for this iSeries parameter matches the value for the 4690 controller parameter Remote Node Address.	Link Definition (RCHASXXX): Remote Node Address = 40000010C68C
APPC Controller Description (R4690CC): ADPTADR = 4000004690CC	The value for this iSeries parameter matches the value for the 4690 controller parameter Local Node Address.	Line Definition (ADXTOKEN): Local Node Address = 4000004690CC
APPC Device Description (R4690RCP): RMTLOCNAM = R4690CC	The value for this iSeries parameter corresponds to the value for the 4690 controller parameter Local Logical Unit (LU) Name.	Local LU Definition (R4690CC): Local LU Name = APPN.R4690CC
APPC Device Description (R4690RCP): LOCLOCNAM = RCHASXXX	The value for this iSeries parameter corresponds to the value for the 4690 controller parameter Partner LU.	Partner LU Definition (R4690CC): Partner LU = APPN.RCHASXXX
APPC Device Description (R4690RCP): LOCADR = 00	The value for this iSeries parameter matches the value for the 4690 controller parameter LU Address.	Local LU Definition (R4690CC): LU Address = 00

Table 13. iSeries system value relationships to 4690 controller values (continued)

iSeries system parameter name and value	iSeries parameter value description	4690 controller values
APPC Device Description (R4690RCP): MODE = MODETRN	The value for this iSeries parameter corresponds to the value for the 4690 controller Mode Definition.	Mode Definition (MODETRN)
Mode Description (MODETRN): MAXSSN = 4	The value for this iSeries parameter matches the value for the 4690 controller parameter Session Limit.	Mode Definition (MODETRN): Session Limti = 4
Communications Side Information (R4690CC): TNSPGM = adxtest	The value for this iSeries parameter matches the value for the 4690 controller parameter	Remotely Attachable TP Name (ADXTEST): Remotely Attachable Local TP Name = adxtest

Appendix. Notices

This information was developed for products and services offered in the U.S.A.

IBM may not offer the products, services, or features discussed in this document in other countries. Consult your local IBM representative for information on the products and services currently available in your area. Any reference to an IBM product, program, or service is not intended to state or imply that only that IBM product, program, or service may be used. Any functionally equivalent product, program, or service that does not infringe any IBM intellectual property right may be used instead. However, it is the user's responsibility to evaluate and verify the operation of any non-IBM product, program, or service.

IBM may have patents or pending patent applications covering subject matter described in this document. The furnishing of this document does not grant you any license to these patents. You can send license inquiries, in writing, to:

IBM Director of Licensing
IBM Corporation
North Castle Drive
Armonk, NY 10504-1785
U.S.A.

For license inquiries regarding double-byte (DBCS) information, contact the IBM Intellectual Property Department in your country or send inquiries, in writing, to:

IBM World Trade Asia Corporation
Licensing
2-31 Roppongi 3-chome, Minato-ku
Tokyo 106-0032, Japan

The following paragraph does not apply to the United Kingdom or any other country where such provisions are inconsistent with local law: INTERNATIONAL BUSINESS MACHINES CORPORATION PROVIDES THIS PUBLICATION "AS IS" WITHOUT WARRANTY OF ANY KIND, EITHER EXPRESS OR IMPLIED, INCLUDING, BUT NOT LIMITED TO, THE IMPLIED WARRANTIES OF NON-INFRINGEMENT, MERCHANTABILITY OR FITNESS FOR A PARTICULAR PURPOSE. Some states do not allow disclaimer of express or implied warranties in certain transactions, therefore, this statement may not apply to you.

This information could include technical inaccuracies or typographical errors. Changes are periodically made to the information herein; these changes will be incorporated in new editions of the publication. IBM may make improvements and/or changes in the product(s) and/or the program(s) described in this publication at any time without notice.

Any references in this information to non-IBM Web sites are provided for convenience only and do not in any manner serve as an endorsement of those Web sites. The materials at those Web sites are not part of the materials for this IBM product and use of those Web sites is at your own risk.

IBM may use or distribute any of the information you supply in any way it believes appropriate without incurring any obligation to you.

Licensees of this program who wish to have information about it for the purpose of enabling: (i) the exchange of information between independently created programs and other programs (including this one) and (ii) the mutual use of the information which has been exchanged, should contact:

IBM Corporation

Software Interoperability Coordinator, Department YBWA
3605 Highway 52 N
Rochester, MN 55901
U.S.A.

Such information may be available, subject to appropriate terms and conditions, including in some cases, payment of a fee.

The licensed program described in this information and all licensed material available for it are provided by IBM under terms of the IBM Customer Agreement, IBM International Program License Agreement, IBM License Agreement for Machine Code, or any equivalent agreement between us.

Any performance data contained herein was determined in a controlled environment. Therefore, the results obtained in other operating environments may vary significantly. Some measurements may have been made on development-level systems and there is no guarantee that these measurements will be the same on generally available systems. Furthermore, some measurements may have been estimated through extrapolation. Actual results may vary. Users of this document should verify the applicable data for their specific environment.

Information concerning non-IBM products was obtained from the suppliers of those products, their published announcements or other publicly available sources. IBM has not tested those products and cannot confirm the accuracy of performance, compatibility or any other claims related to non-IBM products. Questions on the capabilities of non-IBM products should be addressed to the suppliers of those products.

All statements regarding IBM's future direction or intent are subject to change or withdrawal without notice, and represent goals and objectives only.

All IBM prices shown are IBM's suggested retail prices, are current and are subject to change without notice. Dealer prices may vary.

This information is for planning purposes only. The information herein is subject to change before the products described become available.

This information contains examples of data and reports used in daily business operations. To illustrate them as completely as possible, the examples include the names of individuals, companies, brands, and products. All of these names are fictitious and any similarity to the names and addresses used by an actual business enterprise is entirely coincidental.

COPYRIGHT LICENSE:

This information contains sample application programs in source language, which illustrate programming techniques on various operating platforms. You may copy, modify, and distribute these sample programs in any form without payment to IBM, for the purposes of developing, using, marketing or distributing application programs conforming to the application programming interface for the operating platform for which the sample programs are written. These examples have not been thoroughly tested under all conditions. IBM, therefore, cannot guarantee or imply reliability, serviceability, or function of these programs.

Each copy or any portion of these sample programs or any derivative work, must include a copyright notice as follows:

© (your company name) (year). Portions of this code are derived from IBM Corp. Sample Programs. © Copyright IBM Corp. _enter the year or years_. All rights reserved.

If you are viewing this information softcopy, the photographs and color illustrations may not appear.

Trademarks

The following terms are trademarks of International Business Machines Corporation in the United States, other countries, or both:

Advanced-Peer-to-Peer Networking
AnyNet
AS/400
C/400
CICS
CICS/400
Cobol/400
Distributed Relational Database Architecture
DRDA
i5/OS
IBM
iSeries
Language Environment
MVS
RPG/400
System/36
System/38
System/370
System/390
VTAM
zSeries

Microsoft[®], Windows, Windows NT[®], and the Windows logo are trademarks of Microsoft Corporation in the United States, other countries, or both.

Other company, product, and service names may be trademarks or service marks of others.

Terms and conditions

Permissions for the use of these publications is granted subject to the following terms and conditions.

Personal Use: You may reproduce these publications for your personal, noncommercial use provided that all proprietary notices are preserved. You may not distribute, display or make derivative works of these publications, or any portion thereof, without the express consent of IBM.

Commercial Use: You may reproduce, distribute and display these publications solely within your enterprise provided that all proprietary notices are preserved. You may not make derivative works of these publications, or reproduce, distribute or display these publications or any portion thereof outside your enterprise, without the express consent of IBM.

Except as expressly granted in this permission, no other permissions, licenses or rights are granted, either express or implied, to the publications or any information, data, software or other intellectual property contained therein.

IBM reserves the right to withdraw the permissions granted herein whenever, in its discretion, the use of the publications is detrimental to its interest or, as determined by IBM, the above instructions are not being properly followed.

You may not download, export or re-export this information except in full compliance with all applicable laws and regulations, including all United States export laws and regulations.

IBM MAKES NO GUARANTEE ABOUT THE CONTENT OF THESE PUBLICATIONS. THE PUBLICATIONS ARE PROVIDED "AS-IS" AND WITHOUT WARRANTY OF ANY KIND, EITHER EXPRESSED OR IMPLIED, INCLUDING BUT NOT LIMITED TO IMPLIED WARRANTIES OF MERCHANTABILITY, NON-INFRINGEMENT, AND FITNESS FOR A PARTICULAR PURPOSE.



Printed in USA