



IBM Systems - iSeries  
Troubleshooting

*Version 5 Release 4*







IBM Systems - iSeries  
Troubleshooting

*Version 5 Release 4*

**Note**

Before using this information and the product it supports, read the information in "Notices," on page 67.

**Ninth Edition (February 2006)**

This edition applies to version 5, release 4, modification 0 of IBM i5/OS (product number 5722-SS1) and to all subsequent releases and modifications until otherwise indicated in new editions. This version does not run on all reduced instruction set computer (RISC) models nor does it run on CISC models.

© Copyright International Business Machines Corporation 1998, 2006. All rights reserved.

US Government Users Restricted Rights – Use, duplication or disclosure restricted by GSA ADP Schedule Contract with IBM Corp.

---

# Contents

|   |          |
|---|----------|
| <b>Troubleshooting</b> . . . . .                          | <b>1</b> |
| What's new for V5R4 . . . . .                             | 1        |
| Printable PDF . . . . .                                   | 1        |
| How your server manages problems . . . . .                | 2        |
| Detect problems . . . . .                                 | 2        |
| System reference codes . . . . .                          | 2        |
| Messages . . . . .  | 3        |
| Message queues . . . . .                                  | 4        |
| Logs . . . . .  | 4        |
| Watch for event function . . . . .                        | 4        |
| Analyze and handle problems . . . . .                     | 8        |
| Problem analysis procedures . . . . .                     | 8        |
| System reference code list . . . . .                      | 17       |
| Perform a main storage dump . . . . .                     | 25       |
| CL commands . . . . .                                     | 28       |
| Problem-handling menus . . . . .                          | 28       |
| Use authorized program analysis reports . . . . .         | 29       |
| Report problems: Overview . . . . .                       | 31       |
| Gather information with the problem summary form. . . . . | 31       |
| Contact IBM support . . . . .                             | 35       |

|  |    |
|--|----|
| Report problems detected by the system. . . . .  | 36 |
| Track problems . . . . .   | 37 |
| Reference information . . . . .  | 39 |
| Details: Messages . . . . .  | 39 |
| Details: Message queues . . . . .  | 45 |
| Details: Logs . . . . .  | 49 |
| Details: CL commands. . . . .  | 54 |
| Details: Problem-handling menus . . . . .  | 59 |
| Details: Authorized program analysis reports . . . . .   | 61 |
| Determine the primary or alternative consoles. . . . .   | 62 |
| Replace the battery power unit on Models 5xx and expansion units FC 507x and FC 508x . . . . . | 63 |
| Related information for troubleshooting . . . . .  | 65 |
| Code license and disclaimer information. . . . .   | 65 |

|   |           |
|---|-----------|
| <b>Appendix. Notices</b> . . . . .          | <b>67</b> |
| Programming Interface Information . . . . . | 68        |
| Trademarks . . . . .                        | 69        |
| Terms and conditions . . . . .              | 69        |



---

## Troubleshooting

Use the Troubleshooting topic to help you understand, isolate, and resolve problems that you are having with your IBM® eServer™ iSeries™ server and products.

Sometimes you will be able to resolve a problem on your own, other times you will need to gather information to help the service technicians resolve your problem in a timely manner.

**Note:** By using the code examples, you agree to the terms of the “Code license and disclaimer information” on page 65.

**Note:** IBM System i5 is the next generation of iSeries. The documentation in the iSeries Information Center may refer to System i5 as iSeries.



---

## What’s new for V5R4

- | For V5R4, you can use the Watch for event function to help detect and react to problems.
- | The watch for event function enhances the ability to detect and react to problems represented by specific messages or Licensed Internal Code log entries.

### How to see what’s new or changed

To help you see where technical changes have been made, this information uses:

- The  image to mark where new or changed information begins.
- The  image to mark where new or changed information ends.

To find other information about what’s new or changed this release, see the Memo to users.

---

## Printable PDF

Use this to view and print a PDF of this information.

To view or download the PDF version of this document, select Troubleshooting (about 700 KB).

### Saving PDF files

To save a PDF on your workstation for viewing or printing:

1. Right-click the PDF in your browser (right-click the link above).
- | 2. Click the option that saves the PDF locally.
3. Navigate to the directory in which you want to save the PDF.
4. Click **Save**.

### Downloading Adobe Reader

- | You need Adobe Reader installed on your system to view or print these PDFs. You can download a free
- | copy from the Adobe Web site ([www.adobe.com/products/acrobat/readstep.html](http://www.adobe.com/products/acrobat/readstep.html)) .

---

## How your server manages problems

Use this information to find out how your server manages problems.

The problem-analysis functions that your server provides allow you to manage both system-detected and user-defined problems. Your server provides functions for problem analysis, problem logging and tracking, problem reporting, and problem correction. The structured problem management server helps you and your service provider quickly and accurately manage problems as they occur on the server.

The following example illustrates the flow when managing a problem:

1. The server detects a hardware error.
2. An error notification is sent to the server.
3. A problem record is created with configuration information, a system reference code, the name of the reporting device, and other information.
4. The error is recorded in the system error log.
5. A message is sent to the system operator's message queue.
6. Problem analysis starts with the message.

The results of problem analysis are automatically stored, along with the collected problem information. At this point, you can report the problem to your service provider.

Various tools are available to help you manage the problems on your server.

### **Related concepts**

"Analyze and handle problems" on page 8

Use this information to further analyze and handle problems, including a start problem analysis procedure that guides you through resolving the problem.

"Report problems: Overview" on page 31

Use this information to learn what information you should gather about your problem, how to report and track problems, and how to send a service request.

"Detect problems"

Use this information to find out how you can detect problems.

---

## Detect problems

Use this information to find out how you can detect problems.

There are several ways you can detect that problems have occurred on your system. Most of the time, you will receive a message or system reference code (SRC). You can also use message queues and logs to gather more information.

### **Related concepts**

"How your server manages problems"

Use this information to find out how your server manages problems.

## System reference codes

A system reference code (SRC) is a set of eight characters that identifies the name of the system component that detects the error codes and the reference code that describes the condition.

The first 4 characters of the SRC indicate the type of error. The last 4 characters give additional information. In this document, when xxxx is shown as the last 4 characters of the SRC, each x can be any number 0 through 9, or letter A through F.



When the system detects a problem, it displays an SRC on the system control panel. When you go through the following problem-analysis procedure, you will find out how to record the SRC on paper. The information gained from the SRC can help the hardware service provider better understand the problem and how to fix it. Also, you might be able to find the SRC in the system reference code list to resolve it further on your own.

## Examples: SRCs

The following examples show SRCs that might occur as the result of an abnormal restart:

### Example 1:

Any B900 xxxx SRC (where xxxx is any number or letter) during the start of the operating system phase of restart.

### Example 2:

A Power Down System (PWRDWN SYS) command that was not completed, ending with an SRC of B900 3F10.

## Error codes

An error code is a group of characters or digits displayed on the console. Error codes are displayed in an error message, recorded in a problem log entry, or shown on the system control panel.

Error codes indicate that a hardware or software error condition has occurred in the system.

The system attention light is turned on when the system detects a hardware error it cannot correct. An error might result in the loss or corruption of data.

The error code recorded in the problem log is used to report errors and to perform problem analysis and resolution. Some error codes have the system automatically collect associated data that is used to diagnose the problem.

Some error codes require you to restart the system for recovery, whereas others might be handled and automatically recovered by the system.

### Related tasks

“System reference code list” on page 17

Use the tables below to locate the System Reference Code (SRC) that you have displayed. In the table, xxxx can be any number 0 through 9 or letter A through F.

## Messages

Messages are communications that are sent from one person or program to another.

Whether you are a system operator or user, you can communicate on your server by using messages. The system operator and users can communicate by sending and receiving messages. System programs use messages to communicate system conditions.

Your server sends informational and inquiry messages that provide you with important system information. Inquiry messages require you to respond. Informational messages allow you to keep track of system activities, jobs, users, and errors. Because messages provide information about your system, you should know how to handle messages when detecting and correcting problems.

You can display, send, respond to, remove, and print messages.

### Related concepts

“Details: Messages” on page 39

Use this topic to find out details on the types of messages and the ways to manage messages.

## Message queues

A message queue is like a mail box for messages.

Your server has several message queues that hold messages that provide helpful information when detecting and reporting problems. Understanding the location of history files, error messages, and system messages can help you solve problems because they contain important system information.

You can create, change, and print message queues.

### Related concepts

“Details: Message queues” on page 45

Use this topic to find out details on the different types of message queues and the several ways to manage message queues.

## Logs

The i5/OS™ licensed program records certain kinds of events and messages for use in diagnosing problems.

A log is a special kind of database file that is used by the system to record this information. There are three types of logs:

- **Job logs:** Any job that runs on your server has a corresponding job log which records the job’s status and activities.
- **History logs:** Contain information about the operation of the system and the system status.
- **Problem logs:** Are a useful tool for coordinating and tracking all your problem management operations.

### Related concepts

“Details: Logs” on page 49

Use this topic to find out details on the different log types.

Job logs and communication problems

## Watch for event function

| The watch for event function enhances your ability to detect and react to problems represented by  
| specific messages or Licensed Internal Code log entries. The watch for event function notifies you when  
| the specified event (message or Licensed Internal Code log entry) occurs, and then calls the specified exit  
| program to take the desired action.

### Use the watch for event function

| Use the corresponding commands to set up and use the watch for event function.

## Start Watch (STRWCH) command

The Start Watch (STRWCH) command starts a watch session and notifies you when the specified message or Licensed Internal Code log entry occurs. When the watched for message is added to the specified message queue or log, or the watched for log entry is added, the exit program specified in the Watch program (WCHPGM) parameter is called.

| When watching for messages, you must specify the message queue or job log where you expect the  
| message to be sent. You can narrow the search by specifying a text string to be compared against the  
| message data, the From program or the To program of the watched for message.

| When watching for Licensed Internal Code log entries, you must specify the Licensed Internal Code log major and minor codes. \*ALL and wildcards (?) are accepted. You can narrow the search by specifying a text string to be compared against several of the Licensed Internal Code log fields of the watched for log entry. Use the Watch for Licensed Internal Code log entry (WCHLICLOG) parameter on the STRWCH command.

### | **Work with Watches (WRKWCH) command**

| The Work with Watches (WRKWCH) command is used to show a panel with a list of active watches on the system.

### | **End Watch (ENDWCH) command**

| The End Watch (ENDWCH) command is used to end a watch session.

### | **Start Watch (QSCSWCH) and End Watch (QSCEWCH) APIs**

| The Start Watch (QSCSWCH) and End Watch (QSCEWCH) application programming interfaces (APIs) have a very similar usage to the STRWCH and ENDWCH commands.

### | **Use the watch for event function with trace commands**

| Watch support enhances the trace functions by automatically monitoring and ending traces when certain predetermined criteria are met. This prevents the loss of valuable trace data and reduces the amount of time that you need to spend monitoring traces. For more information, see Advanced trace function: Watch support.

#### **Related information**

Exit Program for Watch for Event

Start Watch (STRWCH)

### **Scenario: Use the watch for event function with an exit program**

To learn how to use the watch for event function with an exit program, read this scenario.

| You have a MYCLNUP program that you run whenever you want to free up storage space on your system. You usually run this program when message CPF0907 (Serious storage condition might exist) is sent to the system operator message queue (QSYSOPR).

You use the watch for event function to automatically run your clean up program when the amount of available storage in the system auxiliary storage pool has reached the threshold value. Your user exit program also performs some special actions when the available storage is less than 5 percent.

| To run MYCLNUP when message CPF0907 enters the specified message queue, follow these steps:

- | 1. Start a watch session:
  - | a. At the command line, type STRWCH and press F4.
  - | b. For the **Session ID** prompt, specify a meaningful session identifier, such as mycleanup.
  - | c. For the **Watch program parameter**, specify MYWCHPGM, and type MYLIB for the **Watch program Library** prompt. MYWCHPGM is the exit program to be called when the watched for event occurs. See "Exit program for watch for event scenario" on page 6.
  - | d. For the **Watch for message, Message identifier** prompt, type CPF0907.
  - | e. For the **Watched message queue, Message queue** prompt, type \*SYSOPR. This ensures that your watch exit program is called when the CPF0907 message is sent to the system operator message queue.
- | 2. Verify that the watch session started:

- a. At the command line, type WRKWCH and press F4.
  - b. For the **Watch** prompt, type \*STRWCH.
  - c. Check to see that the MYCLEANUP session is listed under the STRWCH type.
- After the CPF0907 message is sent to the system operator message queue, the MYWCHPGM program in MYLIB library is called. This program can call your MYCLNUP program and do any other function you need by customizing the exit program.
3. When you do not need your watch session anymore, end it:
    - a. At the command line, type ENDWCH and press F4.
    - b. For the **Session ID** prompt, specify mycleanup.
  4. Verify that the watch session ended:
    - a. At the command line, type WRKWCH and press F4.
    - b. For the **Watch** prompt, type \*STRWCH.
    - c. Check to see that the MYCLEANUP session is not listed anymore.

**Note:** You can also type DSPMSG MSGQ(\*SYSOPR) to verify that the watch session has ended. You should see the CPI3999 message, which indicates that the MYCLEANUP watch session was ended because of reason code 08. Reason code 08 indicates that the End Watch (ENDWCH) command or End Watch (QSCEWCH) API was issued.

## Exit program for watch for event scenario

The code in this topic is an example for a watch for event exit program. It is written in C.

Use this exit program as a starting point to help you create your own watch for event exit program. You can modify the code to allow the program to perform additional functions.

**Note:** By using the code examples, you agree to the terms of the “Code license and disclaimer information” on page 65.

```

| /*****
| ** file = mywchpgm.c
| **
| ** Example of an Exit Program for Watch for Event.
| **
| ** This program will be called by the watch for event support when CPF0907
| ** message is sent to QSYSOPR.
| **
| ** The program will call a clean up program to free up system storage and,
| ** if the available storage is less than 5%, the program will perform some
| ** more actions (not defined)
| **
| *****/
| #include <decimal.h>
| #include <stdio.h>
| #include <string.h>
| #include <stdlib.h>
| #include <except.h> /* _INTRPT_Hndlr_Parms_T is typedefed */
| #include <escwcht.h> /* Include for Watch Exit Program packaged in */
| /* QSYSINC/H Source Physical File */
|
| /***** Prototypes *****/
| void UNEXPECTED_HDLER (_INTRPT_Hndlr_Parms_T *errmsg);
|
| /* Declare variables to receive parameters */
| char watch_option_setting[10],
|      session_ID[10],
|      * error_detected_ptr;
|
| typedef struct {
|     Qsc_Watch_For_Msg_t msg_data;
|     char VarData[8776]; /* variable length data */

```

```

| } MsgFullData_t;
|
| MsgFullData_t * MsgFullData;
|
| int main (int argc, char *argv[])
| {
|
|     char * cAvailStorage[4];
|     decimal(7,4) dAvailStorage;
|
|     /* Variables to call a command */
|     int rc;
|     char cmdtorun[128];
|     #define CALL_MYCLNUP "CALL PGM(MYLIB/MYCLNUP)"
|
|     /*****
|     /* Turn exception monitor on. */
|     /*****
|     #pragma exception_handler (UNEXPECTED_HDLER, 0, 0, _C2_MH_ESCAPE)
|
|     memcpy(watch_option_setting,argv[1],10);
|     memcpy(session_ID,argv[2],10);
|     error_detected_ptr = argv[3];
|     MsgFullData = (MsgFullData_t *) argv[4];
|
|     /* Verify if the exit program was called because a watched message */
|     /* occurred. This verification is useful if you have a watch */
|     /* session waiting for a message event and for a LICLog event */
|     if (memcmp(watch_option_setting,"*MSGID ",10)==0) {
|
|         /* Verify if the message id that occurred is CPF0907 */
|         /* This verification is useful if you are watching for more than */
|         /* one message in the same watch session */
|         if (memcmp(MsgFullData->msg_data.Message_ID,"CPF0907",7)==0) {
|
|             /* Call clean up program to free up space */
|             strcpy(cmdtorun,CALL_MYCLNUP);
|             rc = system(cmdtorun);
|
|         if (rc == 0) {
|             /* Determine if the available storage space is less than 5% */
|             /* to do some extra processing */
|
|             if (MsgFullData->msg_data.Length_Of_Replacement_Data > 0) {
|
|                 /* The remaining storage comes in the 4th field data in the */
|                 /* message replacement variable. See CPF0907 message */
|                 /* description for a better understanding */
|                 memcpy(cAvailStorage,
|                     (char *) (argv[4] +
|                         MsgFullData->msg_data.Offset_Replacement_Data + 66),
|                     4);
|
|                 dAvailStorage = *(decimal(7,4) *) cAvailStorage;
|
|                 if (dAvailStorage <= 5.00) {
|                     /* Do some extra processing */
|                 }
|             }
|         }
|     }
|     else { /* Error on clean up program */
|         UNEXPECTED_HDLER(NULL); /* Return error and exit */
|     }
|     }
|     else {
|         /* Add code in case you are expecting any other message id */
|     }
| }

```

```

|     }
|
|     /* Verify if the exit program was called because a LIC Log occurred */
|     else if (memcmp/watch_option_setting,"*LICLOG  ",10)==0) {
|         /* Not needed for this watch session */
|     }
|
|     memcpy(error_detected_ptr,"          ",10); /* No error detected by
|                                                watch exit program, return blanks and
|                                                continue watching */
|
|     #pragma disable_handler
|     return (0);
| }
|
| /*****
| /*  FUNCTION NAME:  UNEXPECTED_HDLR          */
| /*
| /*  FUNCTION :      Handle unexpected exceptions that may occur */
| /*      during the invocation of this pgm.    */
| /*
| /*
| /*****
| void UNEXPECTED_HDLR (_INTRPT_Hndlr_Parms_T *errmsg)
| {
|     memcpy(error_detected_ptr,"*ERROR  ",10); /* An error occurred
|                                                on the watch exit program, return *ERROR
|                                                and End the watch session */
|
|     exit(EXIT_FAILURE);
| }

```

---

## Analyze and handle problems

Use this information to further analyze and handle problems, including a start problem analysis procedure that guides you through resolving the problem.

If you are experiencing problems with your system, you should gather more information about the problem to either solve it or report it. There are several options you can use to help you solve the problem, including:

- The Problem analysis procedures provide a list of yes or no questions that guide you down the path to pinpoint the problem. This is a good place to start when you are not sure what the problem is, or you are new to troubleshooting an iSeries server.
- The System Reference Code (SRC) list contains over 140 SRC groupings. It provides either a general idea of what the SRC means, or links to other sources of detailed information.
- A Main Storage Dump (MSD) is a process of collecting data from the system's main storage which can be helpful for the technical support personnel to help you analyze the problem further.
- Control language (CL) commands are the set of commands with which a user requests system functions.
- Problem-handling menus accommodate users of all skill levels in solving server problems. For example, the USERHELP menu provides basic problem-handling function where you can learn the simple task of using help. Alternatively, the NETWORK menu provides access to information that helps an operator handle problems throughout a network.
- Authorized Program Analysis Reports (APARs) are a request for a correction of a defect in a current release of an IBM-supplied program.

### Related concepts

"How your server manages problems" on page 2

Use this information to find out how your server manages problems.

## Problem analysis procedures

You can often solve problems that occur on your system with methodical analysis.

If you do need the help of a hardware service provider, you will need to have as much information to offer that person as possible to help them resolve the problem quickly and accurately.

### Things to keep in mind while troubleshooting problems

- Has there been an external power outage or momentary power loss?
- Has the hardware configuration changed?
- Has system software been added?
- Have any new programs or program changes been recently installed?

To make sure that your licensed programs and products have been correctly installed, use the Check Product Option (CHKPRDOPT) command.

- Have any system values changed?
- Has any system tuning been done?

After considering this information, you are ready to begin problem analysis. Go to Start problem analysis.

### Start problem analysis

Follow this procedure to narrow down a problem you are having on your server, and to gather the necessary information to report the problem to your next level of support.

1. Can you turn on your system?
  - **Yes:** Continue with the next step.
  - **No:** Go to “Recover from a system power problem” on page 13.
2. Does the Function/Data display on the system control display start with Function 11-3, or is the System Attention light on? Use the up and down arrow buttons to cycle through the functions to determine if an 11-3 exists. Press Enter to alternate between function and data.
  - **Yes:** Go to step 19 on page 11 to determine if an 11-3 exists.
  - **No:** Continue with the next step.
3. Is the system logically partitioned?
  - **Yes:** Continue with the next step.
  - **No:** Go to step 5.
4. Using system service tool (SST)/dedicated service tool (DST) from the primary partition console, select **Work with system partitions**, then select **Work with partition status**. Is there a partition with the state of Failed or Unit Attn?
  - **Yes:** Go to step 19 on page 11.
  - **No:** Continue with the next step.
5. Does the console show a Main Storage Dump Manager display?
  - **Yes:** Go to “Perform a main storage dump” on page 25.
  - **No:** Continue with the next step.
6. Does the display station that was in use when the problem occurred (or any display station) appear to be operational?

**Note:** The display station is operational if there is a signon display or a menu with a command line. If another display station is operational, use that display station to resolve the problem.

- **Yes:** Continue with the next step.
  - **No:** Choose from the following options:
    - If your console cannot vary on, go to “Recover when the console does not vary on” on page 17.
    - For all other workstations, go to “Recover from a workstation failure” on page 15.
7. Is a message related to this problem shown on the display station?
    - **Yes:** Continue with the next step.

- **No:** Go to step 12.
8. Is this a system operator message?
- Note:** It is a system operator message if the display indicates that the message is in the QSYSOPR message queue. Critical messages can be found in the QSYSMSG.
- **Yes:** Continue with the next step.
  - **No:** Go to step 10.
9. Is the system operator message highlighted, or does it have an asterisk (\*) by it?
- **Yes:** Go to step 18 on page 11.
  - **No:** Go to step 14.
10. Move the cursor to the message line and press F1 (for help), or use option 5 (Display details and reply). Does the Additional Message Information display appear?
- **Yes:** Continue with the next step.
  - **No:** Go to step 12.
11. Record the message information that is shown on the problem summary form. If possible, follow the recovery instructions on the Additional Message Information display. Did this solve the problem?
- **Yes: This ends the procedure.**
  - **No:** Continue with the next step.
12. Type `dspmsg qsysopr` on any command line and press Enter to display system operator messages. Did you find a message that is highlighted or has an asterisk (\*) by it?
- **Yes:** Go to step 18 on page 11.
  - **No:** Continue with the next step.
- Note:** Management Central's Message monitor can also inform you when a problem has developed.
13. Did you find a message at or near the time that the problem occurred?
- Use option 5 (Display details and reply) on the Work with Message display to determine the time that a message occurred.
- If the problem appears to affect only one display station, you might be able to use information from the JOB menu to diagnose and solve the problem. Type `G0 JOB` and press Enter on any command line to find this menu.
- **Yes:** Continue with the next step.
  - **No:** Go to step 16.
14. Perform the following steps:
- a. Use option 5 (Display details and reply) to display additional information about the message.
  - b. Record the message information that is shown on the problem summary form. If it indicates that you need to run problem analysis, go to step 18 on page 11.
  - c. If possible, follow any recovery instructions that are shown.
- Did this solve the problem?
- **Yes: This ends the procedure.**
  - **No:** Continue with the next step.
15. Were you instructed by the message information to look for additional messages in the system operator's message queue (QSYSOPR)?
- **Yes:** Press F12 (Cancel) to return to the list of messages and look for other related messages. Then, return to step 12.
  - **No:** Continue with the next step.
16. Do you know which input/output device is causing the problem?
- **No:** Continue with the next step.



- **Yes:** Perform the following steps:
    - a. Type ANZPRB on the command line and press Enter. See “Use the Analyze Problem (ANZPRB) command” on page 54 for additional information about analyzing a new problem.
    - b. Report the problem. See “Report problems detected by the system” on page 36 for information about using the problem log to report a problem electronically. **This ends the procedure.**
17. If you do not know which input/output device is causing the problem, describe the problems that you have observed by performing the following steps:
    - a. Type go userhelp on any command line and press Enter.
    - b. Select option 10 (Save information to help resolve a problem) on the Information and Problem Handling (USERHELP) menu. Type a brief description of the problem and press Enter on the Save Information to Help Resolve a Problem display. If you specify the default Y for the Enter notes about problem field and press Enter, the Select Text Type display appears that allows you to enter more text to describe your problem.
 

**Note:** To describe your problem in greater detail, see “Use the Analyze Problem (ANZPRB) command” on page 54. This command also might run a test to further isolate the problem.
    - c. Refer to “Report problems: Overview” on page 31 for more details.
  18. Perform the following steps:
    - a. Use option 5 (Display details and reply) to display additional information about the message.
    - b. Press F14, or use the Work with Problem (WRKPRB) command. See “Use the Work with Problems (WRKPRB) command” on page 58 for details.
    - c. If this does not solve the problem, see “Symptom and recovery actions” on page 12.
  19. Perform the following steps:
    - a. Make sure that you have collected all of the system reference codes.
    - b. Go to the System reference code list, find the system reference codes that you collected, and perform the actions indicated.

### Related concepts

“Gather information with the problem summary form” on page 31

The problem summary form is used to record information displayed on the system unit control panel.

### Related tasks

Scenario: Message monitor

“Collect system reference codes”

Record the system reference codes on the Problem summary form.

“System reference code list” on page 17

Use the tables below to locate the System Reference Code (SRC) that you have displayed. In the table, xxxx can be any number 0 through 9 or letter A through F.

### Related reference

“Create message queue QSYSMSG for severe messages” on page 48

You can create an optional message queue, QSYSMSG, to hold specific severe system messages.

## Collect system reference codes

Record the system reference codes on the Problem summary form.

If you have a Model 270 or 8xx:

1. Press the increment button until **05** appears on the Function/Data display and press Enter. Record the information that displays.
2. Press the increment button again until **11** appears on the Function/Data display and press Enter. Record the information that displays.
3. Press the increment button again, the number **12** displays. Press Enter, and record the 32-character code: 16 characters from line one, and 16 characters from line two, of the Function/Data display.

4. Press the increment button again, the number **13** displays on the first line of the Function/Data display. Press Enter, and record the 32-character code: 16 characters from line one, and 16 characters from line two, of the Function/Data display.
5. Press the increment button again until the number **20** displays on the first line of the Function/Data display. Press Enter, and record the 32-character code: 16 characters from line one, and 16 characters from line two, of the Function/Data display.

**Notes:**

1. For earlier models, if you have an expansion unit attached to your system, select **Function 05**, and record the system reference codes.
2. If **11-3** is shown in the Function/Data display on the control display, then the numbers that follow are the system reference codes.
3. If a number other than 11-3 is shown in the Function/Data display, the number might not indicate a problem with the system. These codes might indicate functions that you select from the control panel display.
4. If you have a display station with Type and Reference Code columns on it, record the data under the Type column as the first 4 characters of function 11 on the problem summary form. If an A, B, C, or D is displayed as the first digit in the Type column, use the data in the Reference Code column as the last four characters of function 11. Go to “Report problems: Overview” on page 31 for information about who to contact if you need more help.

**Related concepts**

“Gather information with the problem summary form” on page 31

The problem summary form is used to record information displayed on the system unit control panel.

**Related tasks**

“Start problem analysis” on page 9

Follow this procedure to narrow down a problem you are having on your server, and to gather the necessary information to report the problem to your next level of support.

**Symptom and recovery actions**



Use the problem-analysis symptom and recovery list to find the symptom you are experiencing and then perform the corresponding procedure.

1. Were you directed here from the problem-analysis procedure?
  - **Yes:** Continue with the next step.
  - **No:** Go to Start problem analysis.
2. Use the following table to find the symptom you are experiencing in the Symptom column, starting at the top of the list and moving down. Then, perform the procedure listed in the recovery procedure column.

*Table 1. Problem-analysis symptom and recovery list*

| Symptom   | Recovery procedure  |
|---|---|
| You cannot turn on the system   | See “Recover from a system power problem” on page 13.   |
| The system attention light is on, or a system reference code is displayed on the control panel. | See the “System reference code list” on page 17.  |
| The Operations Console Remote Control Panel feature is not working correctly.                   | See “Recover when the Operations Console remote control panel feature is not working correctly” on page 14. |
| A pushbutton or light on the control panel is not working correctly.                            | See “Recover when the control panel push buttons or lights are not working correctly” on page 14.           |
| You cannot perform an initial program load (IPL) or you suspect an operating system failure.    | See “Recover from IPL or system failures” on page 14.   |

Table 1. Problem-analysis symptom and recovery list (continued)

| Symptom   | Recovery procedure   |
|---|--|
| Your workstation or device (such as display or printer) is not working.   | See "Recover from a workstation failure" on page 15.   |
| You are having a problem with a tape or optical device.   | See "Recover from a tape or optical device problem" on page 16.  |
| You are having a problem with a disk or diskette unit.  | See "Recover from a disk or disk drive problem" on page 16.  |
| You cannot communicate with another device or computer.   | See "Recover from a communications problem" on page 16.  |
| Your system seems to be in a loop or hang condition.  | See "Recover from system hang or loop condition" on page 16.   |
| You are having an intermittent problem.   | See "Recover from an intermittent problem" on page 16.   |
| You are having data compression problems and receive this message: Message ID CPPEA02 along with system reference code (SRC) 6xxx 7051 - Compressed device and compression input/output adapter (IOA) are not compatible. | Go to "Recovering from SRC 6xxx 7051" in the Working with Disk Compression chapter in the Backup and Recovery guide<br><br>(about 570 pages). |
| You are having data compression problems and receive this message: Message ID CPPEA03 along with SRC 6xxx 7052 - Data compression warning.  | Go to "Recovering from SRC 6xxx 7052" in the Working with Disk Compression chapter in the Backup and Recovery guide<br><br>(about 570 pages). |
| The system has logical partitions and a state of Failed or Unit Attn is displayed on the Partition Status display of a secondary partition. There is a reference code.  | See the "System reference code list" on page 17.   |
| The system is logically partitioned and your partition seems to be in a loop or hang condition.   | See the "Recover from system hang or loop condition" on page 16.   |
| The system is logically partitioned and you cannot perform an initial program load (IPL), or you suspect an operating system failure.   | See the "Recover from IPL or system failures" on page 14.  |
| No symptom to match in the table.   | Go to the "Report problems: Overview" on page 31.  |

## Recover from a system power problem

Use this procedure to help resolve power problems.

Perform the following steps:

1. Make sure that the power that is supplied to the system is adequate. If your system units are protected by an Emergency Power Off (EPO) circuit, check that the EPO switch is not activated.
2. Verify that your system power cables are correctly connected to the electrical outlet. When power is available, the Function/Data display on the control panel is lit.
3. If you have an uninterruptible power supply, verify that the cables are correctly connected to the system, and that it is functioning.
4. Make sure all system units are powered on.
5. Is a system reference code displayed on the control panel?
  - **Yes:** Go to the "System reference code list" on page 17.
  - **No:** Contact your hardware service provider.

## Recover when the Operations Console remote control panel feature is not working correctly

Use this procedure to help resolve problems when the Operations Console remote control feature is not working correctly.

1. Are you able to change modes or select system functions using the Remote Control Panel feature?
  - **Yes:** Continue with the next step.
  - **No:** Make sure the Operations Console cable is attached correctly. Using the Operations Console display, disconnect and then reconnect the server connection. If the same failure occurs, contact your hardware service provider.
2. Are the Remote Control Panel functions (Function/Data, Mode and Power) correctly displayed?
  - **Yes:** Use the Remote Control Panel to start an IPL and continue with the next step.
  - **No:** Contact your hardware service provider.
3. Was the IPL successfully started?
  - **Yes:** Continue the IPL process.
  - **No:** Contact your hardware service provider.

## Recover when the control panel push buttons or lights are not working correctly

Use this procedure to help resolve a problem when the control panel push buttons or lights are not working correctly.

Try turning on the system again. If the control panel push buttons or lights still are not working correctly, contact your hardware service provider.

## Recover from IPL or system failures

Use this procedure to help recover from IPL or system failures.

If the system is logically partitioned, references to the system, console, displays, system commands, and system values are relative to the partition having a problem.

References to the control panel refer to the "Work with partition" status display functions if the problem is in a secondary partition, or the actual control panel if the problem is in the primary partition. If your system has logical partitions, see the Troubleshoot logical partitions topic.

Verify the following conditions:

- The device from which you performed the IPL is powered on.
- The tape and CD-ROM are loaded correctly.
- The sign-on user ID and password are correct.
- The system is set to the correct mode (Manual, Normal, Auto, or Secure).
- If this is a timed IPL, the system value for date/time and control panel mode is set correctly .
- If this is a remote IPL, the telephone, modem, control panel mode, and QRMTIPL value are set up correctly .

After you have checked for these conditions, perform the following steps:

1. Perform an IPL from the control panel or Operations Console Remote Control panel using the following steps:
  - a. Set the system to the **Manual** mode.
  - b. Choose from the following conditions:
    - If the system is turned on, select **Function 03** and press Enter to start an IPL.
    - If the system is turned off, ensure that the control panel is in either Normal or Manual mode and power on the system.

2. Sign on to the system when the Sign On display appears, and then continue with step 3. If you do not see the Sign On display, check to see if you have a new system reference code (SRC):
  - **Yes:** Go to the “System reference code list” on page 17.
  - **No:** Contact your next level of support. See the “Report problems: Overview” on page 31 for details.
3. On the IPL Options display, specify Yes for the following parameters:
  - Define or change the system at IPL
  - Clear output queues
  - Clear job queues
  - Clear incomplete job logs
4. Change the system value for QMCHPOOL to a smaller value.
5. Make sure the system value for QCTLSBSD has the correct spelling, or assign an alternative controlling subsystem.
6. Change the system value for QPWRDWNLMT to a larger value.
7. Continue the IPL process. If the same failure occurs, set the system to the Normal mode, and then contact your hardware service provider.

#### **Related concepts**

Troubleshoot logical partitions

### **Recover from a workstation failure**

Use this procedure to recover from a workstation failure.

1. Make sure all workstations and devices (such as displays or printers) are turned on.
2. If the Operations Console is being used as the console, ensure that the cable from the PC to the system is attached correctly. Make sure that the PC has been correctly configured.
3. Make sure that all workstation cables are attached correctly, and that all workstations are set to the correct address. For information about the workstation address, see the following information:
  - If you are using Operations Console, see “Determine the primary or alternative consoles” on page 62.
  - If you are using other workstations, see the Local Device Configuration book .
4. Ensure the following conditions exists:
  - Recently attached workstations have been correctly configured to the system.
  - Workstation addresses are unique (if applicable).
  - Workstations are terminated (if applicable).
5. Check all workstation printers for mechanical problems such as paper jams, ribbon failure, and so on.
6. Perform the following steps:
  - a. Vary off the failing workstation controller if any other workstation is operational, and then vary it on again. Follow these steps to vary on or off the workstation controller:
    - 1) Type WRKCFGSTS \*CTL on any command line. The Work with Configuration Status display appears.
    - 2) Specify 1 (Vary-on) or 2 (Vary-off) in the opt column next to your workstation controller, and press Enter.
  - b. End all active jobs before varying off the workstation controller using the Work with Active Jobs (WRKACTJOB) command.
7. Try the operation again. If you are still having the same problem, contact your hardware service provider.

## Recover from a tape or optical device problem

Use this procedure to help resolve tape or optical device problems.

Verify the following:

- All tapes or optical devices are powered on and in a Ready (enabled) condition.
- Cables between the system and the tape or optical device are correctly connected (if applicable).
- Tape density and tape bits per inch (BPI) match.
- Tape path is cleaned.
- CD-ROM disc is clean, the format is supported, and the disc is loaded correctly with the label side showing.

Do all the tapes or CD-ROM device fail to read or write?

- **Yes:** Contact your hardware service provider.
- **No:** Replace the tape or CD and try the operation again. If the same failure occurs, contact your hardware service provider.

## Recover from a disk or disk drive problem

Use this procedure to help resolve disk or disk drive problems.

1. Make sure that all disk and diskette units are powered on and enabled. Some disk units might have enable switches.
2. Make sure cables are correctly connected between the system and disk or diskette unit (if applicable).
3. Do all diskettes fail to read or write?
  - **Yes:** Contact your hardware service provider.
  - **No:** Replace the diskette and try the operation again. If the same failure occurs, contact your hardware service provider.

## Recover from a communications problem

Use this procedure to help resolve problems with communications.

1. Make sure that all communications equipment, such as modems or transceiver are powered on.
2. Make sure all communications cables are correctly connected.
3. Make sure the remote system is ready to receive communications.
4. Verify the network equipment (or provider) is functional. This includes telephone service (for example, verify the status of communications lines).
5. Verify that the configuration is correctly specified for the failing communications or LAN facility.
6. If you still have the same problem, contact your hardware service provider.

## Recover from system hang or loop condition

Use this procedure to help resolve system hang or loop conditions.

1. See the information in "Perform a main storage dump" on page 25 to gather data on the current state of the system during the loop or hang condition. This information is critical for problem solving. Valuable diagnostic information will be lost if you do not collect the storage dump information before you try to perform an IPL.
2. Contact your hardware service provider after performing the main storage dump.

## Recover from an intermittent problem

Use this procedure to help resolve intermittent problems.

1. Enter the Analyze Problem (ANZPRB) command on any command line. The Select Type of System display appears.
2. Select option 1 (This server or attached device). The Analyze problem display appears.
3. Select option 3 (Hardware problem). The Problem Frequency display appears.

4. Select option 1 (Yes) to get an intermittent checklist and follow the instructions.
5. If you still have the same problem, contact your hardware service provider.

## Recover when the console does not vary on

Use this procedure to help resolve console vary-on problems.

If the system is logically partitioned, references to the system, console, displays, system commands, and system values are relative to the partition having a problem. References to the control panel refer to the "Work with partition" status display functions if the problem is in a secondary partition, or the actual control panel if the problem is in the primary partition.

1. Locate the workstation that is used as the primary console. See "Determine the primary or alternative consoles" on page 62.
2. Make sure the workstation cables are attached correctly and set to the correct address.
3. Can you sign on to an alternative console?
  - **Yes:** Continue with the next step.
  - **No:** Go to step 5.
4. If you can sign on to an alternative console, perform the following steps:
  - a. Make sure the primary console controller (for example, CTL01) and device description (for example, DSP01) have been created or restored. To check the device description, use the command `WRKCFGSTS *CTL`.
  - b. If descriptions exist, check the system operator message to determine why the primary console failed.
  - c. Take corrective actions indicated in the message.
  - d. If you still cannot solve the problem, set the system to the Normal mode and call your software service representative.
5. If you cannot sign on to an alternative console, perform the following steps:
  - a. Set the system to the **Manual** mode, select **function 3**, and press Enter to start an IPL. You will see the IPL Option display.
  - b. Were you able to get to the IPL Option display?
    - **No:** Contact your hardware service provider.
    - **Yes:** On the IPL Options display, specify **Y** (Yes) in the Define or change system at IPL field, **N** (No) in the Set major system option field and press Enter. The Configuration Commands menu appears.
  - c. Select **option 2** (Controller description commands) to see the controller description for the console. Verify that the controller (for example, CTL01) was created correctly. If the name has been changed, see Find the primary console when the system is operational in this topic.
  - d. Select **option 3** (Device description commands) to see the device description for the console. Verify that the device (for example, DSP01) was created correctly. If the name has been changed, see Find the primary console when the system is operational in this topic.

## System reference code list

Use the tables below to locate the System Reference Code (SRC) that you have displayed. In the table, xxxx can be any number 0 through 9 or letter A through F.

The SRCs are grouped in ranges, although the recovery for each range might not apply to every SRC within the range. If you cannot find your SRC range in this table, call your next level of support.

The codes in this list are organized by their first character, with numbers coming before letters. To navigate this listing, click or go to the number or letter below that matches the first character of your SRC. Then, select your SRC from the list provided.

For each SRC range, there will be a brief description of what the SRC range indicates, and what you should do. If the recommendation does not solve the problem, or if there is no recommended way to solve the problem, contact your hardware service provider.

**0**

These SRCs start with 0.

| SRC                    | What it means, and what you should do   |
|------------------------|---|
| 0000 xxxx              | Check for a specific 0000 SRC below. If you do not see your SRC below, a control panel failure may have been detected.  |
| 0000 AABB<br>0000 AACC | You attempted a timed, remote, or automatic Initial Program Load (IPL) with the system in the Secure or Manual mode.<br><br>Perform the following steps:<br>Set the system to the Normal or Auto mode and perform an IPL again. |
| 0000 AADD              | You attempted a manual IPL with the system in the Secure or Auto mode.<br><br>Set the system to the Normal or Auto mode and perform an IPL again.   |

**1**

These SRCs start with 1.

| SRC                    | What it means   |
|------------------------|---|
| 1xxx xxxx              | Check for a specific 1xxx SRC below. If you do not see your SRC below, a System Power Control Network (SPCN) failure may have been detected.  |
| 1xxx D101<br>1xxx D102 | Either a battery power unit x failed, or a battery power unit x test failed.<br><br>Replace the battery power unit. See “Replace the battery power unit on Models 5xx and expansion units FC 507x and FC 508x” on page 63. If the battery still does not work after the replacement, call your hardware service provider. |

**2**

These SRCs start with 2.

| SRC       | What it means  |
|-----------|--|
| 2105 xxxx | It may indicate a disk unit failure.   |
| 2107 xxxx | It may indicate a disk unit failure.   |
| 2629 xxxx | It may indicate a Storage IOA failure.   |
| 2644 3136 | It may indicate a software installation error. See Common SRCs for software installation for more information. |
| 2718 xxxx | It may indicate a Storage IOA failure.   |
| 2724 xxxx | It may indicate an I/O adapter Licensed Internal Code, or incompatible hardware failure.                       |
| 2726 xxxx | It may indicate a Storage IOA failure.   |
| 2728 xxxx | It may indicate a Storage IOA failure.   |



| <b>SRC</b> | <b>What it means</b>   |
|------------|--|
| 2729 xxxx  | It may indicate a Storage IOA failure.   |
| 2740 xxxx  | It may indicate a Storage IOA failure.   |
| 2741 xxxx  | It may indicate a Storage IOA failure.   |
| 2742 xxxx  | It may indicate an I/O adapter hardware failure.   |
| 2743 xxxx  | It may indicate an I/O adapter hardware failure.   |
| 2744 xxxx  | It may indicate an I/O adapter Licensed Internal Code, or incompatible hardware failure.   |
| 2745 xxxx  | It may indicate an I/O adapter hardware failure.   |
| 2746 xxx   | It may indicate a Twinaxial - Workstation Adapter error.   |
| 2748 xxxx  | It may indicate a system bus failure.  |
| 2749 xxxx  | It may indicate an I/O processor configuration error.  |
| 2750 xxxx  | It may indicate an I/O adapter hardware failure.   |
| 2751 xxxx  | It may indicate an I/O adapter hardware failure.   |
| 2757 xxxx  | It may indicate a system bus failure.  |
| 2760 xxxx  | It may indicate an I/O adapter hardware failure.   |
| 2761 xxxx  | It may indicate an I/O adapter hardware error.   |
| 2763 xxxx  | It may indicate a system bus failure.  |
| 2765 xxxx  | It may indicate an I/O processor failure.  |
| 2766 xxxx  | It may indicate an I/O processor configuration error   |
| 2767 xxxx  | It may indicate an I/O processor error.  |
| 2768 xxxx  | It may indicate an I/O processor error.  |
| 2771 xxxx  | It may indicate an incompatible hardware detected, I/O adapter Licensed Internal Code failed, or one half of I/O adapter failed. |
| 2772 xxxx  | It may indicate an incompatible hardware error, or I/O adapter Licensed Internal Code failure.                                   |
| 2778 xxxx  | It may indicate a system bus failure.  |
| 2780 xxxx  | It may indicate a system bus failure.  |
| 2782 xxxx  | It may indicate a system bus failure.  |
| 2787 xxxx  | It may indicate an I/O processor configuration error.  |
| 2793 xxxx  | It may indicate an I/O adapter hardware error.   |
| 2805 xxxx  | It may indicate an I/O adapter hardware error.   |
| 2809 xxxx  | It may indicate a Storage IOA failure.   |
| 2810 xxxx  | It may indicate a Storage IOA failure.   |
| 281x xxxx  | It may indicate an I/O adapter hardware error.   |
| 2824 xxxx  | It may indicate a Storage IOA failure.   |
| 282C xxxx  | It may indicate a Storage IOA failure.   |
| 2838 xxxx  | It may indicate an I/O adapter Licensed Internal Code failure.   |
| 283C xxxx  | It may indicate a device backplane problem.  |
| 283D xxxx  | It may indicate a device backplane problem.  |
| 283F xxxx  | It may indicate a device backplane problem.  |
| 2842 xxxx  | It may indicate an I/O processor error.  |
| 2843 xxxx  | It may indicate an I/O processor error.  |

| <b>SRC</b> | <b>What it means</b>   |
|------------|--|
| 2844 xxxx  | It may indicate an I/O processor error.  |
| 2849 xxxx  | It may indicate an I/O adapter Licensed Internal Code failure, or incompatible hardware error. |
| 284B xxxx  | It may indicate an I/O processor error.  |
| 284C xxxx  | It may indicate an I/O processor error.  |
| 284D xxxx  | It may indicate an I/O processor error.  |
| 284E xxxx  | It may indicate an I/O processor error.  |
| 286C xxxx  | It may indicate an I/O processor error.  |
| 286D xxxx  | It may indicate an I/O processor error.  |
| 286E xxxx  | It may indicate an I/O processor error.  |
| 286F xxxx  | It may indicate an I/O processor error.  |
| 287F xxxx  | It may indicate an I/O adapter hardware error detected.  |
| 28B9 xxxx  | It may indicate an device backplane problem.   |
| 28BC xxxx  | It may indicate an device backplane problem.   |
| 28CB xxxx  | It may indicate an device backplane problem.   |
| 28CC xxxx  | It may indicate an device backplane problem.   |
| 28CD xxxx  | It may indicate an device backplane problem.   |

### 3

These SRCs start with 3.

| <b>SRC</b> | <b>What it means</b>                    |
|------------|---|
| 3490 xxxx  | It may indicate a tape unit problem.    |
| 3494 xxxx  | It may indicate a tape library problem. |
| 3570 xxxx  | It may indicate a tape unit problem.    |
| 358x xxxx  | It may indicate a tape unit problem.    |
| 3590 xxxx  | It may indicate a tape unit problem.    |

### 4

These SRCs start with 4.

| <b>SRC</b> | <b>What it means</b>                 |
|------------|--------------------------------------|
| 432x xxxx  | It may indicate a disk unit failure. |

### 5

These SRCs start with 5.

| <b>SRC</b> | <b>What it means</b>                           |
|------------|--|
| 5306 xxxx  | It may indicate a device backplane problem.    |
| 5700 xxxx  | It may indicate an I/O adapter hardware error. |
| 5701 xxxx  | It may indicate an I/O adapter hardware error. |

| SRC       | What it means   |
|-----------|---|
| 5702 xxxx | It may indicate a problem with an I/O processor.      |
| 5703 xxxx | It may indicate a system bus failure.                 |
| 5704 xxxx | It may indicate an I/O processor configuration error. |

## 6

These SRCs start with 6.

| SRC       | What it means   |
|-----------|---|
| 6149 xxxx | It may indicate an I/O adapter Licensed Internal Code failure.                      |
| 63xx xxxx | A tape unit failed. See "Recover from a tape or optical device problem" on page 16. |
| 6532 xxxx | It may indicate a Storage IOA failure.  |
| 6533 xxxx | It may indicate a Storage IOA failure.  |
| 6534 xxxx | It may indicate a Storage IOA failure.  |
| 660x xxxx | It may indicate a disk unit failure.  |
| 671x xxxx | It may indicate a disk unit failure.  |
| 671A xxxx | It may indicate a Storage IOA failure.  |
| 673x xxxx | It may indicate a disk unit failure.  |
| 6A59 xxxx | It may indicate a workstation adapter console failure.                              |

## 7

These SRCs start with 7.

| SRC       | What it means                             |
|-----------|---|
| 7207 xxxx | It may indicate a tape unit error.        |
| 7208 xxxx | It may indicate a 8mm tape drive failure. |

## 9

These SRCs start with 9.

| SRC       | What it means   |
|-----------|---|
| 93xx xxxx | A disk or diskette unit failed. See "Recover from a disk or disk drive problem" on page 16. |
| 8427 xxxx | It may indicate a tape library failure.   |

## A

These SRCs start with A.

| SRC       | What it means  |
|-----------|--|
| A1xx xxxx | Check for a specific A1xx SRC below. If you do not see your SRC below, it can indicate an IPL load device failure. See "Recover from IPL or system failures" on page 14. |
| A12x 19xx | It may indicate a software installation error. See Common SRCs for software installation for more information.   |

| SRC       | What it means   |
|-----------|---|
| A1xx 19xx | It may indicate a software installation error. See Common SRCs for software installation for more information.  |
| A6xx xxxx | Check for a specific A6xx SRC below. If you do not see your SRC below, it can mean a Licensed Internal Code error was detected. See Common SRCs for software installation for more information.   |
| A6xx 0277 | <p>A compression disk unit cannot complete an operation.</p> <ol style="list-style-type: none"> <li>Do <b>not</b> turn off the system when performing this procedure.</li> <li>Look at the 4 characters that are to the left of the Data display of function 17-3. These 4 characters indicate the type of problem that exists and the recovery action to perform.</li> <li>Are these character 8402 or 2002? <ul style="list-style-type: none"> <li><b>No:</b> Continue with step 4.</li> <li><b>Yes:</b> The compression disk unit is temporarily full of data. The command to the compression disk is being held. When the subsystem controller has created sufficient space on the compression disk unit to contain the data, the command that is being held is released and the system resumes normal processing. If the system does not resume normal processing within 20 minutes, contact your hardware service provider.</li> </ul> </li> <li>If these characters are 8400 or 2000, the compression disk unit is full of data. The command to the compression disk is being held. Go to Disk unit full considerations in Backup and Recovery <div style="text-align: center;">  <p>book.</p> </div> </li> </ol> |
| A600 11xx | It may indicate a software installation error. See Common SRCs for software installation for more information.  |
| A6xx 500x | It may indicate a workstation controller failure. See “Recover from a workstation failure” on page 15.  |
| A600 50xx | It may indicate an Operations Console error. See Troubleshoot system reference code (SRC) data for Operations Console.  |
| A9xx xxxx | Check for a specific A9xx SRC below. If you do not see your SRC below, it may indicate an application error.  |
| A900 xxxx | It may indicate an Operations Console error. See Troubleshoot system reference code (SRC) data for Operations Console.  |
| A900 2000 | <p>If the IPL completed normally, does the console have a sign-on screen?</p> <p><b>Note:</b> If the console did not vary on, see “Recover when the console does not vary on” on page 17.</p> <ol style="list-style-type: none"> <li>If the system completed the IPL, check the QSYSARB job log for a message, and follow the corrective actions indicated. To view the QSYSARB job log: <ol style="list-style-type: none"> <li>Use the Work with Active Jobs (WRKACTJOB) command, then type 5 (Work with) next to the QSYSARB job.</li> <li>Select Option 10 (Display jobs) to view the job log. You need *QSECOFR user class, or *ALLOBJ and *JOBCTL special authority to view the job log.</li> </ol> </li> <li>If the problem persists, contact your hardware service provider.</li> </ol>  |

## B

These SRCs start with B.

| SRC              | What it means   |
|------------------|---|
| B0xx xxxx        | Check for a specific B0xx SRC below. If you do not see your SRC below, it can mean a communications Licensed Internal Code failure was detected. <ol style="list-style-type: none"> <li>1. Make sure the latest fix package is installed.</li> <li>2. If this does not solve the problem, call your software service representative.</li> </ol> |
| B003 xxxx        | It may indicate an asynchronous Communications failure.   |
| B006 xxxx        | It may indicate a common Licensed Internal Code failure.  |
| B070 xxxx        | It may indicate a no response, time-out temporary error.  |
| <b>B1xx xxxx</b> | Check for a specific B1xx SRC below. If you do not see your SRC below, it can mean an IPL load device failure. See "Recover from IPL or system failures" on page 14.  |
| B101 4500        | It may indicate an error with the Integrated xSeries® Server for iSeries. See Common SRCs for software installation for more information.   |
| B1xx 45xx        | It may indicate a software installation error. See Common SRCs for software installation for more information.  |
| B2xx xxxx        | It may indicate a Logical partition error. See Logical partition SRC finder for more information.   |
| B350 420A        | It may indicate a software installation error. See Common SRCs for software installation for more information.  |
| B427 xxxx        | It may indicate a system processor failure.   |
| B428 xxxx        | It may indicate a system processor failure.   |
| B437 xxxx        | It may indicate a system processor failure.   |
| B448 xxxx        | It may indicate a system processor failure.   |
| B467 xxxx        | It may indicate a system processor failure.   |
| B4FF xxxx        | It may indicate a system processor failure.   |
| <b>B6xx xxxx</b> | Check for a specific B6xx SRC below. If you do not see your SRC below, it can mean a Licensed Internal Code error was detected.   |
| B600 500x        | It may indicate an Operations Console error. See Troubleshoot system reference code (SRC) data for Operations Console.  |
| B600 53xx        | It may indicate a Logical partition error. See Logical partition SRC finder for more information.   |
| B608 1105        | It may indicate a software installation error. See Common SRCs for software installation for more information.  |
| <b>B9xx xxxx</b> | Check for a specific B9xx SRC below. If you do not see your SRC below, it can mean an i5/OS IPL failure. See "Recover from IPL or system failures" on page 14.  |
| B900 3121        | It may indicate a software installation error. See Common SRCs for software installation for more information.  |

## C

These SRCs start with C.

| SRC       | What it means  |
|-----------|--|
| C1xx xxxx | These SRCs show the Status of an IPL. See the IPL SRC finder for details, then perform "Recover from IPL or system failures" on page 14. |
| C2xx xxxx | These SRCs show the Status of an IPL. See the IPL SRC finder for details, then perform "Recover from IPL or system failures" on page 14. |

| SRC       | What it means  |
|-----------|--|
| C3xx xxxx | These SRCs show the Status of an IPL. See the IPL SRC finder for details, then perform "Recover from IPL or system failures" on page 14. |
| C5xx xxxx | These SRCs show the Status of an IPL. See the IPL SRC finder for details, then perform "Recover from IPL or system failures" on page 14. |
| C6xx xxxx | These SRCs show the Status of an IPL. See the IPL SRC finder for details, then perform "Recover from IPL or system failures" on page 14. |
| C9xx xxxx | These SRCs show the Status of an IPL. See the IPL SRC finder for details, then perform "Recover from IPL or system failures" on page 14. |
| CAxx xxxx | These SRCs show the Status of an IPL. See the IPL SRC finder for details, then perform "Recover from IPL or system failures" on page 14. |

## D

These SRCs start with D.

| SRC       | What it means   |
|-----------|---|
| D1xx xxxx | <p>Check for a specific D1xx SRC below. If you do not see your SRC below, then the SRC is reporting IPL status. This is a normal indication while the system main storage is being saved to disk. See the IPL SRC finder for details.</p> <p>If the system is still not running correctly after 30 minutes, contact your hardware service provider.</p>                                     |
| D1xx 3xxx | <p>Service Processor Main Storage Dump status reference code. This is a normal reference code showing the status of the system when performing a main storage dump.</p> <p>You may suspect that the system is not operating correctly when the rightmost characters do not change for 2 minutes.</p> <p><b>Note:</b> It takes approximately 1 minute to dump each 20MB of main storage.</p> |
| D100 80xx | Operations Console error. See Troubleshoot system reference code (SRC) data for Operations Console.   |
| D2xx xxxx | These SRCs show the Status of an IPL. This is a normal indication while the panel functions and system code are powering down the system. See the IPL SRC finder for details, then perform "Recover from IPL or system failures" on page 14.  |
| D6xx xxxx | <p>These SRCs show the Status of an IPL. This is a normal indication while the system is being powered down. See the IPL SRC finder for details.</p> <p>If the system does not start normally after 30 minutes, call your software service representative. When xxxx is changing, the system is doing a main storage dump.</p>  |
| D9xx xxxx | These SRCs show the Status of an IPL. See the IPL SRC finder for details, then perform "Recover from IPL or system failures" on page 14.  |
| DAxx xxxx | These SRCs show the Status of an IPL. See the IPL SRC finder for details, then perform "Recover from IPL or system failures" on page 14.  |

## E

These SRCs start with E.

| SRC       | What it means                            |
|-----------|--|
| E600 xxxx | It may indicate a control panel failure. |

## F

These SRCs start with F.

| SRC       | What it means                            |
|-----------|--|
| F000 xxxx | It may indicate a control panel failure. |

#### Related concepts

“System reference codes” on page 2

A system reference code (SRC) is a set of eight characters that identifies the name of the system component that detects the error codes and the reference code that describes the condition.

#### Related tasks

“Start problem analysis” on page 9

Follow this procedure to narrow down a problem you are having on your server, and to gather the necessary information to report the problem to your next level of support.

## Perform a main storage dump

If the system is logically partitioned, references to the system, console, displays, system commands, and system values are relative to the partition having a problem.

A main storage dump (MSD) is a process of collecting data from the system’s main storage. It can be done in the following ways:

- **Automatically.** By the service processor as the result of a system failure.
- **Manually.** By performing a function 22 on the control panel when the system waits, loops, or appears to have an operating system failure. You can perform this task by selecting **option 22** from the Work with partition status display.

Choose the task to perform:

- Perform an automatic main storage dump
- Perform a manual main storage dump
- Perform a manual main storage dump on a logical partition
- Copy a current main storage dump
- Report a main storage dump
- Delete a main storage dump

### Perform an automatic main storage dump

After a failure that causes the system to perform an MSD, the Main Storage Dump Occurred display appears.

When that occurs, go to “Copy a current main storage dump” on page 26.

### Perform a manual main storage dump

Use this procedure on the primary partition or on a system without logical partitions.

To place the data from the system’s main storage to the load-source disk, perform the following procedure:

1. If your system has logical partitions, try to power them off.
2. Verify that there are no interactive jobs running.
  - a. Select **Manual** mode.
  - b. Use the Increment/Decrement buttons to display **function 22** (main storage dump).
  - c. Press Enter on the control panel.
3. Is 0000 0000 displayed on the control panel for more than 30 seconds?

- **Yes:** The multiple function input/output processor (IOP) or service processor is not responding to a request from the control panel. Go to the “Report problems: Overview” on page 31. **This ends the procedure.**
  - **No:** An attention SRC, A1xx 3022, is displayed, which indicates that function 22 has been selected.
4. Reselect **function 22**, press Enter on the control panel, and wait for the dump to complete. When the dump is complete, the Main Storage Dump Occurred display is shown. The appearance of an A1D0 300x or A6Dx 3000 SRC on the Main Storage Dump Occurred display indicates a successful manual MSD.
  5. Go to the “Report a main storage dump” on page 27. **This ends the procedure.**

## Perform a manual main storage dump on a logical partition

Use this procedure on a logical partition.

- | **Attention:** You should only perform a secondary partition main storage dump (MSD) if under the  
| direction of software support.

To place the data from the system’s main storage to the load-source disk, perform the following procedure:

1. On the logical partition or on the primary partition, start Dedicated Service Tools (DST).
2. Select option 11 (Work with system partitions).
3. Select option 2 (Work with partition status).
4. Select the logical partition on which you want to perform the MSD. Initiating a MSD against the primary partition is equivalent to initiating a MSD from the control panel.
5. Is the partition in Manual mode?
  - **Yes:** Continue to the next step.
  - **No:** Select option 10 (Mode manual).
6. Select option 22 (Force Main Storage Dump).
7. Select option 10 to confirm. Wait for the dump to complete. When the dump is complete, the Main Storage Dump Occurred display is shown on the selected logical partition.
8. The appearance of an A1D0 300x or A6Dx 3000 SRC on the Main Storage Dump Occurred display indicates a successful manual MSD.
9. Go to “Report a main storage dump” on page 27.

## Copy a current main storage dump

This procedure copies a main storage dump (MSD) to a predefined storage area on the system.

To prevent an MSD from being overwritten when another dump occurs, complete the following steps:

1. From the Main Storage Dump Occurred display, press Enter. The Main Storage Dump Manager appears.
2. Select option 1 (Work with current main storage dump). The Work with Current Main Storage Dump display appears.
3. Select option 1 (Display/Print). The Display Main Storage Dump display appears.
4. Select option 1 (MSD summary). The Main Storage Dump Summary display appears. This display shows the system reference code, date, and time of the MSD, and Licensed Internal Code level.
5. Record the summary information and report it to your service provider.
6. Press F12 (Cancel) twice to return to the Main Storage Dump Manager display.
7. Select option 3 (Copy to ASP). The Copy Main Storage Dump to ASP display appears.
8. Type a dump description, then press Enter to start copying the dump. After the dump is copied, a message will be displayed indicating whether the MSD copy completed.
9. Did a message indicate Copy completed normally?



- **Yes: This ends the procedure.**
  - **No:** Continue with the next step
10. Has your service provider requested a tape copy of the MSD?
    - **Yes:** Continue to the next step.
    - **No:** Work with your service provider on the problem.
  11. To copy MSD to a tape device, follow these steps:
    - a. Select option 2 (Copy to media). The Copy Main Storage Dump to Media display appears.
    - b. Load the media and follow the instruction on the display.
    - c. When the copy procedure is successfully completed, process the tape according to your service provider's instruction. If you encounter a problem with the copy procedure, contact your service provider. **This ends the procedure.**

### Report a main storage dump

If your system has the Main Storage Dump auto copy enabled, your system may have automatically copied the current MSD to the ASP using dump description Auto Copy, and then re-IPLed the system.

1. On any command line, enter STRSST.
2. Select option 1 (Start a service tool). The Start a Service Tool display appears.
3. Select option 6 (Main storage dump manager). The Main Storage Dump Manager display appears.
4. Select option 2 (Work with copies of main storage dumps). The Work with Copies of Main Storage Dumps display appears.
5. Find the dump with the description of Auto Copy and select option 5 (Display/Print). The Display Main Storage Dump display appears.
6. Select option 1 (MSD Summary). The Main Storage Dump Summary display appears. This display shows the system reference code, date, and time of the MSD, and Licensed Internal Code level. Report the summary information to your service provider.
7. Press F3 (Exit) to return to the Work with Copies of Main Storage Dumps Display.
8. If the dump has a description of Auto Copy, rename it so that another auto copy and re-IPL can occur if necessary.
  - a. Select option 7 (Rename). The Rename Main Storage Dump display appears.
  - b. Type a new dump description, and press Enter.
9. Has your service provider requested a tape copy of the MSD?
  - **Yes:** Continue to the next step.
  - **No:** Work with your service provider on the problem.
10. To copy an MSD to a tape device, perform the following steps:
  - a. Select option 8 (Copy to media). The Copy Main Storage Dump to Media display appears.
  - b. Load the media and follow the instructions on the display.
  - c. When the copy procedure is successfully completed, process the tape according to your service provider's instruction. If you encounter a problem with the copy procedure, contact your service provider.
11. Continue with "Delete a main storage dump."

### Delete a main storage dump

This procedure is used when dump copies are no longer needed by your service provider.

1. On any command line, enter STRSST.
2. Select option 1 (Start a service tool). The Start Service Tool display appears.
3. Select option 6 (Main storage dump manager). The Main Storage Dump Manager display appears.
4. Select option 2 (Work with copies of main storage dumps). The Work with Copies of Main Storage Dumps display appears where you can see the list of dump copies.

5. If you want to delete any dump copies, type 4 next to the dump copies, and press Enter twice.
6. To exit SST, press F3 (Exit) three times, and then press Enter.

## CL commands

You can use problem analysis control language (CL) commands to help you manage problems you are experiencing with your system.

Refer to the following information for details:

- The Use the Analyze Problem (ANZPRB) command shows you how to start problem analysis for user-detected problems.
- The Use the Verify Communications (VFYCMN) command shows you how to verify either remote or local communications equipment.
- The Use the Verify Tape (VFYTAP) command shows you how to use the Verify Tape command.
- The Use the Work with Alerts (WRKALR) command shows you how to use the Work with Alerts command to remotely analyze system-detected problems.
- The Use the Work with Problems (WRKPRB) command shows how you can gather more information about a problem to either solve it or to report it without the help of a hardware service provider.

Continue with the Problem-handling menus topic.

### Related concepts

“Use the Verify Tape (VFYTAP) command” on page 57

Use the Verify Tape (VFYTAP) command to start procedures that verify whether the specified tape unit is operating.

“Problem-handling menus”

Use the problem-handling menus to help analyze problems.

### Related tasks

“Use the Analyze Problem (ANZPRB) command” on page 54

Use the Analyze Problem (ANZPRB) command to start problem analysis for user-detected problems.

“Use the Verify Communications (VFYCMN) command” on page 56

The Verify Communications (VFYCMN) command allows you to verify either remote or local communications equipment.

“Use the Work with Alerts (WRKALR) command” on page 57

Use the Work with Alerts (WRKALR) command to remotely analyze system-detected problems that cause the service requester to create and send them to the service provider.

“Use the Work with Problems (WRKPRB) command” on page 58

With problem analysis, you can gather more information about a problem to either solve it or to report it without the help of a hardware service provider.

## Problem-handling menus

Use the problem-handling menus to help analyze problems.

Your server problems can originate from the following areas:

- Job or programming
- System performance
- Equipment
- Communications

If you are experiencing problems with your system, use the following problem-handling menus to help analyze problems. The order of the menus listed is from basic skill level to advanced skill level.

- Solving user problems using the GO USERHELP menu. This menu is for the novice who wants to learn about using help and who needs help in analyzing problems.
- Solving problems using the GO PROBLEM menu. This is the main menu for working with problems.
- Solving system problems using the GO PROBLEM2 menu. This menu allows you to work with programming problems and system performance.
- Solving system problems using the GO TECHHELP menu. Use this menu if you encounter problems related to system operation.
- Solving network problems using the GO NETWORK menu. This menu allows you to manage and use network communications.
- Solving network problems using the GO NETPRB menu. This menu allows you to handle problems that relate to communications.

Continue with the Use Authorized Program Analysis Reports (APARs) topic.

#### **Related concepts**

“CL commands” on page 28

You can use problem analysis control language (CL) commands to help you manage problems you are experiencing with your system.

“Use authorized program analysis reports”

An authorized program analysis report (APAR) is an IBM-supplied program that allows you to create a diskette file or a tape file that contains information from your system to help software service representatives to correct programming problems.

#### **Related tasks**

“Use the GO USERHELP menu” on page 61

This menu is for the novice who wants to learn about using help and who needs help in analyzing problems.

“Use the GO PROBLEM menu” on page 60

The problem-handling (PROBLEM) menu is the main menu for working with problems.

“Use the GO PROBLEM2 menu” on page 60

The second problem-handling (PROBLEM2) menu is an extension of the PROBLEM menu.

“Use the GO TECHHELP menu” on page 60

If you encounter problems that are related to system operation, start with the Technical Support Tasks (TECHHELP) menu.

“Use the GO NETWORK menu” on page 59

From the network management (NETWORK) menu, you can manage and use network communications.

“Use the GO NETPRB menu” on page 59

From the network problem-handling (NETPRB) menu, you can handle problems that relate to communications.

## **Use authorized program analysis reports**

An authorized program analysis report (APAR) is an IBM-supplied program that allows you to create a diskette file or a tape file that contains information from your system to help software service representatives to correct programming problems.

This topic also includes details on using the APAR command.

The APAR procedure creates one or more diskette files or tape files that contain information about the following areas:

- Control storage dump area. This area is control-block storage that is used by the Licensed Internal Code.
- Input/output controller storage dump area.

- The system work area (if you are not running the APAR procedure during IPL after a system dump), including the following information:
  - The system configuration
  - The disk Volume Table of Contents (VTOC)
  - The #SYSWORK index
  - The trace work area
  - The security work area
  - The program temporary fix (PTF) work area
  - The diskette VTOC
  - The volume label
  - The IPL bootstrap
- PTF logs for the IBM licensed program library and system library.
- The system service log.
- The disk trace files. If you do not run the APAR procedure during startup, and you do not copy a task dump, then the system displays a trace file prompt and you can select up to 16 trace files to copy.
- Microcode tables
- Task dump file (optional)
- The history file
- The spooled file (optional)
- The job queue (optional)
- The message file (optional)
- The product-level data file

The APAR procedure can copy a specified load member to a file named APARLOAD, a specified source member to a file named APARSRCE, or a specified procedure member to a file named APARPROC which can be saved to diskette or tape. When the APAR procedure begins running, you can select the spooled file, job queue, message file, and user file index that the system will copy. Most of the data areas that are copied can be displayed using the DUMP procedure.

## Use APARs to collect diagnostic information

Run the authorized program analysis report (APAR) procedure during an IPL after you have performed a system dump. The procedure requires an attended IPL.

To perform the APAR procedure, enter the following command:

```
APAR valid,[object],[source],[proc],[dumpfile],[S1],[AUTO/NOAUTO],[I1/TC/T1/T2]
```

### Related concepts

“Problem-handling menus” on page 28

Use the problem-handling menus to help analyze problems.

“Use authorized program analysis reports” on page 29

An authorized program analysis report (APAR) is an IBM-supplied program that allows you to create a diskette file or a tape file that contains information from your system to help software service representatives to correct programming problems.

### Related reference

“Details: Authorized program analysis reports” on page 61

You can use these parameters for the APAR command.

Save APAR Data (SAVADATA)

Restore APAR Data (RSTAPARDTA)

---

## Report problems: Overview

Use this information to learn what information you should gather about your problem, how to report and track problems, and how to send a service request.

For problems with software or Licensed Internal Code, you should notify the IBM service system of the failure and related symptoms. The problems that are detected by the server can be reported either manually or automatically.

If a problem is new, a Problem Management Record (PMR) is created by the IBM service system. The PMR number is returned to your server. If your contract with IBM allows voice support (telephone), an IBM service center personnel will contact you if requested, and work with you to resolve the problem. If you do not have voice support, you can view the service center's response by using the Query Problem Status (QRYPRBSTS) command.

When you report problems to your hardware service provider, you should provide as much information as you can about the problem so that they can resolve the problem quickly and efficiently.

### Related concepts

"How your server manages problems" on page 2

Use this information to find out how your server manages problems.

"Query problem status" on page 37

To find the latest status of a reported problem.

## Gather information with the problem summary form

The problem summary form is used to record information displayed on the system unit control panel.

When you perform problem analysis, you might be instructed to fill out this form so that your hardware service provider can further analyze the problem. There are four forms, one for each of the following partitions:

- Single partition (Models 270 and 8xx)
- Single partition (except Models 270 and 8xx)
- Multiple partitions (Model 8xx)
- Multiple partitions (except Model 8xx)

### Related tasks

"Start problem analysis" on page 9

Follow this procedure to narrow down a problem you are having on your server, and to gather the necessary information to report the problem to your next level of support.

"Collect system reference codes" on page 11

Record the system reference codes on the Problem summary form.

## Problem summary form for single partition (Model 270 and 8xx)

Date and time that the problem occurred: \_\_\_\_\_/\_\_\_\_\_/\_\_\_\_ \_:\_\_:\_\_

Describe the problem: \_\_\_\_\_

| Message ID | Message text | From/send program | Instruction number | To/receive program | Instruction number |
|------------|--------------|-------------------|--------------------|--------------------|--------------------|
| _____      | _____        | _____             | _____              | _____              | _____              |
| _____      | _____        | _____             | _____              | _____              | _____              |
| _____      | _____        | _____             | _____              | _____              | _____              |

1. Record the mode.

2. Place a check on the lines below to indicate which lights on the panel are on. Refer to Control panel for the system units for a diagram of the control panel.

Power On  
 Processor Active/Activity  
 System Attention

3. Go to the system control panel to find and record the value for functions 05, 11, 12, and 13. See "Collect system reference codes" on page 11 for step-by-step instructions on finding System Reference Codes. Use the grid below to record the characters shown on the Function/Data display.

4. Set the same mode as recorded in step 1 of this form.

Comments: \_\_\_\_\_

|    |       |       |       |       |       |       |       |       |       |       |       |       |       |       |       |       |       |       |       |       |
|----|-------|-------|-------|-------|-------|-------|-------|-------|-------|-------|-------|-------|-------|-------|-------|-------|-------|-------|-------|-------|
| 05 | _____ | _____ | _____ | _____ | _____ | _____ | _____ | _____ | _____ | _____ | _____ | _____ | _____ | _____ | _____ | _____ | _____ | _____ | _____ | _____ |
| 11 | _____ | _____ | _____ | _____ | _____ | _____ | _____ | _____ | _____ | _____ | _____ | _____ | _____ | _____ | _____ | _____ | _____ | _____ | _____ | _____ |
| 12 | _____ | _____ | _____ | _____ | _____ | _____ | _____ | _____ | _____ | _____ | _____ | _____ | _____ | _____ | _____ | _____ | _____ | _____ | _____ | _____ |
| 13 | _____ | _____ | _____ | _____ | _____ | _____ | _____ | _____ | _____ | _____ | _____ | _____ | _____ | _____ | _____ | _____ | _____ | _____ | _____ | _____ |
| 20 | _____ | _____ | _____ | _____ | _____ | _____ | _____ | _____ | _____ | _____ | _____ | _____ | _____ | _____ | _____ | _____ | _____ | _____ | _____ | _____ |

### Problem summary form for single partition (except Model 270 and 8xx)

Date and time that the problem occurred: \_\_\_\_/\_\_\_\_/\_\_\_\_ :\_\_:\_\_\_\_

PRM or service request number: \_\_\_\_\_

Describe the problem: \_\_\_\_\_

| Message ID | Message Text | From/Send Program | Instruction Number | To/Receive Program | Instruction Number |
|------------|--------------|-------------------|--------------------|--------------------|--------------------|
| _____      | _____        | _____             | _____              | _____              | _____              |
| _____      | _____        | _____             | _____              | _____              | _____              |
| _____      | _____        | _____             | _____              | _____              | _____              |

- Record the mode.
- Set the mode to Manual.
- Place a check on the lines below to indicate which lights on the panel are on. Refer to Control panel for the system units for a diagram of the control panel.

Power On  
 Processor Active/Activity  
 System Attention

- Press the Increment/Decrement buttons until 11-3 is shown in the Function/Data display. Press the Enter pushbutton.
- Record the 8 characters shown in the Data display for function 11-3.

05 \_\_\_\_\_  
 11xx \_\_\_\_\_  
 12xx \_\_\_\_\_  
 13xx \_\_\_\_\_

14xx \_\_\_\_\_  
 15xx \_\_\_\_\_  
 16xx \_\_\_\_\_  
 17xx \_\_\_\_\_  
 18xx \_\_\_\_\_  
 19xx \_\_\_\_\_  
 20xx \_\_\_\_\_

Some systems will not have the 05 on the Function/Data display.

6. Press the Increment button. This action steps the Function/Data display to the next higher number (12, 13, and so on) and blanks the Data display.
7. Press the Enter pushbutton. This action shows a new set of 8 characters in the Data display. Record this data on the form.
8. Repeat steps 6 and 7 until data has been recorded through function 20. All functions may not be displayed, depending on the failure.
9. Set the same mode as recorded in step 1 on page 32 of this form. Press the Increment/Decrement buttons until the number 11-3 is shown in the Function/Data display. Press the Enter pushbutton. The original system reference code (SRC) appears.
10. Return to the step that sent you here.

Comments: \_\_\_\_\_

### Problem summary form for multiple partitions (Model 8xx)

Date and time that the problem occurred: \_\_\_\_/\_\_\_\_/\_\_\_\_ \_\_\_\_:\_\_\_\_:\_\_\_\_

Partition state: \_\_\_\_\_

Partition ID: \_\_\_\_\_

Partition version: \_\_\_\_\_

Partition release: \_\_\_\_\_

Describe the problem: \_\_\_\_\_

| Message ID | Message Text | From/Send Program | Instruction Number | To/Receive Program | Instruction Number |
|------------|--------------|-------------------|--------------------|--------------------|--------------------|
| _____      | _____        | _____             | _____              | _____              | _____              |
| _____      | _____        | _____             | _____              | _____              | _____              |
| _____      | _____        | _____             | _____              | _____              | _____              |

1. Record the mode.
2. From the Work with Partitions screen, use **Option 10** to set the mode to Manual. For help getting to this screen, refer to Accessing panel functions on a secondary partition.
3. Place a check on the lines below to indicate which lights on the panel are on. Refer to Control panel for the system units for a diagram of the control panel.
  - \_\_\_\_\_ Power On
  - \_\_\_\_\_ Processor Active/Activity
  - \_\_\_\_\_ System Attention
4. On the grid below, record the characters shown on the Display Partition Status screen for functions 05, 11, 12, 13. In the product activity log and other software displays, the System Reference Code (SRC) appears much like it does for earlier releases. One difference is that the first word will have up

to 32 characters of text. Another difference is that the word will be a number from 1 to 9 instead of 11 to 19. This helps to avoid confusing the word number with the function number used to find it.

- Go to the system panel to find and record the value for function 20. See "Collect system reference codes" on page 11 for step-by-step instructions.

### Problem summary form for multiple partitions (except Model 8xx)

Date and time that the problem occurred: \_\_\_\_\_/\_\_\_\_\_/\_\_\_\_ \_:\_\_:\_\_\_\_

Partition state: \_\_\_\_\_

Partition ID: \_\_\_\_\_

Partition version: \_\_\_\_\_

Partition name (optional): \_\_\_\_\_

Partition release: \_\_\_\_\_

Describe the problem: \_\_\_\_\_

| Message ID | Message Text | From/Send Program | Instruction Number | To/Receive Program | Instruction Number |
|------------|--------------|-------------------|--------------------|--------------------|--------------------|
| _____      | _____        | _____             | _____              | _____              | _____              |
| _____      | _____        | _____             | _____              | _____              | _____              |
| _____      | _____        | _____             | _____              | _____              | _____              |

- Record the mode.
- From Work with Partitions screen, use option 10 to set the mode to Manual. For help getting to this screen, refer to Accessing panel functions on a secondary partition.
- Place a check on the lines below to indicate which lights on the panel are on. Refer to Control panel for the system units for a diagram of the control panel.

\_\_\_\_\_ Power On

\_\_\_\_\_ Processor Active/Activity

\_\_\_\_\_ System Attention

- Record the 8 characters shown in the Display Partition Status screen for Reference Codes 11x through 19xx.

05 \_\_\_\_\_

11xx \_\_\_\_\_

12xx \_\_\_\_\_

13xx \_\_\_\_\_

14xx \_\_\_\_\_

15xx \_\_\_\_\_

16xx \_\_\_\_\_

17xx \_\_\_\_\_

18xx \_\_\_\_\_

19xx \_\_\_\_\_

20xx \_\_\_\_\_

- Go to the system control panel to find and record the value for the 20xx Reference Code.
- Set the same mode as recorded in step 1 of this form.
- Return to the step that sent you here.

Comments: \_\_\_\_\_



## Contact IBM support

This topic provides information that you can use to obtain services and support for your iSeries business computing system.

In general, the term service includes repair of hardware, the ability to ask usage and defect questions about your software, and on-site and remote support for any system concerns through IBM Services.

| Type of problem  | Call  |
|--|---|
| <ul style="list-style-type: none"><li>• Advice</li><li>• Migrating</li><li>• "How to"</li><li>• Operating</li><li>• Configuring</li><li>• Ordering</li><li>• Performance</li><li>• General information</li></ul>   | <ul style="list-style-type: none"><li>• 1-800-IBM-CALL (1-800-426-2255)</li><li>• 1-800-IBM-4YOU (1-800-426-4968)</li></ul> |
| <p><b>Software:</b></p> <ul style="list-style-type: none"><li>• Fix information</li><li>• Operating system problem</li><li>• IBM application program</li><li>• Loop, hang, or message</li></ul> <p><b>Hardware:</b></p> <ul style="list-style-type: none"><li>• IBM system hardware broken</li><li>• Hardware system reference code (SRC)</li><li>• IBM input/output (I/O) problem</li><li>• Upgrade</li></ul> | 1-800-IBM-SERV (1-800-426-7378)   |

When reporting suspected software problems, you need to provide the following information.

### Contact information:

Send the following information about you and the system you are using:

- Name of person reporting the problem
- Mailing address
- Telephone number
- FAX number
- IBM customer number, if available
- Server type and serial number

### Problem description:

Include the following information when describing the problem you are experiencing with your system:

- The name of the software product you are using, including the version and release
- The cumulative PTF level of the system
- The problem symptom
- Message numbers, messages, and return codes associated with the problem
- A list of the steps needed to re-create the problem
- A list of any actions you have already taken

- A copy of the job log

### **Additional information for communications problems:**

If the problem you are experiencing is related to a communications error, include the following information:

- Identify all systems and locations involved in the problem
- Identify the communications method and connection used between the systems
- Collect messages from all systems that are involved in the problem
- Identify any recent changes or upgrades that have been made to any of the involved systems

### **Additional information for iSeries Access problems:**

If the problem you are experiencing is related to the iSeries Access products, provide the following additional information:

- All systems and locations involved in the problem
- The topology between iSeries and the client system
- The functions of iSeries Access that you are using
- All resources that are involved
- The operating system of the client system
- Any major applications that are affected by the problem
- Hardware attachments involved in the problem
- Any recent changes or upgrades to any involved system
- Any messages logged in QSYSOPR or on the client system

#### **Related reference**

Directory of Worldwide Contacts

## **Report problems detected by the system**

The system problem log allows you to display a list of all the problems recorded on the system.

You also can display detailed information about a specific problem. For example, you can see the product type and serial number of the device that had the problem, the date and time of the problem, the part that failed, where the part is found, and the problem status. You can also analyze and report a problem, or determine any service activity.

To report a problem that has an entry in the problem log, perform the following steps:

1. Type WRKPRB on any command line and press Enter. The Work with Problems (WRKPRB) display appears.
2. If you have a problem ID, look for an entry with the same ID on the Work with Problems display. Select option 8 (Work with problem) for the problem you want to work with and press Enter. The Work with Problem display appears.
3. Select option 2 (Report problem) and press Enter. The Verify Contact Information display appears.
4. To change any fields that appear, type over the current information and press Enter. The system includes the new information in the service request.
5. Select the severity level that closely relates to the severity of your problem on the Select Problem Severity display.
6. Select who should receive and process your request on the Select Service Provider display.
7. Select when and how you want to send the service request on the Select Reporting Option display.
8. Choose from the following options:

- To report the problem automatically, continue with Report problems automatically.
- To report the problem by voice, perform the following steps:
  - a. Select option 3 (Report service quest by voice). The telephone number of the service provider for your specific problem will display. If the service provider is IBM, a service number will be assigned to the problem.
  - b. To put this number in the problem log, press F14 (Specify service-assigned number).

## Report problems automatically

The automated problem analysis function runs problem analysis routines automatically when the system detects a problem.

The problem reporting function notifies the service provider of the software problem. To run these functions, the appropriate service attributes must be set to \*YES. If these attributes are set to \*NO, you will need to run the problem analysis manually. The default value for service attributes is \*NO.

Use the Display Service Attribute (DSPSRVA) command to display the service attributes, or use the Change Service Attributes (CHGSRVA) command to change the service attributes.

To change service attributes, fill in the appropriate information in the fields. Specify \*YES in the Analyze problem field to automatically run problem analysis at the time of the failure. Problem analysis includes programs that attempt to isolate or correct the problems. Automated problem analysis applies mostly to hardware problems, and some software problems in Licensed Internal Code. To determine which problems are analyzed automatically and which ones are not, use the Work with Problem (WRKPRB) command. If the status is Opened, it indicates that the problem has not been analyzed. For problems that are not analyzed automatically, you can use the Work with Problems (WRKPRB) command to run the problem analysis manually. Go to “Use the Work with Problems (WRKPRB) command” on page 58 for detailed information about the command. “Examples: Work with Problems (WRKPRB) command” on page 58 provides you examples of how the command is used.

When \*YES is specified in the Report problem automatically field, software problems are reported automatically to the service provider. Your service provider is specified in the Control point name field. For hardware problem reporting, contact your service provider.

### Related tasks

“Use the Analyze Problem (ANZPRB) command” on page 54

Use the Analyze Problem (ANZPRB) command to start problem analysis for user-detected problems.

## Track problems

You can use several methods to manage your reported problems.

### Query problem status

To find the latest status of a reported problem.

To retrieve the latest status of a previously reported problem, there are two methods available to use.

### Related concepts

“Report problems: Overview” on page 31

Use this information to learn what information you should gather about your problem, how to report and track problems, and how to send a service request.

### Method 1:

Find the latest status of a reported problem using QRYPRBSTS.

1. Type QRYPRBSTS on any command line, and press the F4 key. The Query Problem Status (QRYPRBSTS) display appears.

**Note:** Currently, the QRYPRBSTS command is not enabled to query hardware problems.

2. If you know the problem management record (PMR) number, type \*PMR in the **Problem identifier** field and press the Enter key. Additional fields appear on the display. Type the PMR number in the **Service number** field and press the Enter key. If you know the WRKPRB problem ID number, type the 10-digit ID number for the problem in the **Problem identifier** field and press the Enter key. If you don't know the problem ID number, see "Finding a previously reported problem" in the "Related topics" section for instructions on how to find this 10-digit number.
3. After the query is complete, enter: WRKPRB xxxxxxxxxx (where xxxxxxxxxx is the 10-digit problem ID number). The Work with Problem display appears.
4. Type option 12 (Enter text) next to the problem entry and press Enter. The Select Text Type display appears.
5. Select option 10 (Query Status text). The Query results are shown.

### Method 2:

Find the latest status of a reported problem using WRKPRB.

1. Type WRKPRB on any command line and press the Enter key. The Work with Problems display appears.
2. Find the problem entry for which you want to query the status. To start a query, the problem entry must have a status of Answered or Sent.
3. Type option 8 (Work with problem) next to the problem entry. The Work with Problem menu appears.
4. Select option 41 (Query problem status text). The Results of the query are shown.

**Note:** The QRYPRBSTS command does not apply to problem entries that have a Fix request specified in the problem description column of the Work with Problem display.

### Find a previously reported problem

Learn about how to find a previously reported problem.

To find a previously reported problem, you need to know the IBM Service-assigned number, also known as the Problem Management Record (PMR) number.

After you have this number, type the following command on any command line:

```
WRKPRB SRVID(XXXXX)
```

where XXXXX is the PMR number, then press the Enter key.

If you do not have the PMR number, "Use the Work with Problems (WRKPRB) command" on page 58 and search the list for the problems with a status of SENT, VERIFIED, ANSWERED, and CLOSED.

### Add notes to a problem record

Learn about how to attach a note or add notes to an existing note in the problem record.

To attach a note or add to an existing note in the problem record, perform the following steps.

1. Use the Work with Problem (WRKPRB) command.
2. Select option 12 (Enter text) on the Work with Problems display. The Select Text Type display appears.
3. Select option 1 (Problem description) to enter problem description. Only the text that is entered with this option is sent to the service provider along with the problem.

Notes should be typed in the following format to keep a chronological record of events.

- On the first line, type a brief description of the problem.
- On the second line, type the current date.

- On the third line, type in the note that you want to send. Use as many additional lines (up to 20) as you need.

Include the following information in your notes:

- Any recent release update that you have applied to the system
- Any changes you made in the system configuration
- Any new program or feature that you are using
- Anything that might be different since the last time the program, feature, or device ran without a problem

---

## Reference information

Use this information to learn more about messages, message queues, logs, CL commands, problem-handling menus, Authorized Program Analysis Reports (APARs), and how to determine the primary or alternative console.

### Details: Messages

Use this topic to find out details on the types of messages and the ways to manage messages.

#### Related concepts

“Messages” on page 3

Messages are communications that are sent from one person or program to another.

### Types of messages

There are a variety of system and server messages available to assist you, ranging from error messages, to printer messages, to alerts.

The system is shipped with the IBM-supplied message files, stored in the system library, QSYS: the CPF message file, QCPFMSG (for the i5/OS system and machine interface messages); and the licensed program message files, such as QRPGMSG (for RPG messages). It is important before you handle messages to understand the message types:

- Error messages can indicate simple to complex system, device, or program errors.
- Alerts provide analysis on hardware or software resources.

#### Related reference

CL Programming

### Error messages:

A variety of system messages can indicate conditions that range from simple typing errors to problems with system devices or programs.

Error messages can be sent to a message queue or to a program and shown on a display. Messages might be one of the following messages:

- An error message on your current display
- A message regarding a system problem that is sent to the system operator message queue, QSYSOPR
- A message regarding a device problem that is sent to the message queue specified in a device description
- A message regarding a potential severe system condition that is sent to the QSYSMSG message queue, the system operator message queue, and other message queues specified by the users
- An unexpected error message that is not handled by a program (shown on the Display Program Messages display)

*Use error messages:*

Use error messages to help you fix the errors.

If you request a task that the system cannot run because of an error, an error message appears at the bottom of the display. Depending on the display, the keyboard might also lock. To unlock the keyboard, press the Reset key.

**Note:** Displays of some application programs might not have message lines on the bottom of the display.

To obtain additional information about the error, take the following steps:

1. Move the cursor to the same line as the message. If you cannot move the cursor, go to Step 2.
2. Use option 5 (Display details and reply) to display additional information about the message. Press F9 to see message details such as the program and its instruction number causing the error. You might need to contact the owner of the program to fix the problem described in the error message.

#### **Related tasks**

*“Messages in a Message Queue”*

Use messages in a message queue to run problem analysis.

*Examples: Use error messages:*

### **Example 1**

The system sometimes sends error messages that require you to respond or select from a group of options. Based on the possible choices given (always in parentheses), this is generally a one-character response.

For example, notice the five possible choices for this message:

```
Verify alignment on device PRT01. (I C G N R)
```

Messages of this kind with possible choices most often appear on the system operator message queue. However, under certain circumstances, they can also appear on your own message queue.

You aren't expected to know or remember the meanings of the numbers or letters in any reply. The Additional Message Information display provides information about each choice. In addition, this display also provides a reply line on which you can type your reply (if a reply is needed).

### **Example 2**

Suppose that you want to print a finished report. You send it to the printer, but it doesn't print. You check your message queue and find the following message:

```
End of forms on printer PRT01. (C H I PAGE 1-99999)
```

The computer wants you to reply, using one of the four choices that are shown (C H I PAGE 1-99999).

To get to the Additional Message Information display from the Work with Messages display (the basic assistance level), follow these steps:

1. Position the cursor on the option line in front of the message you want to respond to.
2. Select **option 5** (Display details and reply).
3. When the Additional Message Information display appears, page down through the information to find the description of each reply value.

*Messages in a Message Queue:*

Use messages in a message queue to run problem analysis.

Some messages allow you to run problem analysis. This helps you resolve an error that you cannot resolve from the message or the Additional Message Information display. These messages have an asterisk (\*) in front of them (intermediate assistance level) or are highlighted (basic assistance level).

- Basic assistance level: Shows the Work with Messages display. Press **option 5** to show the Additional Message Information display.
- Intermediate assistance level: Shows the Display Messages display. You can position the cursor to the message and press Help to show the Additional Message Information display.

**Note:** Messages about critical system errors or conditions are reverse-imaged (intermediate assistance level), or highlighted (basic assistance level). You can run problem analysis on the messages with an asterisk (\*) in front of them or if F14 is shown on the Additional Message Information display.

To analyze problems from the intermediate assistance level:

1. Move your cursor to any message with an asterisk and press F14.
2. From the Work with Problem (WRKPRB) display, you can display the details of the problem and work directly with the problem.

To run problem analysis from the basic assistance level for messages that are highlighted, select **option 5** (Display details and reply) for that message and press F14 (Work with problem).

#### **Related tasks**

“Use error messages” on page 39

Use error messages to help you fix the errors.

#### **Alerts:**

An alert is a message that has several benefits.

An alert is automatically sent from any system in the network to the system that is designated to manage problems.

An alert provides a quick, initial assessment of a problem and gives the network operator guidance on corrective actions. For those problems that a network operator cannot correct, the alert provides information that a specialist can use to isolate the source of the problem.

Alerts inform the operator of problems with hardware resources, such as local devices or controllers, communications lines, or remote controllers or devices. Alerts can also notify the operator of software errors that are detected by the system or application programs. If the system is part of a communications network, alerts can be created and sent through the network to the problem-managing system.

You can use alerts to perform the following management activities:

- Monitor systems and devices that operate unattended.
- Manage situations in which the local operator does not know how to handle the problem.
- Maintain control of system resources and expense.

#### **Benefits of alerts**

Use alerts to manage your network and systems more effectively.

The following situations are examples of when you might use alerts.

- To reduce your system and network costs. Because the system automatically controls the capabilities of alerts, you can automate common responses to system problems without operator intervention.
- To monitor your network status. Alerts provide information about specific network problems that can help you track and monitor your system.

- To monitor unattended remote systems. Alerts can notify a central site about a problem on an unattended system.
- To have all your technical people at one location. When you use alerts, you can staff all of your technical support at one central site.
- To make your own applications have the same error-reporting capabilities as the system functions. Alerts give you the capability to define your own alertable messages.
- To provide the ability to choose where your technical support is located. When you use alerts, you can select which of your systems receive central technical support.
- When you manage a network with either homogeneous or heterogeneous systems. Because alerts are designed to be independent of the system architecture, alerts from one system are readable on other systems.

#### **Related tasks**

##### *“Display alerts”*

You can log and display alerts that were either locally created on your system or that were received from other systems in the network. Your system does not need to be actively processing alerts to work with alerts. You can see all the alerts that are logged in the alert database.

#### **Display alerts:**

You can log and display alerts that were either locally created on your system or that were received from other systems in the network. Your system does not need to be actively processing alerts to work with alerts. You can see all the alerts that are logged in the alert database.

To view the logged alerts:

1. Use the Work with Alerts (WRKALR) command. Type WRKALR and press Enter from any command line. The most recent alert is displayed first.
2. Type 5 to display the recommended actions.
3. Type 8 to display the details for a specific alert.

To refresh the list of alerts automatically, press F21 (Automatic refresh).

#### **Related concepts**

##### *“Alerts” on page 41*

An alert is a message that has several benefits.

## **Manage messages**

You can manage messages in different ways.

#### **Display messages:**

From the iSeries Navigator window, you can display messages in the system-operator (QSYSOPR) or user-message queues.

Messages in these queues include information from the operating system and other users.

To display a message, follow these steps:

1. From the iSeries Navigator window, expand the server from which you want to work.
2. Expand **Basic Operations**.
3. To display messages for the server that you selected, click **Messages**. This displays all the messages for your user profile.
4. From the menu bar, select **Options** → **Include**.
5. Click the button at the right of the **Messages for** field to display the **Messages for** dialog box.



6. Select the appropriate option to display messages for the current user, the system operator, or another user's message queue.

**Note:** If you want to display messages for another user's queue, you must specify the user name. To see a list of all users on the system, click **Browse** → **select the user name from the list shown to display the message queue**.

7. Click **OK** to return to the Include dialog box.
8. (Optional) You can limit the messages that are displayed by severity. Severity ratings numerically identify the extent of a problem. To display messages with a minimum severity rating (0-99), enter a specific numeric value in the **Lowest severity to show** field.
9. Click **OK** to save your changes and close the Include dialog box.

#### *Display message details:*

From the iSeries Navigator window, you can display the details or properties of your messages.

This provides you with message information that includes:

#### **Details from the file menu that shows you:**

- Message ID
- Date and time sent
- Message text
- Message help (cause and recovery)

#### **Properties from the File menu that shows you:**

- Who sent the message
- Message text
- Date and time sent
- Message ID
- Severity level
- Message type
- Name of message queue
- Message queue library
- Name of the job that sent the message
- Number of jobs that sent the message
- Name of the program that sent the message

To display the details of your messages, follow these steps:

1. From the iSeries Navigator window, select the message for which additional detail is wanted.
2. Choose from the following options:
  - For cause and recovery information, select **File** → **Details**.
  - For information about the sender of the message, the message type and severity level, and the message queue, select **FileProperties**.

#### *Display messages in the QSYSMSG queue:*

The QSYSMSG message queue is used to handle potentially severe system messages, which are messages that require immediate action.

To display the messages in QSYSMSG, follow these steps:

1. Type `WRKMSG QSYSMSG`, the Work Messages command for message queue `QSYSMSG`, at the command line. This command shows all messages in the `QSYSMSG` queue.
2. For more information about a message, move the cursor to the same line as the message.
3. (Optional) If you do not have your Assistance Level specified as Basic, press F21. Select option 1=Basic. If you do not have your system set to the basic assistance level, you cannot display the message details.
4. To show the Additional Message Information display, select option 5.
5. To display message details, select F9. This display shows the time that the user sent the message. This also displays the name of the users or programs that sent and received the message.

**Note:** These instructions also display messages in any message queue.

### Send messages:

Whether you are a system operator or user, you can communicate between servers by sending messages.

To send a message, follow these instructions:

1. From the iSeries Navigator menu bar, select **File** → **Send Message**.
2. In the Send to field, enter or select the name of the user or workstation who will receive the message.
3. Select **Request a reply** if you want a reply to your message.
4. Select **Interrupt user** to interrupt a user with your message.
5. Type your message in the Message text field.

### Respond to messages:

From the iSeries Navigator window, you can reply to inquiry messages.

This allows you to respond to messages from the system operator or other users.

To reply to your messages, follow these steps:

1. From the iSeries Navigator window, select the inquiry message in the message list to which you want to reply.
2. From the menu bar, select **File** → **Reply**.
3. Type your reply.
4. Click **Reply**.

### Respond to printer messages

The system operator and users can receive and display messages from system programs that communicate system conditions.

This function includes receiving messages about printing. Each printer has a Details: Message queues message queue. The printer can stop printing to wait for a response to a message. This allows the system operator to manage and report problems regarding the print devices.

To display printer messages for which a response is required, follow these steps:

1. To show the Work with Printers display, type `WRKWTR ASTLVL (*BASIC)` at the command line.
2. To display printer messages for which a response is required, select option 7 (Printer message).
3. In the reply field, type your response to the printer message.

#### Related concepts

### “Details: Message queues”

Use this topic to find out details on the different types of message queues and the several ways to manage message queues.

#### **Remove messages:**

From the iSeries Navigator window, you can remove any unneeded messages.

The message queue stores messages from the system operator, system programs, and other users on the system.

To remove the appropriate messages, follow these steps:

1. From the iSeries Navigator window, expand the system from which you want to remove messages.
2. To display the messages for your user profile, click **Messages**.
3. Select the message that you want to remove from the message queue.
4. From the menu bar, select **File** → **Delete**.
5. To complete the removal of your messages, click **Delete** on the Confirmation dialog box.

#### **Print messages:**

Messages help you track your system’s problems and user activities.

To help you organize system messages, you can print the specific messages that refer to the current problem that you are handling.

To print specific messages one at a time from the message queue, follow these steps:

1. Enter the Work with Messages (WRKMSG) command, at the command line.
2. Press F4 to prompt.
3. In the message queue parameter field, enter the name of the message queue that contains the messages that you want to print.
4. Press Enter to continue.
5. (Optional) If you do not have your Assistance Level specified as Basic, press F21. Select option **1=Basic**. If you do not have your system set to the basic assistance level, you cannot display the message details.
6. To display the message that you want to print, enter 5 (Display details) and reply in the Options column.
7. To print the message, press F6.

You can also track your systems problems by printing all messages in the message queue.

#### **Related tasks**

“Print all messages in the message queue” on page 49

Sometimes a problem has many messages associated with it.

## **Details: Message queues**

Use this topic to find out details on the different types of message queues and the several ways to manage message queues.

#### **Related concepts**

“Message queues” on page 4

A message queue is like a mail box for messages.

“Respond to messages” on page 44

From the iSeries Navigator window, you can reply to inquiry messages.

## Types of message queues

You can use several system queues to receive messages.

The system queues that you can use are as follows:

- The system operator message queue, QSYSOPR contains system messages that require a reply from the operator.
- Optional message queue QSYSMSG holds several error messages.
- The history log, QHST holds messages that track the system's activities.
- The printer queue stores messages that are associated with each printer.
- Each user and workstation also has message queues that hold messages from the system operator, another user, or system.

## QSYSOPR message queue

The system operator message queue, QSYSOPR, contains system messages that require a reply from the operator.

To handle the large number of messages that are sent to QSYSOPR, or the configured message queue, a **message queue parameter (MSGQ)** exists for the following line and controller descriptions:

- Line descriptions: Distributed Data Interface, Ethernet, Frame-Relay, token-ring, X.25
- Controller descriptions: APPC, Async, Local Workstation, Remote Workstation, SNA Host, Virtual Workstation

### Related tasks

“Display the contents of the QHST history log” on page 52

Track your system activities by displaying the contents of the history log, QHST.

“Change the message queue for a printer” on page 49

You can change the location of the message queue that stores messages that are associated with each printer. Changing this location allows you to separate your printing messages from system, user, or error messages.

### Related reference

“Create message queue QSYSMSG for severe messages” on page 48

You can create an optional message queue, QSYSMSG, to hold specific severe system messages.

## Manage message queues

You can manage your message queues in several ways.

The operations you can use to manage your message queues include:

- Create message queues
- Change the attributes of message queues
- Change the message queue for a printer
- Print all messages in the message queue

The following details are how these examples can be implemented using the MSGQ function.

- You are a small-sized customer who has one LAN line and very few users: There are no changes that need to be made; all messages will remain in QSYSOPR, or the configured message queue.
- You are a medium-sized customer who has a couple of LAN lines: In this instance, you will need to change the QCFGMSGQ system value to the system-supplied message queue, QSYS/QCFGMSGQ. As a result, all communications messages for the object types that support the MSGQ configuration parameter will go to this one queue.

- You are a large-sized customer who has many LAN lines and many WAN lines, with many users on each line. You want to set up the message queues so that messages are separated as the following ways:
  - The messages for the Ethernet LAN will go to ETHMSGQ: On this line, the system configures all the controllers automatically.
  - The messages for the token-ring LAN will go to TRNMSGQ: On this line, the system configures most controllers; however, some controllers must be configured manually.
  - All messages for workstation users will go to the WSMMSGQ: This includes local workstations, remote workstations, pass-through, and telnet.
  - All other communications messages will go to QCFGMSGQ.
- You are an experienced operator who has written a program that helps the operator know which message queues are the important ones. Here is how to configure this example:
  - Change the system value QCFGMSGQ to QSYS/QCFGMSGQ.
  - Create the Ethernet line description with MSGQ(ETHMSGQ): The system creates all controllers (and thus devices) on this line. This means the system will send their messages to the message queue defined in the line ETHMSGQ.
  - Create the token-ring line description with MSGQ(TRNMSGQ): The automatically created controllers and devices on this line will have their messages sent to TRNMSGQ. Controllers that are manually created on this line are created with the MSGQ(TRNMSGQ) parameter.
  - Create the X.25 line description with MSGQ(V25MSGQ): All controllers that are created for this X.25 line description must be created using the MSGQ(X25MSGQ) parameter on the CRTCTLxxx command.
  - You can set up the workstation controller descriptions as the following ways:
    - The local workstation controller, which the system automatically created, was changed to MSGQ(WSMMSGQ).

**Notes:**

1. Create all printer devices attached to the workstation controller with MSGQ(\*CTLD). Messages for display devices always go to the message queue that is defined in the associated controller. Thus, changing the message queue of the controller results in the messages for the devices that go to the messages queue defined in the controller description.
  2. It is possible for the user to use a CHGCMDDFT command and have the message queue default to a different queue. This means that the automatic creation of the local workstation controller will use the different message queue.
    - Create the virtual controllers for pass-through and Telnet with MSGQ(WSMMSGQ).  
Like the local workstation controllers above, the devices attached to the virtual workstation controllers will have their messages sent to the queue defined in the virtual controller. The same logic works for remote workstation controllers and their attached devices.
- You are a large-sized customer that is now only using TCP/IP and want to have the line and workstation messages logged to the QTCP message queue: You can manage this configuration by changing the system value QCFGMSGQ to QSYS/QTCP.

**Create message queues:**

You can create message queues to store messages within a particular library.

The message queue provides you a place to receive and store informational and inquiry messages efficiently.

To create a message queue, follow these steps:

1. From the i5/OS Main Menu, select **option 3** (General system tasks).

2. From the General Systems Tasks display, select **option 4** (Messages).
3. From the Messages display, select **option 7** (Create a message queue).
4. In the **Message Queue Parameter** field, enter the name of the new message queue.
5. To specify additional message queue characteristics, press F10 (Additional Parameters). You can specify the following characteristics:
  - Place all message queue changes into auxiliary storage. This includes changes to the message queue attributes and changes due to messages that are sent or removed from the queue.
  - Specify the message queue size.
  - Specify user authority.
  - Specify whether the message queue allows the system to generate an alert.
  - Specify the coded character set ID (CCSID).

**Note:** For further information about parameters and keywords that allow you to specify message queue characteristics, press F1 for each keyword.

**Related reference**

“Create message queue QSYSMSG for severe messages”

You can create an optional message queue, QSYSMSG, to hold specific severe system messages.

**Create message queue QSYSMSG for severe messages:**

You can create an optional message queue, QSYSMSG, to hold specific severe system messages.

QSYSMSG holds only messages that require immediate action.

To create QSYSMSG, type CRTMSGQ QSYS/QSYSMSG TEXT ('OPTIONAL MSGQ TO RECEIVE SPECIFIC SYSTEM MESSAGES') at the command line and press Enter. The system then creates the message queue.

After you create the QSYSMSG message queue, your system stores specific system messages in it.

**Example:** CPF0907 Serious storage condition might exist. Press **HELP**.

**Related concepts**

“Types of message queues” on page 46

You can use several system queues to receive messages.

**Related tasks**

“Start problem analysis” on page 9

Follow this procedure to narrow down a problem you are having on your server, and to gather the necessary information to report the problem to your next level of support.

“Create message queues” on page 47

You can create message queues to store messages within a particular library.

**Change the attributes of message queues:**

Your server has several message queues that hold messages with helpful information for finding and reporting problems.

You can customize the way that a message queue notifies you of messages.

To change the attributes of a message queue, follow these steps:

1. Enter the Change Message Queue command (CHGMSGQ) at the command line.
2. Press F4 to prompt.
3. Enter the name of the message queue that you want to change in the MSGQ parameter field.

4. Enter the name of the library that contains the message queue in the message queue library field.
5. To change the delivery notification, specify the delivery (DLVRY) parameter.

**Note:** To view a list of values for the delivery parameter, press F1.

6. Press F10 for additional parameters.
7. To limit message delivery by severity codes, specify the numeric value that you want to view in the field of the Severity code filter, SEV, parameter field.

### **Change the message queue for a printer:**

You can change the location of the message queue that stores messages that are associated with each printer. Changing this location allows you to separate your printing messages from system, user, or error messages.

To change the location of the message queue that stores printer messages, follow these steps:

1. To display a list of printers, at the i5/OS Main Menu type WRKDEVD \*PRT at the command line. Press Enter.
2. Enter 2 (Change) in the Opt column, next to the print device that is changing.
3. From the Change Device Description display, specify the name of the message queue that you want to change in the message queue parameter field.

#### **Related concepts**

“Types of message queues” on page 46

You can use several system queues to receive messages.

### **Print all messages in the message queue:**

Sometimes a problem has many messages associated with it.

To help you organize messages that are reporting possible problems, you can print the message from a message queue.

To print messages from a message queue, follow these steps:

1. From the i5/OS Main Menu, select option 3 (General Systems Tasks).
2. From the General Systems Tasks display, select option 4 (Messages).
3. From the Messages display, select option 3 (Display Messages).
4. In the Message queue parameter field, enter the name of the message queue that contains the messages which you want to print.
5. In the library parameter field, specify the library where the message queue resides.
6. In the Output parameter field, enter the value, \*PRTWRAP.
7. (Optional): To quickly print messages, type DSPMSG MSG(MSQNAME) OUTPUT(\*PRTWRAP) at the command line.

#### **Related tasks**

“Print messages” on page 45

Messages help you track your system’s problems and user activities.

## **Details: Logs**

Use this topic to find out details on the different log types.

- Job logs
- History logs
- Problem logs

### **Related concepts**

“Logs” on page 4

The i5/OS licensed program records certain kinds of events and messages for use in diagnosing problems.

### **Job logs**

Every job that runs on your server has an associated job log that records its activities.

A job log can contain the following information:

- The commands in the job
- The commands in a CL program
- All messages associated with that job

You can control the content of the job log by using the value specified on the LOG parameter, see Control the content of the job log. You can specify the LOG parameter on the CHGJOB, CHGJOBDB, or CRTJOBDB commands.

To display job logs, go to Display job logs.

### **Related concepts**

“History logs” on page 52

The history log is a tool that contains information about the operation of the system and the system status.

### **Related information**

Job logs and communication problems

### **Control the content of the job log:**

When working with problems, you might want to record the maximum amount of information for jobs that have frequent problems.

Alternatively, you might not want to create a job log for jobs that were completed normally. Or, you might want to exclude informational messages.

To control the contents of the job log by using the Create Job Description (CRTJOBDB) command:

1. Type CRTJOBDB from any command line and press F4.
2. Find the message logging (LOG) parameter, and specify the appropriate values for the following parameters:
  - The message level.
  - The message severity.
  - The message text level.
3. Complete the values for the required parameters and press Enter.

*Details: Control the content of the job log using the message level value:*

The message level value controls the type and number of messages that the system writes to a job log.

The message level can be one of the following levels:

- 0 No data is logged.
- 1 The messages that are logged are only those that are sent to the external message queue for the job with a severity greater than or equal to the specified message severity.
- 2 Logs all level 1 messages, and the following information:



- Any requests that result in a high-level message with a severity level that exceeds or equals the message severity specified.
  - If a request is logged, all of its associated messages are also logged.
- 3 The same as level 2, and the following information:
- All requests.
  - Commands that are run by a CL program if allowed by the log CL program command's job attribute and the log attribute of the CL program.
- 4 The following information is logged:
- All requests or commands that are logged from a CL program.
  - All messages with a severity at least equal to the specified severity. This includes trace messages.
  - Commands that are run by a CL program if allowed by the log CL program command's job attribute and the log attribute of the CL program.

**Note:** A high-level message is one that is sent to the program message queue of the program that receives the request. For example, QCMD is an IBM-supplied request processing program that receives requests.

*Details: Control the content of the job log using the message severity value:*

The message severity determines which messages are logged.

Every message has an associated severity. For example, informational messages have a severity of 00. Messages that are essential to the operation of the system have a severity of 99, which is the highest severity. For more information, see the online help.

*Details: Controlling the content of the job log using the message text level value:*

You can request to have a variety of message text generated.

The amount of message text depends on the values that you specify for the message text level.

- Specify \*MSG to write only the message text to the job log.
- Specify \*SECLVL to write both message text and message help to the job log.
- Specify \*NOLIST if you do not want to create a job log when a job ends normally.

### **Display job logs:**

To analyze a problem, you might want to review the messages in the job log. You can display a job log in several different ways.

The job log contains the messages that were recorded when a job ran. You can review these messages to analyze the problems. You have several different ways to display a job log. How you display the job log depends on whether the job has ended or is still running.

- For a job that has ended, use the Work with User Jobs display.
  1. Type WRKUSRJOB from any command line.
  2. Select option 8 (Work with spooled files) for the job whose log you want to see.
  3. Find the file that is called QPJOBLOG on the Work with Spooled Files display.
  4. Type 5 (Display) to view it.
- For a job that is still running, use the Work with User Jobs display.
  1. Type WRKUSRJOB from any command line.
  2. Type 5 (Work with) for the job whose log you want to see.

3. Type 10 (Display job log, if active or on job queue) from the Work with Job display.
- To display the job log for your own workstation session, use the Display Job Log (DSPJOBLOG) command. Type DSPJOBLOG from any command line.

## History logs

The history log is a tool that contains information about the operation of the system and the system status.

The history log tracks high-level activities such as the start and completion of jobs, device status changes, system operator messages, and security violations. The information is recorded in the form of messages. These messages are stored in files that are created by the system.

History logs help you track and control system activity. When you maintain an accurate history log, you can monitor specific system activities that help analyze problems. History logs differ from job logs. Job logs record the sequential events of a job. History logs record certain operational and status messages that relate to all jobs in the system.

You can start your investigation of a problem by looking at the history log and then referring to a specific job log for details.

### Related concepts

“Job logs” on page 50

Every job that runs on your server has an associated job log that records its activities.

### Related tasks

Display the Product Activity Log to solve communication problems

## Display the list of history log files:

Use the Display Object Description (DSPOBJD) command to view a list of history log files.

The history log files are copies of all the messages that are sent to the message queue QHST. When the size of the current history log exceeds its size limitation, the system creates a new file. The files reside in library QSYS and begin with the letters QHST, followed by a number. The format that is used is QHSTyydddnn. The yydddnn represents the date of the first message in the file, where yy is the year and ddd is the sequential number of the day of the year (for example, February 1 would be 032). The n that is appended at the end is a sequence number; this sequence number is only incremented when more than one QHST file is generated within one day.

To display the list of history logs and to view its contents:

1. Type WRKF QHST\* from any command line.
2. Select option 5 to display the contents of the file.

**Note:** The system copies the messages in the QHST message queue to the history log files and then removes them from the QHST message queue. The DSPLOG command uses the history log files to show the messages sent to the QHST message queue.

## Display the contents of the QHST history log:

Track your system activities by displaying the contents of the history log, QHST.

QHST contains past system operator messages, device status, job status changes, and program temporary fix activities that are stored as system messages.

1. To display the contents of the QHST history log, type the Display Log command (DSPLOG) at the command line.
2. To prompt the command, select F4.

3. To display only messages that were logged during a certain time, specify a time period. If you did not specify a time period, the DSPLOG command displays all available messages for that day.

#### **Related concepts**

“Types of message queues” on page 46

You can use several system queues to receive messages.

## **Problem logs**

A problem log is a useful tool for coordinating and tracking all your problem management operations.

The problem log at a service provider contains problem records created as a result of:

- Incoming alerts that were received
- Service requests and Program Temporary Fix (PTF) orders that were received
- Local system-detected problems
- Local user-detected problems

You can print or display error logs from your jobs.

#### **Print error logs:**

If you have errors, you might want to print the error log.

Your log contains a list of errors that occurred on your system. When you review these errors, you might be able to determine the problem.

To print the error log:

1. Type PRTERLOG from any command line and press F4.
2. Type the parameter value for the kind of error log information that you want to print. For example, you can specify \*ALL to print all the error codes, or specify \*ALLSUM to print a summary of the error log.
3. Press Enter. The error log information is sent to the output queue that is identified in your user profile.
4. Type GO ASSIST from any command line to display the Operational Assistant menu.
5. Type 10 (Start printing) on the Work with Printer Output display to print the error log.

#### **Related tasks**

“Display error logs”

If you have errors, you might want to display the error log. Your error log contains a list of errors that occurred on your system.

#### **Display error logs:**

If you have errors, you might want to display the error log. Your error log contains a list of errors that occurred on your system.

When you review these errors, you might be able to determine the problem.

To view the error log:

1. Type PRTERLOG on any command line and press F4.
2. Type the parameter value for the kind of error log information that you want to print. For example, you can specify \*ALL to print all the error codes, or specify \*ALLSUM to print a summary of the error log.
3. Press Enter. The error log information is sent to the output queue that is identified in your user profile.

4. Type GO ASSIST on any command line to display the Operational Assistant menu.
5. Look for the error log at or near the bottom of the printer output list on the Work with Printer Output display.
6. Type 5 (Display) to view the printer output.

You can also print the error logs.

#### **Related tasks**

“Print error logs” on page 53

If you have errors, you might want to print the error log.

## **Details: CL commands**

You can use several problem analysis commands when you experience problems with your system.

- Use the Analyze Problem (ANZPRB) command to analyze, create problem records for, or report user-detected problems.
- Use the Verify Communications (VFYCMN) command to verify either remote or local communications equipment.
- Use the Verify Tape (VFYTAP) command to start procedures that verify whether the specified tape unit is operating.
- Use the Work with Alerts (WRKALR) command to remotely analyze system-detected problems.
- Use the Work with Problems (WRKPRB) command to gather more information about a problem to either solve it or to report it without the help of a hardware service provider.

#### **Related information**

CL command finder

## **Use the Analyze Problem (ANZPRB) command**

Use the Analyze Problem (ANZPRB) command to start problem analysis for user-detected problems.

A new problem is one that you detect while using the system and that has not been recorded in the problem log. A new problem is also one that is in the problem log with a status of opened. When the analysis is complete, the results are stored in the problem record. The results are used to search for Program Temporary Fixes (PTFs) to correct the problem or to prepare a new service request if the problem cannot be solved.

To analyze a new problem that has not been recorded in the problem log, perform the following steps:

1. Type ANZPRB on the command line.
2. Select the option that most closely corresponds to the problem listed on the Analyze a New Problem display. A series of steps then guides you through problem analysis. As you progress through problem analysis, the system builds a symptom string that is based on your responses.

**Note:** If you encounter the Problem Analysis display while you are building your symptom string, contact your service provider before continuing.

3. When you complete problem analysis, the collected information is placed in the problem log.

#### **Related concepts**

“CL commands” on page 28

You can use problem analysis control language (CL) commands to help you manage problems you are experiencing with your system.

“Report problems detected by the system” on page 36

The system problem log allows you to display a list of all the problems recorded on the system.

#### **Related reference**

Analyze Problem (ANZPRB)

### Analyze a problem with opened status:

To analyze a problem that has been recorded in the problem log with an opened status, follow these steps:

1. Type DSPMSG QSYSOPR on any command line and press the Enter key to see the system operator messages.
  - If the message is highlighted, use option 5 (Display details and reply) for the message. On the Additional Message Information display, press F14 (Work with problem).
  - If the message has an asterisk (\*) next to it, press F14 (Work with problem) on the Display Messages display.
2. Select option 8 (Work with problem), and then option 1 (Analyze problem). As you progress through problem analysis, the system builds a symptom string based on your responses.
3. When you complete problem analysis, the collected information is placed in the problem log.

### Additional method to analyze a problem with opened status:

You can also use the following method to analyze a problem with open status in the problem log:

1. Type WRKPRB on any command line.
2. Select option 8 (Work with problem) for the problem, and then option 1 (Analyze Problem).

### Examples: Analyze Problem (ANZPRB) command:

#### Example 1: Display the menu

```
ANZPRB
```

This command shows the Analyze Problem menu.

#### Example 2: Start remote analysis

```
ANZPRB ANZTYPE(*REMOTE)
```

This command shows the display that prompts for the remaining values of the command. After you specify the appropriate values, remote analysis begins.

#### Example 3: Access remote system with user ID and password

```
ANZPRB ANZTYPE(*REMOTE) RCPNAME(RCH38377) USERID(JON) PASSWORD
```

This command shows the display that prompts for the remaining values of the command. After you specify the appropriate values beyond the ones that are specified on the command example, remote analysis begins.

#### Example 4: Remote analysis has security level of 10

```
ANZPRB ANZTYPE(*REMOTE) RCPNAME(RCH38377) USERID(JON)
```

This command is slightly different than the preceding example. The same display prompt appears. However, if you do not specify PASSWORD, the system assumes that the remote system has a security level of 10; that is, it does not use passwords. After you specify the appropriate values beyond the ones that are specified on the command example, remote analysis begins.

## Example 5: Display menu

```
ANZPRB ANZTYPE(*MENU)
```

This command shows a menu that prompts you for the type of analysis that you want done. The remaining parameters do not appear on the display.

## Example 6: Start local analysis

```
ANZPRB ANZTYPE(*LOCAL)
```

This command begins analysis on the local device. The remaining parameters do not appear on the display.

## Use the Verify Communications (VFYCMN) command

The Verify Communications (VFYCMN) command allows you to verify either remote or local communications equipment.

The prompt display allows you to select the system on which you want to verify remote communications.

1. Type VFYCMN on any command line.
2. Press F4 (Prompt).

Depending on the system's configuration, you can run tests on the following communications equipment:

- Cable
- Communications input/output adapter
- Communications interface trace
- Link
- Local modem
- Remote modem
- Link Problem Determination Aid-2 (LPDA-2)

### Related concepts

"CL commands" on page 28

You can use problem analysis control language (CL) commands to help you manage problems you are experiencing with your system.

### Related reference

Verify Communications (VFYCMN)

**Examples: Verify Communications (VFYCMN) command:**

## Example 1: Showing select a line to test display

```
VFYCMN
```

This command shows the Select a Line to Test display.

## Example 2: Checking a remote system

```
VFYCMN VFYTYPE(*REMOTE)
```

This command shows the display that prompts for the remaining values of the command. After you specify the appropriate values, remote analysis begins.

### Example 3: Accessing a remote system using a password

```
VFYCMN VFYTYPE(*REMOTE) RCPNAME(RCH38377) USERID(JON) PASSWORD
```

This command shows the display that prompts for the remaining values of the command. After you specify the appropriate values beyond the ones that are specified on the command example, remote analysis begins.

### Example 4: Accessing a remote system without a password

```
VFYCMN VFYTYPE(*REMOTE) RCPNAME(RCH38377) USERID(JON)
```

This command is similar to the preceding example except that the `PASSWORD` parameter is not specified. The same prompt display is shown; however, the system assumes that the remote system has a security level of 10; that is, it does not use passwords. Another prompt display appears after this command is specified. After the user specifies the appropriate values on this display, remote analysis begins.

### Example 5: Checking a local system

```
VFYCMN VFYTYPE(*LOCAL)
```

This command begins analysis on the local device. The remaining parameters do not appear on the display.

### Use the Verify Tape (VFYTAP) command

Use the Verify Tape (VFYTAP) command to start procedures that verify whether the specified tape unit is operating.

#### Related concepts

“CL commands” on page 28

You can use problem analysis control language (CL) commands to help you manage problems you are experiencing with your system.

#### Related reference

Verify Tape (VFYTAP)

### Use the Work with Alerts (WRKALR) command

Use the Work with Alerts (WRKALR) command to remotely analyze system-detected problems that cause the service requester to create and send them to the service provider.

To remotely analyze system-detected problems, perform the following steps:

1. Type `WRKALR` on any command line and press the Enter key.
2. Press F11 (Display user/group) to show the problem IDs associated with the alerts.
3. Type 9 (Work with problem) in the Opt column next to the alert that is associated with the problem you want to analyze. Then press Enter (or press F18 (Work with problem) to work with the problem log).
4. Type 8 (Work with problem) in the Opt column next to the problem you want to analyze.
5. Select option 1 (Analyze problem) from the Work with Problem menu.

#### Related concepts

“CL commands” on page 28

You can use problem analysis control language (CL) commands to help you manage problems you are experiencing with your system.

#### Related reference

Work with Alerts (WRKALR)

### **Example: Work with Alerts (WRKALR) command:**

Type the following command:

WRKALR

1. Press the Enter key.
2. Select the alert you want to work.
3. Use the different options on the Work with Alerts display to complete the required task.

### **Use the Work with Problems (WRKPRB) command**

With problem analysis, you can gather more information about a problem to either solve it or to report it without the help of a hardware service provider.

You can run problem analysis on messages that are highlighted (basic assistance level) or have an asterisk (\*) next to them (intermediate assistance level). If you do not see any of these messages, you might not be authorized to the Work with Problem (WRKPRB) command, or the message does not support additional problem analysis.

To run the Work with Problem (WRKPRB) command for messages that are highlighted, follow these steps:

1. Select option 5 (Display details and reply) for the message
2. Press F14 (Work with problem)

#### **Related concepts**

“CL commands” on page 28

You can use problem analysis control language (CL) commands to help you manage problems you are experiencing with your system.

#### **Related tasks**

“Run the Work with Problems (WRKPRB) command” on page 59

Learn how to run the Work with Problems (WRKPRB) command for messages with an asterisk.

#### **Related reference**

Work with Problems (WRKPRB)

### **Examples: Work with Problems (WRKPRB) command:**

#### **Example 1: Display Entries with Status of OPENED or READY**

```
WRKPRB STATUS(*OPENED *READY) HDW(9347)
```

This command shows the Work with Problems display. It will list only those problem entries with a status of OPENED or READY, which identify a failing device with type 9347.

#### **Example 2: Display Current Day Problem Entries**

```
WRKPRB PERIOD((*AVAIL *CURRENT))
```

This command shows the Work with Problems display. It will list all problem entries that were created on the current day.

#### **Example 3: Display List of Hardware Problems**

```
WRKPRB SEV(1 2) HARDWARE(9347 001 10-7523489)
```



This command shows a list that contains problems with the hardware that is specified by the user. The user has specified that the command track medium to high levels of severity.

## Run the Work with Problems (WRKPRB) command

Learn how to run the Work with Problems (WRKPRB) command for messages with an asterisk.

To run the Work with Problems (WRKPRB) command for messages with an asterisk, perform the following steps:

1. Move your cursor to the message and press F14. The Additional Message Information display appears.
2. Press the F14 (Work with problem) key. From the Work with Problem (WRKPRB) display, you can display the details of the problem and work directly with the problem.

### Related tasks

“Use the Work with Problems (WRKPRB) command” on page 58

With problem analysis, you can gather more information about a problem to either solve it or to report it without the help of a hardware service provider.

## Details: Problem-handling menus

Use the problem-handling menus to help analyze problems.

Your server problems can originate from the following areas:

- Job or programming
- System performance
- Equipment
- Communications
- Remote system

If you are experiencing problems with your system, use the following problem-handling menus to help analyze problems.

- Use the GO NETPRB menu to handle problems that relate to communications.
- Use the GO NETWORK menu to manage and use network communications.
- Use the GO PROBLEM menu to work with problems.
- Use the GO PROBLEM2 menu to work with programming problems and system performance.
- Use the GO TECHHELP menu to work with system operation problems.
- Use the GO USERHELP menu to learn about using help and analyzing problems.

### Use the GO NETPRB menu

From the network problem-handling (NETPRB) menu, you can handle problems that relate to communications.

Verifying that the links are working correctly is a good place to start your problem investigation.

To access this menu:

1. Type GO NETPRB on any command line and press Enter.
2. Select the menu option for the task you want to perform.

### Related concepts

“Problem-handling menus” on page 28

Use the problem-handling menus to help analyze problems.

### Use the GO NETWORK menu

From the network management (NETWORK) menu, you can manage and use network communications.

Many of the options on this menu are for the advanced user, for example, someone who is responsible for a network of systems. Other problem-handling menus contain options that help users find problems on their own workstations or on specific systems within a single network.

To access this menu:

1. Type GO NETWORK on any command line and press Enter.
2. Select the menu option for the task you want to perform.

**Related concepts**

“Problem-handling menus” on page 28

Use the problem-handling menus to help analyze problems.

## Use the GO PROBLEM menu

The problem-handling (PROBLEM) menu is the main menu for working with problems.

From the problem-handling menu, you can analyze problems, create problem records, view problem records, and report problems to the service provider. In addition, you can check message queues and the history log.

To access this menu:

1. Type GO PROBLEM on any command line and press Enter.
2. Select the menu option for the task you want to perform.

**Related concepts**

“Problem-handling menus” on page 28

Use the problem-handling menus to help analyze problems.

**Related tasks**

“Use the GO PROBLEM2 menu”

The second problem-handling (PROBLEM2) menu is an extension of the PROBLEM menu.

## Use the GO PROBLEM2 menu

The second problem-handling (PROBLEM2) menu is an extension of the PROBLEM menu.

From the PROBLEM menu, you can analyze problems at a cursory level. From the PROBLEM2 menu, you can perform tasks that allow you to work with programming problems and system performance. These are areas that require more skill in solving problems.

To access this menu:

1. Type GO PROBLEM2 on any command line and press Enter.
2. Select the menu option for the task you want to perform.

**Related concepts**

“Problem-handling menus” on page 28

Use the problem-handling menus to help analyze problems.

**Related tasks**

“Use the GO PROBLEM menu”

The problem-handling (PROBLEM) menu is the main menu for working with problems.

## Use the GO TECHHELP menu

If you encounter problems that are related to system operation, start with the Technical Support Tasks (TECHHELP) menu.

You can save the necessary information for a technical support person to do problem analysis by using the options from this menu. It is also possible to have a remote support organization access your system from a remote workstation.

To access this menu:

1. Type GO TECHHELP on any command line and press Enter.
2. Select the menu option for the task you want to perform.

**Related concepts**

“Problem-handling menus” on page 28

Use the problem-handling menus to help analyze problems.

## Use the GO USERHELP menu

This menu is for the novice who wants to learn about using help and who needs help in analyzing problems.

From the information and problem-handling (USERHELP) menu, you can record information about the system that helps resolve problems. You can record information about a particular problem by using **option 10** (Save information to help resolve a problem). Note that Option 10 creates a problem record and several spooled files that can be helpful to the analyzer.

To access this menu:

1. Type GO USERHELP on any command line and press Enter.
2. Select the menu option for the task you want to perform.

**Related concepts**

“Problem-handling menus” on page 28

Use the problem-handling menus to help analyze problems.

## Details: Authorized program analysis reports

You can use these parameters for the APAR command.

**valid** The volume ID of the one or more diskettes or tapes where you want to store the system data areas.

**object** The load member that contains the program that caused the program check to occur. The system places the load member in diskette or tape file that is named APARLOAD.

**source** The source member from which the program was created. The system places the source member in diskette or tape file that is named APARSRCE.

**proc** The procedure member from which the program was called. The system places the procedure member in a diskette or a tape file that is named APARPROC.

**dumpfile**

The file that is created by a task dump. Specify zero (0) if you want to copy the most recent dump file. If you do not specify a file name when you run the APAR procedure from a display station, the status of all dump files is displayed. You can select to copy one or none of the files. If you do not specify a file name and the APAR procedure is not being run from a display station, no dump file is copied to diskette or tape.

Dump files are named #DUMP.nn on disk, where nn is a number from 00 through 99.

**S1** Indicates that you want to use slot one of the diskette drive (the 5360 system had multiple slots and the 9402 model 236 has only one). On the 9402 Model 236, S1 is the only slot that can be used. If you do not specify a parameter, S1 is assumed.

**AUTO**

Specifies that you want to automatically save the results of the APAR procedure to the next slot on a multiple slot diskette drive. You cannot use this parameter on the 9402 Model 236.

**NOAUTO**

Specifies that you do not want to automatically save the results of the APAR procedure to the next slot on a multiple slot diskette drive. You cannot use this parameter on the 9402 Model 236.

- I1** Specifies that the information collected by the APAR procedure is to be copied to diskette.
- TC** Specifies that the information collected by the APAR procedure is to be copied to the 1/4 inch tape cartridge mounted in the tape drive. If no parameter is specified, TC is assumed.
- T1** Specifies that the information collected by the APAR procedure is to be copied to the 1/2 inch tape reel mounted in tape drive 1.
- T2** Specifies that the information collected by the APAR procedure is to be copied to the 1/2 inch tape reel that is mounted in tape drive 2.

**Related concepts**

“Use authorized program analysis reports” on page 29

An authorized program analysis report (APAR) is an IBM-supplied program that allows you to create a diskette file or a tape file that contains information from your system to help software service representatives to correct programming problems.

## Determine the primary or alternative consoles

If the Operations Console has been configured as the primary console, the system will start the Operations Console.

If the Operations Console has not been configured, the primary console is a workstation that is attached to the first IOP that is capable of supporting workstations.

In addition to the primary console, the system can assign up to two alternative consoles. The first alternative console can only be a TWINAX workstation that is attached to the same IOP as the primary console. The second alternative console is a workstation that is attached to the next IOP or Input/Output Adaptor (IOA) that is capable of supporting workstations.

The IOP that supports the console must be on the first system bus (bus 1).

If a workstation is not correctly attached to the first IOP that is capable of attaching workstations, then the system will not assign a primary console. The system will display a reference code on the operator’s panel. In addition, if the IPL mode is set to Manual, the system will stop.

The following information is covered here:

- Primary console workstation requirements
- Find the primary console when the system is operational
- Find the primary console when the system power is off

### Primary console workstation requirements

In order to be the primary console, the workstation must be operational and have the correct port and address. If the workstation is a PC, it must also have an active emulation program on the workstation.

The workstation requirements are:

- TWINAX workstation - Port 0 Address 0
- ASCII workstation - Port 0
- PC attached to ASCII IOP or IOA
  - Port 0
  - PC software to emulate a 316x or 3151 terminal
- PC attached to TWINAX IOP
  - Port 0 Address 0
  - 5250 emulator software active on PC

- PC attached to a LocalTalk IOA (6054)
  - SNAPs 5250 Version 1.2 (or above) application
  - Console capable selected on MacIntosh (IOA converts to Port 0 Address 0)
- PC attached to a 2609, 2612, 2699, or 2721 communications IOA
  - Client Access Console cable attached to the 2609 or 2612 P2 port (part number 46G0450 or 46G0479), 2699 (part number 21H3779), or 2721 (part number 44H7504)
  - Operations Console cable attached to the 2609 or 2612 (part number 97H7555), 2699 (part number 97H7556), or 2721 (part number 97H7557) - 5250 emulation or Rumba active on PC

## Find the primary console when the system is operational

There are three methods that can be used to find the primary console:

- **Method 1:** Look for a sign-on display with a DSP01 in the upper-right corner.
- **Method 2:** If the device name (DSP01) for the console has been changed, you can verify the device name for the primary console by following these steps:
  1. Enter DSPCTLD QCTL on any command line. The Display Controller Description display appears.
  2. Find the Resource name parameter (such as CTL01) and record it.
  3. Enter PRTDEVADR rrrr on any command line, where rrrr is the resource name you recorded.

**Note:** The data will print if the printer is active.

- **Method 3:**
  1. Enter STRSST on any command line. The System Service Tools display appears.
  2. Select **option 1** (Start a service tool).
  3. Select **option 7** (Hardware service manager).
  4. Select **option 2** (Logical hardware resources).
  5. Select **option 1** (System bus resources). On the Logical Hardware Resources on System Bus display, the "<" symbol indicates the IOP that the console is attached to.
  6. Use **option 9** (Resource associate with IOP and display detail) to find the location of the system bus, board, and card.

## Find the primary console when the system power is off

Use one of the following methods:

- Turn on the system in **Manual** mode and look for the IPL and Install System display.
- Turn on the system in **Normal** mode and look for DSP01 on the sign on display.

**Note:** The name might have been changed. See Find the primary console when the system is operational to determine the display name.

## Replace the battery power unit on Models 5xx and expansion units FC 507x and FC 508x

Use this procedure to remove or replace the battery power unit on Models 5xx, and expansion units FC 507x, and FC 508x.

The part number for the battery power unit is 86G8040.

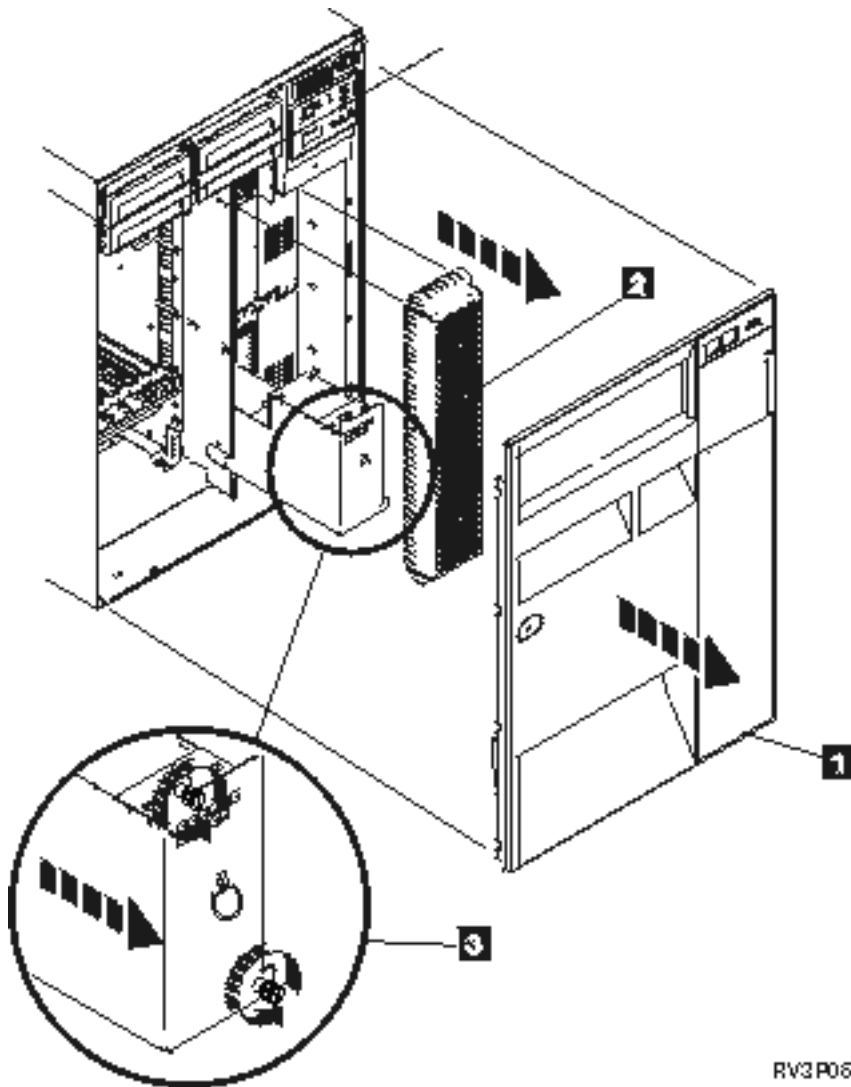

RV3P060-1

Figure 1. Removal of the battery power unit on Models 5xx, and expansion units FC 507x and FC 508x.

1. Do not turn off the system.
2. Remove the front cover (see 1 in Figure 2).
3. Pull out and lift to remove the screen (see 2 in Figure 2).

**Attention:** Removing the battery power unit while the system is running on battery power will cause the system to fail and might damage the battery power unit and the card enclosure.

4. Ensure that the system is not running on battery power. As a test, be sure that the console accepts system commands before removing the battery power unit.

**CAUTION:**

**Be careful when removing or installing this part or unit. This part or unit is heavy, but has a weight smaller than 18 kilograms (39.7 pounds). (RSFTC201)**

5. Loosen the screws and use two hands to pull the battery power unit out (see 3 in Figure 2).
6. Install the battery power unit by reversing the removal procedure.

**CAUTION:**

The battery is a lead-acid battery. To avoid possible explosion, do not burn. Exchange only with the IBM-approved part. Recycle or discard the battery as instructed by local regulations.





In the United States, IBM has a process for the collection of this battery. For information, call 1-800-426-4333. Have the IBM part number for the battery unit available when you call.

---

## Related information for troubleshooting

Listed here are the iSeries manuals and IBM Redbooks™ (in PDF format), and information center topics that relate to the Troubleshooting topic. You can view or print any of the PDFs.

### Manuals

- Backup and Recovery book (about 4000 KB)  .
- For more information about defining and working with messages, see the CL Programming book (about 5000 KB)  .
- Local Device Configuration book (about 750 KB)  .
- IBM Redbooks AS/400e Diagnostic Tools for System Administrators book (about 4300 KB)  .

### iSeries Information Center

- CL command finder
- Common SRCs for software installation
- IPL SRC finder
- Logical partition SRC finder
- See Manage service tools user IDs for information about changing service tools user IDs and passwords, located in the **Security → Service tools user IDs and passwords**.
- Scenario: Message monitor in the Management Central topic

### Saving PDF files

To save a PDF on your workstation for viewing or printing:

1. Right-click the PDF in your browser (right-click the link above).
2. Click the option that saves the PDF locally.
3. Navigate to the directory where you want to save the PDF.
4. Click **Save**.

### Downloading Adobe Reader

- | You need Adobe Reader installed on your system to view or print these PDFs. You can download a free
- | copy from the Adobe Web site ([www.adobe.com/products/acrobat/readstep.html](http://www.adobe.com/products/acrobat/readstep.html))  .

---

## Code license and disclaimer information

IBM grants you a nonexclusive copyright license to use all programming code examples from which you can generate similar function tailored to your own specific needs.

- | SUBJECT TO ANY STATUTORY WARRANTIES WHICH CANNOT BE EXCLUDED, IBM, ITS
- | PROGRAM DEVELOPERS AND SUPPLIERS MAKE NO WARRANTIES OR CONDITIONS EITHER
- | EXPRESS OR IMPLIED, INCLUDING BUT NOT LIMITED TO, THE IMPLIED WARRANTIES OR

| CONDITIONS OF MERCHANTABILITY, FITNESS FOR A PARTICULAR PURPOSE, AND  
| NON-INFRINGEMENT, REGARDING THE PROGRAM OR TECHNICAL SUPPORT, IF ANY.

| UNDER NO CIRCUMSTANCES IS IBM, ITS PROGRAM DEVELOPERS OR SUPPLIERS LIABLE FOR  
| ANY OF THE FOLLOWING, EVEN IF INFORMED OF THEIR POSSIBILITY:

- | 1. LOSS OF, OR DAMAGE TO, DATA;
- | 2. DIRECT, SPECIAL, INCIDENTAL, OR INDIRECT DAMAGES, OR FOR ANY ECONOMIC  
| CONSEQUENTIAL DAMAGES; OR
- | 3. LOST PROFITS, BUSINESS, REVENUE, GOODWILL, OR ANTICIPATED SAVINGS.

| SOME JURISDICTIONS DO NOT ALLOW THE EXCLUSION OR LIMITATION OF DIRECT,  
| INCIDENTAL, OR CONSEQUENTIAL DAMAGES, SO SOME OR ALL OF THE ABOVE LIMITATIONS  
| OR EXCLUSIONS MAY NOT APPLY TO YOU.



---

## Appendix. Notices

This information was developed for products and services offered in the U.S.A.

IBM may not offer the products, services, or features discussed in this document in other countries. Consult your local IBM representative for information on the products and services currently available in your area. Any reference to an IBM product, program, or service is not intended to state or imply that only that IBM product, program, or service may be used. Any functionally equivalent product, program, or service that does not infringe any IBM intellectual property right may be used instead. However, it is the user's responsibility to evaluate and verify the operation of any non-IBM product, program, or service.

IBM may have patents or pending patent applications covering subject matter described in this document. The furnishing of this document does not grant you any license to these patents. You can send license inquiries, in writing, to:

IBM Director of Licensing  
IBM Corporation  
North Castle Drive  
Armonk, NY 10504-1785  
U.S.A.

For license inquiries regarding double-byte (DBCS) information, contact the IBM Intellectual Property Department in your country or send inquiries, in writing, to:

IBM World Trade Asia Corporation  
Licensing  
2-31 Roppongi 3-chome, Minato-ku  
Tokyo 106-0032, Japan

**The following paragraph does not apply to the United Kingdom or any other country where such provisions are inconsistent with local law:** INTERNATIONAL BUSINESS MACHINES CORPORATION PROVIDES THIS PUBLICATION "AS IS" WITHOUT WARRANTY OF ANY KIND, EITHER EXPRESS OR IMPLIED, INCLUDING, BUT NOT LIMITED TO, THE IMPLIED WARRANTIES OF NON-INFRINGEMENT, MERCHANTABILITY OR FITNESS FOR A PARTICULAR PURPOSE. Some states do not allow disclaimer of express or implied warranties in certain transactions, therefore, this statement may not apply to you.

This information could include technical inaccuracies or typographical errors. Changes are periodically made to the information herein; these changes will be incorporated in new editions of the publication. IBM may make improvements and/or changes in the product(s) and/or the program(s) described in this publication at any time without notice.

Any references in this information to non-IBM Web sites are provided for convenience only and do not in any manner serve as an endorsement of those Web sites. The materials at those Web sites are not part of the materials for this IBM product and use of those Web sites is at your own risk.

IBM may use or distribute any of the information you supply in any way it believes appropriate without incurring any obligation to you.

Licensees of this program who wish to have information about it for the purpose of enabling: (i) the exchange of information between independently created programs and other programs (including this one) and (ii) the mutual use of the information which has been exchanged, should contact:

IBM Corporation

Software Interoperability Coordinator, Department YBWA  
3605 Highway 52 N  
Rochester, MN 55901  
U.S.A.

Such information may be available, subject to appropriate terms and conditions, including in some cases, payment of a fee.

- | The licensed program described in this information and all licensed material available for it are provided
- | by IBM under terms of the IBM Customer Agreement, IBM International Program License Agreement,
- | IBM License Agreement for Machine Code, or any equivalent agreement between us.

Any performance data contained herein was determined in a controlled environment. Therefore, the results obtained in other operating environments may vary significantly. Some measurements may have been made on development-level systems and there is no guarantee that these measurements will be the same on generally available systems. Furthermore, some measurements may have been estimated through extrapolation. Actual results may vary. Users of this document should verify the applicable data for their specific environment.

Information concerning non-IBM products was obtained from the suppliers of those products, their published announcements or other publicly available sources. IBM has not tested those products and cannot confirm the accuracy of performance, compatibility or any other claims related to non-IBM products. Questions on the capabilities of non-IBM products should be addressed to the suppliers of those products.

All statements regarding IBM's future direction or intent are subject to change or withdrawal without notice, and represent goals and objectives only.

This information contains examples of data and reports used in daily business operations. To illustrate them as completely as possible, the examples include the names of individuals, companies, brands, and products. All of these names are fictitious and any similarity to the names and addresses used by an actual business enterprise is entirely coincidental.

#### COPYRIGHT LICENSE:

This information contains sample application programs in source language, which illustrate programming techniques on various operating platforms. You may copy, modify, and distribute these sample programs in any form without payment to IBM, for the purposes of developing, using, marketing or distributing application programs conforming to the application programming interface for the operating platform for which the sample programs are written. These examples have not been thoroughly tested under all conditions. IBM, therefore, cannot guarantee or imply reliability, serviceability, or function of these programs.

Each copy or any portion of these sample programs or any derivative work, must include a copyright notice as follows:

© (your company name) (year). Portions of this code are derived from IBM Corp. Sample Programs. © Copyright IBM Corp. \_enter the year or years\_. All rights reserved.

If you are viewing this information softcopy, the photographs and color illustrations may not appear.

---

## Programming Interface Information

This Troubleshooting information documents intended Programming Interfaces that allow the customer to write programs to obtain the services of IBM i5/OS.

---

## Trademarks

The following terms are trademarks of International Business Machines Corporation in the United States, other countries, or both:

- | AS/400e
- | e(logo)server
- | eServer
- | i5/OS
- | IBM
- | IBM (logo)
- | iSeries
- | Redbooks
- | xSeries

Other company, product, and service names may be trademarks or service marks of others.

---

## Terms and conditions

Permissions for the use of these publications is granted subject to the following terms and conditions.

**Personal Use:** You may reproduce these publications for your personal, noncommercial use provided that all proprietary notices are preserved. You may not distribute, display or make derivative works of these publications, or any portion thereof, without the express consent of IBM.

**Commercial Use:** You may reproduce, distribute and display these publications solely within your enterprise provided that all proprietary notices are preserved. You may not make derivative works of these publications, or reproduce, distribute or display these publications or any portion thereof outside your enterprise, without the express consent of IBM.

Except as expressly granted in this permission, no other permissions, licenses or rights are granted, either express or implied, to the publications or any information, data, software or other intellectual property contained therein.

IBM reserves the right to withdraw the permissions granted herein whenever, in its discretion, the use of the publications is detrimental to its interest or, as determined by IBM, the above instructions are not being properly followed.

You may not download, export or re-export this information except in full compliance with all applicable laws and regulations, including all United States export laws and regulations.

IBM MAKES NO GUARANTEE ABOUT THE CONTENT OF THESE PUBLICATIONS. THE PUBLICATIONS ARE PROVIDED "AS-IS" AND WITHOUT WARRANTY OF ANY KIND, EITHER EXPRESSED OR IMPLIED, INCLUDING BUT NOT LIMITED TO IMPLIED WARRANTIES OF MERCHANTABILITY, NON-INFRINGEMENT, AND FITNESS FOR A PARTICULAR PURPOSE.







Printed in USA