



IBM Systems - iSeries

Networking

Token ring

Version 5 Release 4





IBM Systems - iSeries
Networking
Token ring

Version 5 Release 4

Note

Before using this information and the product it supports, read the information in “Notices,” on page 35.

Sixth Edition (February 2006)

This edition applies to version 5, release 4, modification 0 of IBM i5/OS (product number 5722-SS1) and to all subsequent releases and modifications until otherwise indicated in new editions. This version does not run on all reduced instruction set computer (RISC) models nor does it run on CISC models.

© Copyright International Business Machines Corporation 1999, 2006. All rights reserved.

US Government Users Restricted Rights – Use, duplication or disclosure restricted by GSA ADP Schedule Contract with IBM Corp.

Contents

Token ring.	1	Enable objects to accept connections	22
Printable PDF	1	View the address of your LAN IOA	23
Understand token-ring support	1	Configuration object commands	23
Supported token-ring functions	1	Tune token-ring performance	24
Connection establishment between LAN devices	2	Adjust your LAN-frame size.	24
SNA connections to LAN protocols	4	Timing	26
Maximum frame size of token ring	5	Troubleshoot token ring	30
Plan for token-ring support	5	Troubleshoot LANs.	30
Maximum LAN frame size	6	Why some LAN connections fail	31
LAN IOA addresses	6	Why PCs do not connect to your system	31
Configure token-ring support.	6	Understand the token-ring address format	32
Configure TCP/IP over token ring	7	Code license and disclaimer information.	34
Configure SNA over token ring	7	Appendix. Notices	35
Examples: Configure SNA over token ring	10	Programming Interface Information	36
Manage token-ring support	20	Trademarks	37
Change the line descriptions to use token ring.	20	Terms and conditions	37
Assign the token-ring line description to a TCP/IP interface	21		

Token ring

Use this information to provide token-ring support for TCP/IP and Systems Network Architecture (SNA).

Existing installations:

Users who have existing token-ring line descriptions can change them to take advantage of the 100 megabit per second (Mbps) card. If you use the line description with TCP/IP, you must also assign it to a TCP/IP interface.

Token-ring support information:

You can use this information to configure and manage token-ring support on your server.

Note: By using the code examples, you agree to the terms of the “Code license and disclaimer information” on page 34.

Printable PDF

Use this to view and print a PDF of this information.

To view or download the PDF version of this document, select Token ring (about 523 KB).

Saving PDF files

To save a PDF on your workstation for viewing or printing:

1. Right-click the PDF in your browser (right-click the link above).
2. Click the option that saves the PDF locally.
3. Navigate to the directory in which you want to save the PDF.
4. Click **Save**.

Downloading Adobe Reader

- You need Adobe Reader installed on your system to view or print these PDFs. You can download a free copy from the Adobe Web site (www.adobe.com/products/acrobat/readstep.html) .

Understand token-ring support

After you understand token-ring support, you can plan how to configure the system.

Supported token-ring functions

Your server supports a range of token-ring technologies that support speeds of 4 Mbps, 16 Mbps, and 100 Mbps.

These technologies support the IEEE 802.5 standard. The 100 Mbps token-ring input/output adapter (IOA) supports the High-Speed Token-Ring IEEE 802.5 standard that specifies 100 Mbps operation.

The 100 Mbps token ring IOA:

Your system can use the PCI 100/16/4 MB Token-Ring Adapter to support faster networking. The IOA supports many protocols including TCP/IP and Systems Network Architecture (SNA). It is compatible with earlier devices, but does not support token-pipes or multilink. The adapter is also known as the 2744 IOA. The IOA introduces these new functions:

- **Automatic ring-speed sensing** (automatic sense) enables your system and the switch to find the highest common ring speed to use between them. The destination does not need to match this speed, because the switch manages the differences in speed.
- **Duplex mode negotiation** enables your system and the switch to agree on the duplex mode to use (half or full duplex). The available duplexing modes are dependent on the ring speed that you use. At 4 Mbps or 16 Mbps you can use either half-duplex or full-duplex mode. At 100 Mbps you must use full-duplex mode (the speed for each channel (transmitting or receiving) is 100 Mbps).

Early token release:

Only 16 Mbps rings that use half-duplex mode can use the early token release function. This function reduces the time the next device on the same ring waits for a free token. Early token release enables the transmitting device to release the free token right after sending a frame. Thus, the next device receives the free token sooner and can thereby transmit a frame. This function is beneficial only in rings where the time to transmit a frame is shorter than the travel time of the frame. That is, the time for the frame to travel completely around the ring.

Connection establishment between LAN devices

If you use Systems Network Architecture (SNA) with a LAN protocol, use this information to establish the connection between LAN devices.

The correct relationship between a line description and a controller description helps to ensure connection establishment. A controller description determines which line descriptions your system uses. Therefore, you must ensure that the controller description refers to the correct line description.

Also, a line description governs the number of active controllers that can access it. By making the number too small, you might prevent the controller description from accessing the line description. Therefore, you should ensure a large enough value to allow the controller description access to the line description.

Besides the correct relationship between the line and controller descriptions, the descriptions must also contain the correct information to ensure connection establishment. The following information discusses some of the connection information that you are responsible for.

How LAN devices identify themselves

Your system compares the exchanged information against the information contained in the line and controller descriptions.

During the connection process, your system sends information to the remote device, which the device uses to ensure connection to the correct system. The remote device also sends information to your system, which your system uses to ensure the connection to the correct device. If the exchanged information matches the information contained in the line and controller descriptions and other connection values are correct, the connection process continues. Likewise, the remote device performs a similar process.

Your system and the remote device use two verifications during the connection process to ensure connection to the correct device. One verification (required), matches the line description information and controller description information with the connection information that the remote device sent. If a match occurs, your system continues with the connection process.

This list shows the information that the remote device sends:

- The address associated with the input/output adapter (IOA) on the remote device. This address is either the preset address or the locally administered address.

- The source service access point (SSAP) on the remote device.
- The destination service access point (DSAP).

The other verification matches the exchange identifier values. For Advanced Program-to-Program Communications (APPCs), this verification is optional. Systems Network Architecture (SNA) hosts that use parallel connections require this verification.

SNA exchange identifiers:

To establish a connection, your system and the remote device exchange information that includes the exchange identifiers (XIDs).

Systems Network Architecture (SNA) hosts that use parallel connections require the XIDs. You define the XIDs in the controller description. Typically, during the connection process your system conducts an initial poll with NULL XIDs to determine whether the remote device is active or not. If the remote device does not respond to the poll within the specified time period, your system can send another XID to the device. If the remote device responds to the poll, your system and the remote device exchange XIDs and establish the link.

The controller description for SNA hosts names the XID value as the local exchange identifier. The Advanced Program-to-Program Communication (APPC) controller description names the XID value as the exchange identifier.

Which LAN device initiates the connection

In a Systems Network Architecture (SNA) environment you can determine who initiates the connection request and who waits for an incoming connection request.

To have your system initiate the connection, configure the controller description to dial the destination. If no connection is established, your controller description switches to answer mode (where it waits for a device to dial into your system).

To have your system wait for incoming calls, configure the controller description to answer the incoming calls. You use dial mode to make connection requests and answer mode to have the system wait for incoming connection requests. You specify one of these modes through the Initial connection (INLCNN) field of the controller description.

Dial mode (SNA):

You use dial mode (that is used by Systems Network Architecture (SNA) controller descriptions) to send a connection request to a remote device.

Dial mode starts when you vary on the controller description. During the dialing process, the system polls the remote device to determine if the device is ready to transmit. If the remote device is ready, the connection process continues. Successful connection is still possible even if the local and remote devices dial each other simultaneously.

These controller description fields control the frequency and duration of the polling:

- LAN connection retry (LANCNRITY) determines the number of times your system polls the remote device.
- LAN connection timer (LANCNNTMR) determines the length of time between each poll.

If the remote device answers the poll within the time that these parameters specify, your system proceeds with establishing the connection. If not, your system sends an inquiry message (CPA58E0 or CPA57EF) to the system operator message queue. This message indicates that a connection attempt failed and that the controller description is now in answer mode.

Answer mode (SNA):

If you specify answer mode, the input/output adapter (IOA) cannot send connection requests, but can respond to incoming connection-requests.

Systems with controller descriptions that are configured with dial mode send the connection requests. The controller description must be varied on before the system can respond to a connection request.

SNA connections to LAN protocols

You or the system can connect Systems Network Architecture (SNA) to a LAN protocol by using one or more service access points (SAPs).

Multiple SAPs allow you to have multiple connections between SNA and a LAN protocol, thus permitting multiple communication paths between independent applications.

You or the system specifies the SAPs to use in the line and controller descriptions. For SNA, the system can automatically create one SAP value (the default value). There might be cases where you want to change this value or have additional SAPs:

- The remote system does not use the default source service access point (SSAP).
- You want parallel station-to-station connections between adapters. This might be what you want if you link two applications that require different controller descriptions.
- You want station-to-station connections to the same adapters. You might want to do this to configure multiple SAPs to test an application on a single system.

If you plan to change the SAP defaults, see your SAPs for guidelines and other information.

SSAP and DSAP:

Local SAPs are known as source service access points (SSAPs). The remote SAPs are known as destination service access points (DSAPs). Your system sends data from a SSAP to a DSAP.

Your SNA service access points

If you decide to change the default Systems Network Architecture (SNA) service access points (SAPs) or add more SAPs, you must define them in the line and controller descriptions.

On the system, you define the source SAPs, or in other words the source service access points (SSAPs). You can specify up to 24 SSAPs per line description when you define the SAPs. The SSAPs that your controller description uses must come from the line description that is associated with the controller description.

Your controller description specifies the destination service access points (DSAPs) to which your line description can connect.

You should remember this point when specifying your SSAPs and DSAPs: your DSAP is the SSAP of the remote device, and the DSAP of the remote device is your SSAP. For example, this table shows how to define the SSAPs and DSAPs when your SSAP is 04 and the remote SSAP is 08:

Table 1. Local and remote SSAPs and DSAPs

Local device	Remote device
SSAP = 04	SSAP = 08
DSAP = 08	DSAP = 04

For SNA, you must use certain SSAP values. You can find the help for selecting these values by pressing F1 (Help) while your cursor is on the SSAP list field of the line description.

Maximum frame size of token ring

This topic contains a few guidelines and tips for specifying the maximum frame size.

First, here is some background information to help you understand the reasons for the guidelines and tips.

Larger frames require less processing overhead than the same data that is divided up among many smaller frames. Therefore, the use of larger frame sizes can improve the performance of your system. However, the frame size that you select can be reduced if other entities within the communications path cannot support the frame size.

Maximum frame size fields:

You can use these fields to specify the maximum frame size (the parentheses show location of the field):

- Maximum frame size (line description) affects all devices that use the line description.
- Source service access point (SSAP) maximum frame size (line description) affects only devices that use the SSAP and line description.
- Maximum frame size (controller description) affects all line descriptions that are associated with the controller description.

If you specify a maximum frame size in two or more of these fields, the system selects the smallest size. To ease the frame size configuration of your line and controller descriptions, use these guidelines:

- Use the largest possible frame size that the network connection supports.
- Specify the maximum frame size only in the Maximum frame size field of the line description. The system then uses this value for all other maximum frame size fields.
- Specify a size smaller than the maximum frame size of the input/output adapter (IOA) if you receive a frame rejection error.

Reduction of selected maximum frame size:

Other entities within the communications path can reduce your maximum frame size if they cannot support it. Some of these entities are:

- Remote IOAs or other devices: Some support only smaller maximum frame sizes.
- Line or controller description: These descriptions on the remote system sometimes specify a smaller maximum frame size.
- Devices: Some do not support maximum frame size negotiations.

Solution:

If negotiation does not produce a common frame size, a frame reject (FRMR) condition occurs, and your system sends message CPA58E2 to message queue QSYSOPR. If you cannot change the frame size of the other entities, use an acceptable maximum frame size value in your line or controller description.

Plan for token-ring support

To make the configuration of token-ring support easier, you need to make some decisions about how to configure your connections.

Maximum LAN frame size

Typically, you set the maximum frame size to the largest size supported by your input/output adapter (IOA). But, if the device cannot support your frame size, change to a size that the device can support.

The larger your frame size, the more data your system can pack into it. Hence, your data throughput can increase. However, a device will drop the frame if it cannot support your frame size. If you cannot configure the device to support your frame size, change your maximum frame size to a size that the device can support.

You can change one or more of these maximum frame size fields (the parentheses contain the location of the field):

- Source service access point (SSAP) maximum frame size (line description)
- Maximum frame size (line descriptions for token ring and gigabit Ethernet networks)
- Maximum frame size (controller description)

The maximum frame size used by your system during the connection process will be the smallest of these fields.

LAN IOA addresses

In a Systems Network Architecture (SNA) environment, you can determine the address for each input/output adapter (IOA).

You can use one of two addresses:

- The manufacturer-assigned address that is otherwise known as the burned-in address, preset address, or universally-administered address.
- The locally administered address.

You define the locally administered address, and the system associates it with the adapter. Using a locally administered address minimizes the reconfiguration work when you replace the adapter.

For example, if you use the burned-in address of the adapter, you must configure this address into every device that communicates with the adapter. When you replace the adapter, you must go back to each device and reconfigure them with the burned-in address of the new adapter. You cannot assign the burned-in address of the replaced adapter to the new adapter.

You can avoid the reconfiguration work by associating a locally administered address with the adapter and using this address in all devices that communicate with the adapter. When you replace the adapter, associate the locally administered address with the new adapter. Because the devices already have the locally administered address, you do not need to re-configure them.

Note: No two adapters can have the same address in the same network.

Configure token-ring support

To configure token-ring support for TCP/IP or Systems Network Architecture (SNA), use this information.

After understanding and planning your token-ring support, you are ready to configure token ring on the system.

Configure TCP/IP over token ring

You can use iSeries™ Navigator to configure token-ring support for TCP/IP.

Follow these steps:

1. If you have not done so already, install iSeries Navigator.
2. iSeries Navigator can use an existing line description. To use an existing line description, change it. Then return here to continue these steps.
3. In iSeries Navigator, expand the server that will provide token-ring support for TCP/IP.
4. Use the LAN Configuration Wizard to configure a new TCP/IP interface to use token ring with TCP/IP. As you create a new token-ring line for the 100 Mbps card while creating the interface, remember these items about the duplex modes:
 - At 4 Mbps or 16 Mbps you can use half-duplex or full-duplex modes.
 - At 100 Mbps you can only use full duplex.
5. If you did not start the TCP/IP interface, you can do so now by enabling it to accept connections.

Configure SNA over token ring

To Configure Systems Network Architecture (SNA) over token ring, you need to create the token-ring line description, the controller description, and sometimes the device description.

To configure SNA over token ring, do these steps:

1. Create the token-ring line description. Ensure the correct configuration of these fields when you create the line description:
 - If the system uses this line description to communicate with an SNA host through a parallel connection, define a value other than *LIND in the Exchange identifiers field.
 - Advanced Peer-to-Peer Networking (APPN) and Advanced Program-to-Program Communication (APPC) connections use fields **Link speed** through **Autodelete controller**. You can use the defaults or press F1 (Help) for more information about each field.
 - If you want the system to create the APPC controller description when a call comes in, specify *YES in the Autocreate controller field. If you specified *YES, skip to step 3.
2. Create the controller description.
3. If your controller description does one of these, you must create a device description:
 - Specifies *NONE in the Autocreate device field.
 - Specifies *NO in the APPN-capable field (this applies only to APPC controller descriptions)
4. Enable the descriptions to accept connections.

If you need help with configuring the token-ring support for your SNA environment, see Examples: Configuring SNA over token ring.

Create the token-ring line description

To create a token-ring line description, use the Create Line Description command and follow a series of steps.

The information assumes that you are not using token-ring card with Netfinity® or the integrated xSeries® server.

- **TCP/IP:** To use TCP/IP over token ring, see Configure TCP/IP over token ring.
- **Systems Network Architecture (SNA):** To configure a token-ring line description through the server console, use the Create Line Description (Token Ring) (CRTLINTRN) command and follow the steps in this page.

Note: This page explains some of the fields that require additional information. You can also find other help information by pressing F1 (Help) when your cursor is on the field in question.

1. Select an input/output adapter (IOA) to use with your line description. If you are not familiar with the capabilities of the IOA, see Token-ring IOAs.

You are now at the Create Line Description (Token Ring) (CRTLINTRN) display. Notice that the system copied the name of the IOA to the Resource name field.

Do not press Enter while at this display unless instructed to do so; otherwise, you might exit the display. To move from field to field, move your cursor or press the Tab key.

2. Type a name for your line description into the Line description field.
3. Press Enter twice, and then F10 (Additional fields).
4. Indicate the appropriate number of active controller descriptions that can use the line description in the Maximum controller field. See Connection establishment between LAN devices for more information about accessing a line description through a controller description.
5. In the Line speed field, indicate the speed of the IOA.

Note: You enable automatic ring-speed sensing (automatic sense) when specifying *AUTO or 100M. Automatic sense starts initially at 100 megabit per seconds (Mbps). To use automatic sense successfully, you must enable it only on your system or on the switch to which your system connects. That is, do not enable both devices; otherwise, the correct speed might not be selected.

6. Select the duplex mode to use with your IOA.

Note: Duplex mode negotiation occurs when you specify *AUTO or *FULL. Duplex mode negotiation initially starts at full-duplex mode. The switch must support duplex negotiation before you can successfully use this function. If you are not familiar with the capabilities of the IOA, see Token-ring IOAs.

7. Specify the largest possible frame size in the Maximum frame size field.
8. Assign an address to the IOA by using the Local adapter address field.
To determine whether to use the burned-in address of the adapter or a locally administered address, read LAN IOA addresses. To use the burned-in address, accept the default value of *ADPT.
To specify a locally administered address, find a valid address and enter it into the field. To find a valid address, move your cursor to the field and press F1 (Help) for more information.
9. List all the source service access points (SSAP) that your controller should use in the Source service access point field. Accept the default value of *SYSGEN or specify your SSAPs. If you define the SSAP values, move the cursor to the field and press F1 (Help) to help determine what values to use.
For more information about whether you or the system should define the service access points (SAPs), see SNA connections to LAN protocols.
10. Leave the SSAP maximum frame field blank unless you need to enter a value.
11. If you use this line description with half duplex mode and with a 16 Mbps ring, you can take advantage of early token release. To do this, specify *YES in the Early token release field.
12. Press Enter to create the line description.
13. If an error occurs, the system might present to you some options to correct the error. Select the option that you want. You can also move your cursor to the error message and press F1 (Help) to see the cause of the error and the possible fixes.
14. Press F3 (Exit).

Token-ring IOAs:

Some duplex modes and maximum frame sizes are supported by the input/output adapters (IOAs).

Table 2. Duplex modes and maximum frame sizes supported by the token-ring IOAs.

IOA	Duplex modes supported		Maximum frame sizes		
	100 Mbps	16/4 Mbps	100 Mbps	16 Mbps	4 Mbps
2619, 2626	N/A	Half	N/A	16393	4060
6149, 2724	N/A	Full or half	N/A	16393	4060
2744	Full	Full or half	16393	16393	4060
N/A - Not applicable					

Select a LAN IOA:

Before creating your line description, you must select the input/output adapter (IOA) to use with it.

Use the Work with Hardware Resources (WRKHDWRSC) command to identify the name of your IOA and to select the IOA.

To identify and select the IOA, follow these steps (even if you know the name of the IOA):

1. Type WRKHDWRSC *CMN and press Enter.
A list appears that shows the attached iSeries communications resources, and their type numbers, operational statuses, and descriptive text.
2. Locate an IOA by looking in the descriptive text column for a phrase that describes a port for your LAN type. For example, if you use Ethernet, look for Ethernet port. If you use token-ring, look for Token-ring port.
3. When you find an IOA, move your cursor to its Opt field.
4. Type 5 (Work with configuration descriptions) and press Enter.
5. Type 1 (Create) and press Enter.

Create the SNA controller description

The controller description indicates the remote devices to which the system connects.

To create a controller description to use with your LAN adapter, follow these steps:

1. See Create an APPC controller description to find out which create controller command to use. Then return here to configure the description.
2. Type the name of the command to use and press F4 (Prompt).
3. Type the name of the controller description into the Controller description field.
4. Specify *LAN in the Link type field.
5. Press Enter three times.
6. The system displays more fields that might require this information (for more help, press F1 (Help) while your cursor is on the field):
 - *Switched line list* specifies one or more line descriptions that should use your controller description. For more information about the relationship between the line and controller descriptions, see connection establishment.
 - *Remote control point* names the local control point of the remote IBM® **@server** iSeries system. Use the Display Network Attributes (DSPNETA) command on the remote system to view its local control point name.
 - *Exchange identifier* contains the exchange identifier for your system. Advanced Program-to-Program Communication (APPC) requires the ID. This ID has two parts. To determine the value for the first part, press F1 (Help) when your cursor is on this field. You can get the value for the second part from the line description on the remote system that is used to connect to your system. To understand the purpose of exchange identifiers, read How LAN devices identify themselves.



- *Local exchange identifier* identifies your iSeries to the host system. This field exists only in the host controller description. Parallel connections between your system and a Systems Network Architecture (SNA) host require an exchange identifier.
 - *Initial connection* determines whether the controller description initiates connection requests (*DIAL), or waits for incoming connection requests (*ANS).
If you specify *DIAL and want to adjust the polling duration or frequency, change the LAN connection retry (LANCNNRTY) or LAN connection timer (LANCNNTMR) field.
 - *LAN remote adapter address* contains the address of the remote input/output adapter (IOA). To find this address, see View the address of your adapter. If you are using the preset address of the adapter, read LAN IOA addresses to minimize your reconfiguration work.
 - *LAN destination service access point* (DSAP) contains the source service access point (SSAP) value from the controller description that is on the remote device. For more information about service access points (SAPs), see SNA connections to LAN protocols.
 - *LAN source service access point*(SSAP) contains a value from the SSAP list of the line description that is associated with this controller description.
7. For detailed information about all the parameters and their dependencies, see the Communications Configuration manual on the V5R1 Supplemental Manuals Web site  .
 8. Press Enter three times to create the description.

Create the SNA device description

The device description describes the communications device used by the remote device.

There are no LAN-specific parameters in the device description.

To create the Systems Network Architecture (SNA) device description, follow these steps:

1. To create the device description, find the create command to use in Create APPC device descriptions (this information also has other commands for Advanced Peer-to-Peer Networking (APPN) devices, Single Network Point (SNPT) devices, and so forth). Then return here to configure the description.
2. Type the name of the command to use and press F4 (Prompt).
3. Type the name of device description into the Device description field.
4. Complete these fields as described:
 - *Remote location* is the name from the Local location field of the device description that is on the remote device. If the Local location field contains *NETATR, use the Display Network Attributes (DSPNETA) command at the remote device. Use this command to view the name that is specified by the Default local location field.
 - *Remote network identifier* is the network identifier of the remote IBM  iSeries system. To find this value, use the Display Network Attributes (DSPNETA) command at the remote system to locate the Local network ID field. Advanced Program-Program Communication (APPC) device descriptions use the Remote network identifier field.
5. For detailed information about all the parameters and their dependencies, see the Communications Configuration manual on the V5R1 Supplemental Manuals Web site  .
6. Press Enter twice to create the description.

Examples: Configure SNA over token ring

These examples describe the dependencies of a parameter or the required parameter values for various SNA network environments.

This command creates the TOKENRING1 line description that all the examples use.

```
CRTLINTRN LIND(TOKENRING1) RSRNAME(TRN_IOA) LINESPEED(16M)
          MAXFRAME(16393) ADPTADR(400003190001) EXCHID(05600000)
          SSAP((04 *MAXFRAME *CALC) (08))
```

This figure shows the network used by the examples.

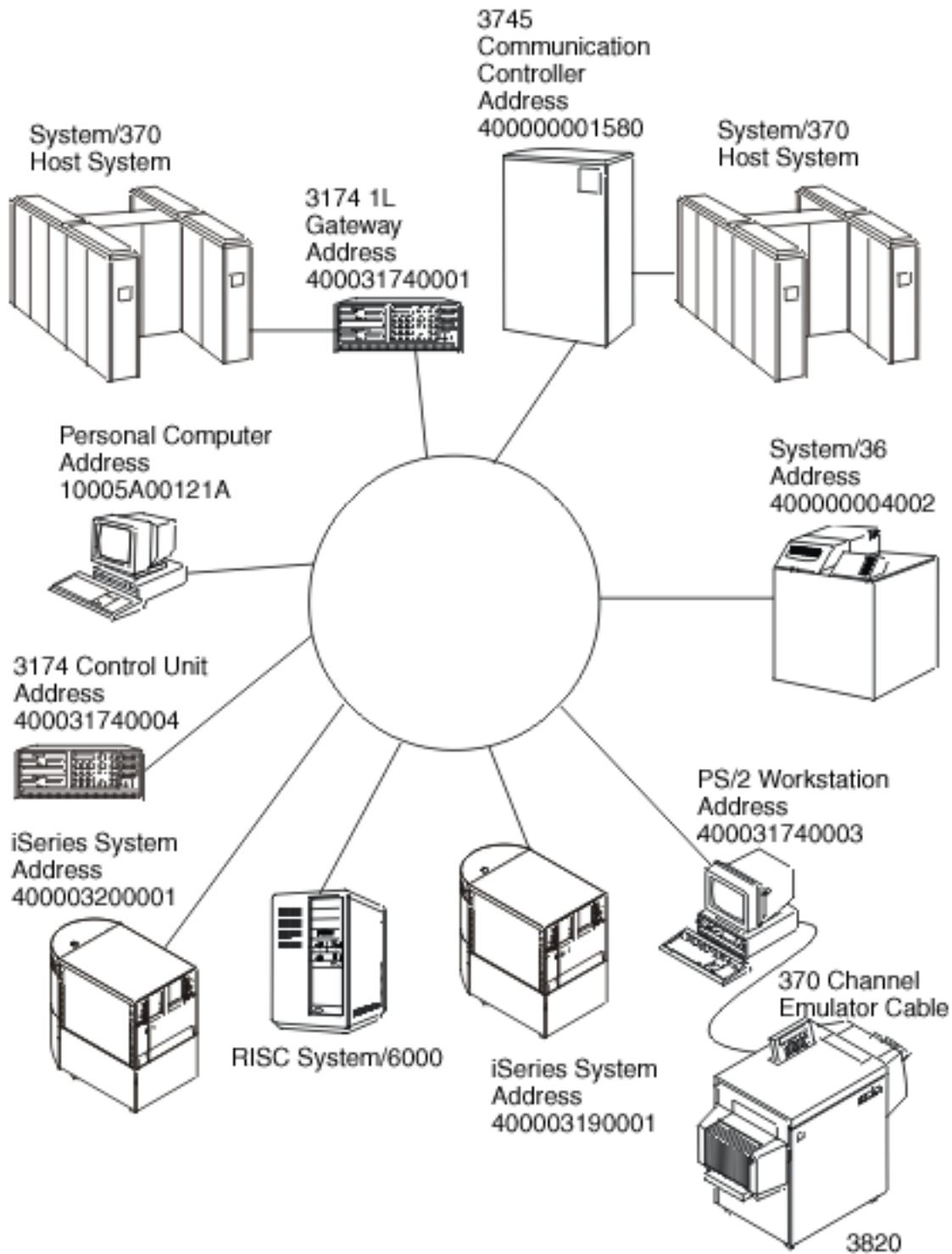

Figure 1. Example token-ring network

Related concepts

APPN configuration examples

Example: Connect a server to another server

This example shows how to create Advanced Program-to-Program Communication (APPC) over token-ring connection from your server to another server.

The name of the local server is LOCAL, and the name of the remote system is REMOTE.

Note: Because all the examples use the same token-ring line description, this example discusses only the controller and device descriptions.

Focus on these points in this example:

- The service access points (SAPs) in the controller descriptions. For more information about SAPs, read SNA connections to LAN protocols.
- The adapter address used by a controller description must match the address that is used in the line description on the remote device. This table shows the adapter addresses that are used by the line and controller descriptions on both systems.

Table 3. Local and remote adapter addresses

	LOCAL	REMOTE
Adapter address in line description	400003190001	400003200001
Adapter address referred to by the controller description	400003200001	400003190001

- The way a system identifies the other system to which it connects. Both sides must use the same method. These are the methods:
 - Only use the Remote exchange identifier parameter.
 - Use the Remote network identifier and the Remote control point name parameters.

In this example, each system uses the Remote network identifier and Remote control point name (RMTCPNAME) parameters to indicate the system to which it connects.

Note that within a system the remote network identifier must be the same in the controller and device description. Because the example uses the default value of *NETATR for the Remote network identifier parameter, this parameter is not shown.

Get the value for the Remote control point name parameter from the other system. To do this, use the Display Network Attributes (DSPNETA) command on the other system and locate the Local control point name field.

TOKENRING2:

This example uses this line description on the remote system.

```
CRTLINTRN LIND(TOKENRING2) RSRNAME(TRN_IOA) LINESPEED(16M)
MAXFRAME(16393) ADPTADR(400003200001) EXCHID(05600000)
SSAP((04 *MAXFRAME *CALC) (08 *MAXFRAME *CALC))
TEXT('Line description for 400003200001')
```

Controller descriptions:

These examples show the controller descriptions that are used on the local and remote systems.

```
CRTCTLAPPC CTLD(LOCAL_CD) LINKTYPE(*LAN) SWTLINLST(TOKENRING1)
RMTCPNAME(REMOTECP) ADPTADR(400003200001) DSAP(04)
SSAP(08) TEXT('Controller description on LOCAL')
```

```
CRTCTLAPPC CTLD(REMOTE_CD) LINKTYPE(*LAN) SWTLINLST(TOKENRING2)
RMTCPNAME(LOCALCP) ADPTADR(400003190001) DSAP(08)
SSAP(04) TEXT('Controller description on REMOTE')
```

Device descriptions:

In the device descriptions, the Remote network identifier (RMTNETID) parameter should match the local network-identifier of the remote system. You must use the Display Network Attributes (DSPNETA) command on the remote system to view the local network-identifier.

```
CRTDEVAPPC DEVD(LOCAL_DD) RMTLOCNAME(REMOTE) LCLLOCNAME(LOCAL)
           CTL(LOCAL_CD) MODE(BLANK)
           TEXT('APPC device description describing system REMOTE')

CRTDEVAPPC DEVD(REMOTE_DD) RMTLOCNAME(LOCAL) LCLLOCNAME(REMOTE)
           CTL(REMOTE_CD) MODE(BLANK)
           TEXT('APPC device description describing system LOCAL')
```

Example: Connect the server to itself

This example connects your system to itself. That is, the tokens travel around the local token ring network before returning to your system.

You can do the example to test an application within your system before testing it in the network. Because all the examples use the same token-ring line description, this example discusses only the controller and device descriptions.

Two sets of controller and device descriptions connect your system to itself. The first set dials (initiates) a connection request, and the second set answers (accepts) the connection request.

In this example, focus on these points:

- Use a different source service access point (SSAP) for each controller.
- Use the same adapter address in both controller descriptions.
- Use dial mode in one controller description and answer mode in the other.

Dial command set:

```
CRTCTLAPPC CTLD(DIAL_CD) LINKTYPE(*LAN) APPN(*NO) INLCNN(*DIAL)
           SWTLINLST(TOKENRING1) ADPTADR(400003190001)
           DSAP(08) SSAP(04)
           TEXT('Link from SAP 04 to 08')

CRTDEVAPPC DEVD(DIAL_DD) RMTLOCNAME(ANS) LCLLOCNAME(DIAL)
           CTL(DIAL_CD) MODE(BLANK) APPN(*NO)
```

Answer command set:

```
CRTCTLAPPC CTLD(ANS_CD) LINKTYPE(*LAN) APPN(*NO) INLCNN(*ANS)
           SWTLINLST(TOKENRING1) ADPTADR(400003190001)
           DSAP(04) SSAP(08)
           TEXT('Link from SAP 08 to 04')

CRTDEVAPPC DEVD(ANS_DD) RMTLOCNAME(DIAL) LCLLOCNAME(ANS)
           CTL(ANS_CD) MODE(BLANK) APPN(*NO)
```

Example: Connect a server to a System/36

This example uses Advanced Program-to-Program Communication (APPC) to connect your server to a System/36™ system.

Because all the examples use the same token-ring line description, this example discusses only the controller and device descriptions. On the remote system, the System/36 administrator must configure an APPC-subsystem member and a token-ring-line member to connect to your system.

The controller and device descriptions must disable Advanced Peer-to-Peer Network (APPN) and not use remote IDs by using the APPN and RMTNETID parameters like this:

```

CRTCTLAPPC CTLD(CTL_36) LINKTYPE(*LAN) APPN(*NO)
          SWTLINLST(TOKENRING1) RMTNETID(*NONE) EXCHID(03E00000)
          ADPTADR(400000004002)
          TEXT('APPC controller description describing System/36')

CRTDEVAPPC DEVD(DEV_36) RMTLOCNAME(SYSTEM36) RMTNETID(*NONE)
          MODE(BLANK) APPN(*NO)

```

Example: Connect a server to a 3745 host

This example connects your system to a 3745 host. You can also find more information about configuring the host at the end of this example.

Focus on these points for this example:

- The controller description destination service access point (DSAP) must specify 04 to connect to the host. The example does not show this parameter because 04 is the default.
- The host can refer to only service access points (SAPs) 04 through 94; therefore, your service source access point (SSAP) must be within this range. The example does not show this parameter because it uses the default value of 04.

Controller description:

```

CRTCTHOST CTLD(TRLANHOST) LINKTYPE(*LAN) SWTLINLST(TOKENRING1)
          RMTCPNAME(LANAPPN) LCLEXCHID(*LIND)
          ADPTADR(4000000001580) NODETYPE(*LENODE)
          TEXT('Controller description describing the 3745 host')

```

Device descriptions:

```

CRTDEVHOST DEVD(TRLANEML) LOCADR(01) RMTLOCNAME(HOST)
          CTL(TRLANHOST) APPTYPE(*EML)
          TEXT('3270 emulation over TOKENRING1')

CRTDEVHOST DEVD(TRLANPRT) LOCADR(0C) RMTLOCNAME(HOST)
          CTL(TRLANHOST) APPTYPE(*EML) EMLDEV(3287)
          TEXT('3270 printer emulation over TOKENRING1')

CRTDEVDSP DEVD(TRLANDHCF) DEVCLS(*RMT) TYPE(3277) MODEL(*DHCF)
          LOCADR(02) CTL(TRLANHOST) TEXT('DHCF over TOKENRING1')

```

Host configuration:

On the host, you must generate a physical and a logical configuration before the system can connect to it.

Example: Create a host physical-configuration:

The network control program generation (NCP GEN) produces the physical configuration that is necessary to connect the 3745 Communication Controller to your server.

The system administrator creates the NCP GEN for the GROUP and LINE macroinstructions.

You must ensure that the location address (LOCADD) parameter matches the Remote adapter address (ADPTADR) field of the controller description. This example shows the LOCADD parameter in bold:

```

R1G006P GROUP ECLTYPE=PHYSICAL
R1080P LINE ADDRESS=(080,FULL),LOCADD=(400000001580),PORTADD=01,
          ISTATUS=INACTIVE
R1080PA PU ADDR=01,ISTATUS=INACTIVE
R1080PA1 LU LOCADDR=0,
          LUDR=NO
R1G006L GROUP ECLTYPE=LOGICAL,
          PHYPORT=80
R108000 LINE
R108000A PU MAXLU=32

```

```

R108001 LINE
R108001A PU   MAXLU=32
R108002 LINE
R108002A PU   MAXLU=32
R108003 LINE
R108003A PU   MAXLU=32
R108004 LINE
R108004A PU   MAXLU=32
R108005 LINE
R108005A PU   MAXLU=32
R108006 LINE
R108006A PU   MAXLU=32
R108007 LINE
R108007A PU   MAXLU=32

```

Note: This example is valid only on Network Control Program (NCP) Version 4.2 and Virtual Telecommunications Access Method (VTAM[®]) Version 3.1.1. Different NCP or VTAM levels might require different parameters.

Example: Create a host logical-configuration:

The network control program generation (NCP GEN) produces the logical configuration to connect the 3745 Communication Controller to your server.

This example configuration is valid only on Network Control Program (NCP) Version 4.2 and Virtual Telecommunications Access Method (VTAM) Version 3.1.1. Different NCP or VTAM levels might require different parameters.

In this example, focus on these points:

- Identifier block (IDBLK) and identifier number (IDNUM)
- Dial number (DIALNO)

The concatenation of the IDBLK and IDNUM values must match the Local exchange identifier (LCLEXCHID) value of your controller description. In this example, because the controller description specifies *LIND in field LCLEXCHID, the value comes from the Exchange identifier (EXCHID) field of the line description.

The DIALNO parameter specifies the source service access point (SSAP) and the adapter address of your server. This is the format of DIALNO:

```
aabb4000cccccccc
```

This is the explanation of the format:

- **aa** is the value of the PORTADD parameter that is specified in the physical configuration.
- **bb** is the SSAP value from your controller description.
- **4000cccccccc** is the address of your adapter that is specified in the line description. In this example, the address is 400003190001 (see the ADPTADR parameter of line description TOKENRING1).

This logical configuration example shows the IDBLK, IDNUM, and DIALNO parameters in bold:

```

SW3270C  VBUILD TYPE=SWNET,      REQUIRED PARAMETER          X
          MAXNO=8,              *
          MAXGRP=5
S3270C   PU   ADDR=C1,          8 BIT STATION UNIQUE ADDRESS  X
          DISCNT=NO,           ACCEPT DISCONTACT FROM PU (DEFAULT) X
          IDBLK=056,           12 BIT BLOCK NUMBER FOR STATION X
          IDNUM=00000,         20 BIT ID NUMBER FOR AS/400 SYSTEM X
          MAXDATA=1994,
          MAXPATH=8,           MAXIMUM OF 8 STATIONS MAY BE CALLED X
          NETID=AS400,         LOCAL NETWORK ID ON AS/400      X

```

```

MAXOUT=7,          7 PIUS TO STATION BEFORE RESPONSE      X
PACING=7,          NCP SENDS 7 TO LU AND MARKS FIRST      X
PASSLIM=7,        MAXIMUM OF 7 CONTIGUOUS PIUS          X
PUTYPE=2,         TYPE OF STATION CALLING IN             X
ISTATUS=ACTIVE,   ACTIVATE WITH MAJOR NODE              X
MODETAB=LOGMOD38, I/S DEFINED TABLE                    *
SSCPFM=USSSCS,   VTAM TO STRIP/ADD MEDIA CONTROL CHAR *
VPACING=7        VTAM SENDS 7 TO NCP AND MARKS FIRST
S348L80 PATH GRPNM=R1G006L,DIALNO=0104400003190001,PID=1 319-R1080
SW327C01 LU   LOCADDR=1,          AS/400 LOCADDR VALUE X'01'          X
                ISTATUS=ACTIVE   ACTIVATE WITH MAJOR NODE
SW327C02 LU   LOCADDR=2,          AS/400 LOCADDR VALUE X'02'          X
                ISTATUS=ACTIVE   ACTIVATE WITH MAJOR NODE
SW327C12 LU   LOCADDR=12,        AS/400 LOCADDR VALUE X'0C'          X
                ISTATUS=ACTIVE   ACTIVATE WITH MAJOR NODE

```

Example: Connect a server to a 3174 Model 1L gateway

In this example a 3174 Control Unit functions as a gateway to connect two systems that support different network architectures. You can also find an example to connect the gateway to your system at the end of this example.

Because all the examples use the same token-ring line description, this example discusses only the controller and device descriptions. This example does not show the source service access point (SSAP) and destination service access point (DSAP) parameters because they use the default values.

Controller description:

```

CRTCTHHOST CTLD(TRLANHOST2) LINKTYPE(*LAN) SWTLINLST(TOKENRING1)
                RMTCPNAME(*ANY) ADPTADR(400031740001)
                TEXT('Controller description describing the 3174 Gateway')

```

Device description:

Although this device description example is not specific to token-ring networks, you can use it to configure an emulation display:

```

CRTDEVHOST DEVD(TRLANEML2) LOCADR(01) RMTLOCNAME(HOST2)
                CTL(TRLANHOST2) APPTYPE(*EML)
                TEXT('3270 emulation for Host2')

```

Example: Create the NCP GEN for a 3174 gateway:

The system administrator creates the network control program generation (NCP GEN) to connect your server to the 3174.

You must ensure that the address specified by the control-unit address (CUADDR) parameter is correct. The last 2 characters of this parameter must match the Control Unit Address value. This value is specified in the Ring Address Assignment display and the Ring Transmission Definition display of the 3174.

Note: This example is valid on Network Control Program (NCP) Version 4.2 and Virtual Telecommunications Access Method (VTAM) Version 3.1.1. Different NCP or VTAM levels might require different parameters.

This is the NCP GEN (the CUADDR parameter is in bold):

```

R13B1   VBUILD TYPE=LOCAL
R13B0A  PU   CUADDR=3B1,
                DISCNT=(NO,F),
                ISTATUS=ACTIVE,
                PUTYPE=2,
                SPAN=(SYSPGMR),
                SSCPFM=USSSCS,

```

```

X
X
X
X
X
X

```

```

R13B102  LU  VPACING=7
           DLOGMOD=P6ES2,
           ENCR=NONE,
           ISTATUS=ACTIVE,
           LOCADDR=2,
           LOGAPPL=SAMON,
           MODETAB=LOGMOD38,
           SPAN=(SYSPGMR),
           SSCPFM=USSSCS,
           VPACING=7
           X
           X
           X
           X
           X
           X
           X
           X

```

Example: Connect a server to a 3174 subsystem control unit

This example connects your system to a 3174 (Model 3R or 53R) subsystem control unit.

Because all the examples use the same token-ring line description, this example discusses only the controller and device descriptions. You can find suggestions for configuring the 3174 at the end of this example.

Controller description:

```

CRTCTLRWS CTLD(TR_3174) TYPE(3174) MODEL(0) LINKTYPE(*LAN)
           SWTLINLST(TOKENRING1) ADPTADR(400031740004)
           TEXT('Controller description describing the 3174')

```

Device description:

This device description does not have any 3174 specific fields, so use whatever device descriptions you need:

```

CRTDEVDSP DEVD(3279_DSP) DEVCLS(*RMT) TYPE(3279) MODEL(0)
           CTL(TR_3174)
           TEXT('Device description describing the 3279 display')

```

3174 configuration suggestions:

Ensure that the token-ring display on the 3174 contains the correct adapter addresses. The address fields must match the local adapter address field of the line description and the remote adapter address field of the controller description. Also, ensure that the maximum frame sizes match those that are specified by the Maximum frame size field of the line description.

Example: Create parallel connections to a host

This example connects your system to a host system through a 3745 Communications Controller by using parallel connections.

Each connection has a separate instance of the logical link control and a separate bandwidth. Thus, communications can still occur even if one link becomes nonfunctional.

Because all the examples use the same token-ring line description, this example discusses only the controller and device descriptions. You can find the configuration for the 3745 controller in Example: Configure the physical and logical parallel connections on the host system.

Controller descriptions:

In this example, focus on these points:

- The controller descriptions use the same line description.
- The controller descriptions use different local exchange IDs. You must use exchange IDs to establish parallel connections.
- The controller descriptions use different source service access points (SSAPs).

- The 3745 Communications Controller requires that you specify 04 for the destination service access point (DSAP).

```
CRTCTLHOST CTLD(CTL_1A) LINKTYPE(*LAN) APPN(*NO)
      SWTLINLST(TOKENRING1) LCLEXCHID(056A001A)
      ADPTADR(400000001592) DSAP(04) SSAP(04)
      TEXT('Controller for the first link')
```

```
CRTCTLHOST CTLD(CTL_2A) LINKTYPE(*LAN) APPN(*NO)
      SWTLINLST(TOKENRING1) LCLEXCHID(056A002A)
      ADPTADR(400000001592) DSAP(04) SSAP(08)
      TEXT('Controller for second link')
```

Device descriptions for CTL_1A:

These commands create the device descriptions that are used with the CTL_1A controller description:

```
CRTDEV DSP DEVD(DSPA001A02) DEVCLS(*RMT) TYPE(3279) MODEL(0)
      LOCADR(02) CTL(CTL_1A) APPTYPE(*NRF)
      TEXT('NRF device, LOCADDR 02')
```

```
CRTDEV DSP DEVD(DSPA001A03) DEVCLS(*RMT) TYPE(3279) MODEL(0)
      LOCADR(03) CTL(CTL_1A) APPTYPE(*NRF)
      TEXT('NRF device, LOCADDR 03')
```

```
CRTDEV HOST DEVD(EMLA001A04) LOCADR(04) RMTLOCNAME(SWXIDA04)
      CTL(CTL_1A) APPTYPE(*EML)
      TEXT('Emulation display, LOCADDR 04')
```

```
CRTDEV PRT DEVD(PRTA001A05) DEVCLS(*RMT) TYPE(3287) MODEL(0)
      LOCADR(05) CTL(SWTRNCTL1A) APPTYPE(*NRF)
      LOGON('LOGON APPLID(NRF2A07) LOGMODE(SCSTRYR)')
      TEXT('NRF printer, LOCADDR 05')
```

Device descriptions for CTL_2A:

These commands create the device descriptions that are used with the CTL_2A controller description:

```
CRTDEV DSP DEVD(DSPA002A02) DEVCLS(*RMT) TYPE(3279) MODEL(0)
      LOCADR(02) CTL(CTL_2A) APPTYPE(*NRF)
      TEXT('NRF device, LOCADDR 02')
```

```
CRTDEV HOST DEVD(EMLA002A04) LOCADR(04) RMTLOCNAME(SWXIDB04)
      CTL(CTL_2A) APPTYPE(*EML)
      TEXT('Emulation display, LOCADDR 04')
```

```
CRTDEV PRT DEVD(PRTA002A05) DEVCLS(*RMT) TYPE(3287) MODEL(0)
      LOCADR(05) CTL(CTL_2A) APPTYPE(*NRF)
      LOGON('LOGON APPLID(NRF2A07) LOGMODE(SCSTRYR)')
      TEXT('NRF printer, LOCADDR 05')
```

Example: Configure the physical and logical parallel connections on the host system:

This example shows the network control program generation (NCP GEN) that is created by a system administrator to connect the 3745 Communication Controller to the server.

This example is valid on Network Control Program (NCP) Version 5.4 and Virtual Telecommunications Access Method (VTAM) Version 3.3. Different NCP or VTAM levels might require different parameters.

This example shows one configuration for each connection and discusses two parameters: Identifier block (IDBLK) and identifier number (IDNUM). The concatenation of IDBLK and IDNUM must match the Local exchange identifier (LCLEXCHID) field of your controller description. The first configuration uses exchange ID 056A001A from controller description CTL_1A. The second uses 056A002A from CTL_2A.

Configuration for the first connection:

In this example, see the IDBLK and IDNUM parameters in bold:

```

*
SWXID  VBUILD TYPE=SWNET,      THIS IS A SWITCHED MAJOR NODE      X
      MAXNO=64,              MAXIMUM DIALNO PARAMETERS          X
      MAXGRP=64              MAXIMUM NUMBER OF LINE GROUPS
SWXIDA  PU  ADDR=01,          NOT CHECKED IF TOKEN-RING DEFINITION X
      DISCNT=NO,            ACCEPT DISCONTACT FROM AS/400      X
      IDBLK=056,           12 BIT BLOCK NUMBER FOR AS/400      X
      IDNUM=A001A,        20 BIT ID FOR THIS PU (AS/400 CTLD) X
      MAXDATA=1994,         MAXIMUM FOR 4M TOKEN RING          X
      MAXPATH=1,            ONLY NEED ONE PATH STATEMENT       X
      MAXOUT=7,             7 PIUS TO DEVICE BEFORE RESPONSE  X
      NETID=APPN,           NETID OF AS/400 (IF DIFFERENT)    X
      PACING=0,             PACING CAN BE ANY ACCEPTABLE VALUE X
      PASSLIM=7,           MAXIMUM OF 7 CONTIGUOUS PIUS      X
      PUTYPE=2,            TYPE OF DEVICE CALLING IN         X
      ISTATUS=ACTIVE,       ACTIVATE WITH MAJOR NODE          X
      MODETAB=LOGMOD38,    ANY VALID LOGMODE TABLE         *
      SSCPFM=USSSCS,       VTAM TO STRIP/ADD MEDIA CONTROL CHAR *
      VPACING=0            VPACING CAN BE ANY ACCEPTABLE VALUE

*
* NOTE: YOU MUST DEFINE ENOUGH LOGICAL TOKEN-RING LINES TO ALLOW
*       ALL PUs TO BE USED AT THE SAME TIME
*
PATHA  PATH  GRPNM=R3G092L,DIALNO=0508400071032004 3
*
* SAME NUMBER OF LUs ON HOST AS DEVICES ON AS/400
*
SWXIDA01 LU  LOCADDR=1,      FIRST AVAILABLE LOCAL ADDRESS      X
      ISTATUS=ACTIVE        ACTIVATE WITH MAJOR NODE
SWXIDA02 LU  LOCADDR=2,      FIRST AVAILABLE LOCAL ADDRESS      X
      ISTATUS=ACTIVE        ACTIVATE WITH MAJOR NODE
SWXIDA03 LU  LOCADDR=3,      FIRST AVAILABLE LOCAL ADDRESS      X
      ISTATUS=ACTIVE        ACTIVATE WITH MAJOR NODE
SWXIDA04 LU  LOCADDR=4,      FIRST AVAILABLE LOCAL ADDRESS      X
      ISTATUS=ACTIVE        ACTIVATE WITH MAJOR NODE
SWXIDA05 LU  LOCADDR=5,      FIRST AVAILABLE LOCAL ADDRESS      X
      ISTATUS=ACTIVE        ACTIVATE WITH MAJOR NODE
SWXIDA06 LU  LOCADDR=6,      FIRST AVAILABLE LOCAL ADDRESS      X
      ISTATUS=ACTIVE        ACTIVATE WITH MAJOR NODE

```

Configuration for the second connection:

In this example, see the IDBLK and IDNUM parameters in bold:

```

*****
SWXIDB  PU  ADDR=02,          NOT CHECKED IF TOKEN-RING DEFINITION X
      DISCNT=NO,            ACCEPT DISCONTACT FROM AS/400      X
      IDBLK=056,           12 BIT BLOCK NUMBER FOR AS/400      X
      IDNUM=A002A,        20 BIT ID FOR THIS PU (AS/400 CTLD) X
      MAXDATA=1994,         MAXIMUM FOR 4M TOKEN RING          X
      MAXPATH=1,            ONLY NEED ONE PATH STATEMENT       X
      MAXOUT=7,             7 PIUS TO DEVICE BEFORE RESPONSE  X
      NETID=APPN,           NETID OF AS/400 (IF DIFFERENT)    X
      PACING=0,             PACING CAN BE ANY ACCEPTABLE VALUE X
      PASSLIM=7,           MAXIMUM OF 7 CONTIGUOUS PIUS      X
      PUTYPE=2,            TYPE OF DEVICE CALLING IN         X
      ISTATUS=ACTIVE,       ACTIVATE WITH MAJOR NODE          X
      MODETAB=LOGMOD38,    ANY VALID LOGMODE TABLE         *
      SSCPFM=USSSCS,       VTAM TO STRIP/ADD MEDIA CONTROL CHAR *
      VPACING=0            VPACING CAN BE ANY ACCEPTABLE VALUE

*
* NOTE: YOU MUST DEFINE ENOUGH LOGICAL TOKEN-RING LINES TO ALLOW
*       ALL PUS TO BE USED AT THE SAME TIME

```

```

* LABEL ON PATH MACRO MUST BE UNIQUE, IF SPECIFIED
*
* PATHB PATH GRPNM=R3G092L,DIALNO=0504400071032004 3
*
* SAME NUMBER OF LUs ON HOST AS DEVICES ON AS/400
*
SWXIDB01 LU LOCADDR=1, FIRST AVAILABLE LOCAL ADDRESS X
            ISTATUS=ACTIVE ACTIVATE WITH MAJOR NODE
SWXIDB02 LU LOCADDR=2, FIRST AVAILABLE LOCAL ADDRESS X
            ISTATUS=ACTIVE ACTIVATE WITH MAJOR NODE
SWXIDB03 LU LOCADDR=3, FIRST AVAILABLE LOCAL ADDRESS X
            ISTATUS=ACTIVE ACTIVATE WITH MAJOR NODE
SWXIDB04 LU LOCADDR=4, FIRST AVAILABLE LOCAL ADDRESS X
            ISTATUS=ACTIVE ACTIVATE WITH MAJOR NODE
SWXIDB05 LU LOCADDR=5, FIRST AVAILABLE LOCAL ADDRESS X
            ISTATUS=ACTIVE ACTIVATE WITH MAJOR NODE
SWXIDB06 LU LOCADDR=6, FIRST AVAILABLE LOCAL ADDRESS X
            ISTATUS=ACTIVE ACTIVATE WITH MAJOR NODE

```

Manage token-ring support

After setting up token-ring support, use this information to help manage this support.

Change the line descriptions to use token ring

To use an existing token-ring line description with iSeries Navigator, you must first change the values for these fields:

- Resource name
- Address field
- Duplex
- Line speed
- Source service access point (SSAP) list (for TCP/IP only)
- Link speed (optional: used for Advanced Peer-to-Peer Networking (APPN) only)

To change the fields, follow these steps:

1. Vary off the line description.
2. Change the field values.

Vary off the line description:

To vary off the line description, use the Work with Line Descriptions (WRKLIND) command like this:

1. Type WRKLIND and press Enter.
2. Locate your line description and place your cursor in its Opt field.
3. Type 8 (Work with status) and press Enter.
4. Type 2 (Vary off) and press Enter.
5. If your line description does not vary off, place your cursor on the error message and press F1 (Help) to view more information about the error. See Get started with system troubleshooting for more troubleshooting help.
6. If an error did not occur, press F3 (Exit) to exit the command, and continue with the next step (Change the field values).

Change the field values:

Now you must change the values in the fields by using the Change Line Description (Token Ring) (CRTLINTRN) command.

To do this, follow these steps:

1. Record the name of the token-ring card by doing these steps:
 - a. Type WRKHDWRSC *CMN and press Enter.
 - b. Search the Type column to locate the correct token-ring card.
 - c. Record the name of the card that is found under the Resource column.
 - d. Press F3 (Exit).
2. Type WRKLIND and press Enter.
3. Locate the line description to change.
4. Type 2 (Change) and press Enter.
5. Type the name of the selected token-ring card into the Resource name field.
6. In the Line speed field, indicate the speed of the input/output adapter (IOA).

Note: You can enable automatic ring-speed sensing (automatic sense) when specifying *AUTO or 100M. Automatic sense starts initially at 100 Mbps. To use automatic sense successfully, you must ensure that your system or the switch that the system connects to is enabled for ring-speed sensing. That is, you should enable ring-speed sensing only on one device; otherwise, an incorrect speed might be selected.

7. Select the duplex mode to use with your IOA.

Note: Duplex mode negotiation occurs when you specify *AUTO or *FULL. The negotiation starts initially at full-duplex mode. The switch must support this type of negotiation before you can successfully use this function. If you are not familiar with the capabilities of the IOA, see token-ring IOAs.

8. If you are using this line description with TCP/IP, ensure that source service access point (SSAP) X'AA' and its associated information are in the SSAP list field.
9. If needed, specify a maximum frame size. If you are not familiar with the capabilities of the IOA, see token-ring IOAs.
10. Press Enter to save your changes, and then press F3 (Exit).
11. Continue with the next task. If you are using this line description with Systems Network Architecture (SNA), enable the description to accept connections. If you are using this line description with TCP/IP, assign it to an interface.

Assign the token-ring line description to a TCP/IP interface

You can assign the token-ring line description to a new or an existing TCP/IP interface through iSeries Navigator.

After changing the existing line description that will be used with the 100 Mbps adapter, you assign the line description to a TCP/IP interface. You do not need to do this if you are using the line description with Systems Network Architecture (SNA).

Assign the line description to a TCP/IP interface:

To assign the line description to a new interface, you must follow the procedure in Configure TCP/IP over token ring to create the interface. During this creation process, you must choose your description from a list of line descriptions.

Note: If other entities know the burned-in address of your old adapter, you must replace that address with the address of the 100 Mbps adapter. This is required if you want them to communicate with the adapter. You can use a locally administered address to avoid these kinds of changes in the future (see LAN IOA address for more information).

To associate your line description with an existing interface, do these steps:

1. If you have not done so already, install iSeries Navigator.
2. If this is the first time you are using iSeries Navigator to access your server, use the wizard to configure TCP/IP on the system.
3. In the navigation bar, expand the server that contains the changed line description.
4. Select **Network** → **Protocol**.
5. Right-click **TCP/IP** and select **Interface**.
6. Double-click the interface that you will assign the line description to.
7. Click the **Resource** tab and select your line description from the **Line name** option.
8. Click **OK**, and then click **OK** again.

Enable objects to accept connections

After configuring LAN support, you are ready to enable your configuration objects to accept connections.

For Systems Network Architecture (SNA), you enable or vary on the line and controller descriptions. For TCP/IP, you can enable or start the interface.

Vary on configuration objects:

To accept connections, you must vary on the configuration objects by using the Work with Configuration Status (WRKCFGSTS) command as follows:

1. Type WRKCFGSTS *LIN and press Enter.
2. Locate your line description.
3. Move your cursor to the Opt field of the line description, type 1 (Vary on), and press Enter.
4. If the line description does not vary on successfully, press F3 (Exit). Then you should read Display message queues to understand how to view the error messages and to find possible solutions.
5. Press F3 (Exit).

If the line description varied on successfully, you should do the same for the controller description if you created one. Vary on the description by using the same instructions for varying on the line description. Instead of specifying *LIN for the WRKCFGSTS command, you must specify *CTL.

Start the TCP/IP interface:

To enable the interface, use iSeries Navigator to do these steps:

1. In iSeries Navigator, expand the server that contains the TCP/IP interface to start.
2. Select **Network** → **Protocol**.
3. Right-click **TCP/IP** and select **Interface**.
4. You can start the interface now, or every time TCP/IP starts.
 - a. **To start the interface now:**
 - 1) Select an inactive interface.
 - 2) Click **Start**.
 - 3) Click **OK** to close the dialog box.
 - b. **To start the interface every time TCP/IP starts:**
 - 1) Double-click the interface.
 - 2) Select **Start interface when TCP/IP is started**.
 - 3) Click **OK**.

View the address of your LAN IOA

When configuring a controller description, you must specify the address of the remote input/output adapter (IOA).

On the remote system, use these procedures to view the locally administered address or the preset address:

View the locally administered address:

To view the locally administered address, do these steps:

1. Type DSPLIND *description_name* (where *description_name* is the name of the description to be displayed) and press Enter.
2. Locate the Local adapter address field to view the address of the adapter.
3. Press F3 (Exit).

View the preset address:

To view the preset address of the remote IOA, do these steps:

1. Locate a line description that uses the IOA. This description must specify *ADPT in the Adapter address field. If you cannot find such a line description, create it, and then return here to continue the steps.
2. Use the Work with ConfigurationStatus (WRKCFGSTS) command to vary on the line description:
 - a. Type WRKCFGSTS *LIN and press Enter.
 - b. Locate your line description and look for a status of varied on or active.
 - c. If it is varied on or active, press F3 (Exit) and skip to step 3.
 - d. Place your cursor on the Opt field of the line description, type 1 (Vary on), and press Enter.
 - e. If your line description does not vary on, place your cursor on the error message and press F1 (Help) to view more information about the error. If you need help to understand the error message or to resolve it, see Getting started with system troubleshooting.
 - f. Press F3 (Exit).
3. Type DSPLIND *description_name* (where *description_name* is the name of your line description), and press Enter.
4. Locate the Local adapter address field to view the preset address of the adapter.
5. Press F3 (Exit).

Configuration object commands

You can view and use other commands that affect your line, controller, or device descriptions by using the GO command.

To view configuration objects, use these commands:

- To view line description commands, type GO CMDLIND and press Enter.
- To view controller description commands, type GO CMDCTLD and press Enter.
- To view device description commands, type GO CMDDEVD and press Enter.

The following list shows other related commands that you can use with your descriptions. To use one of these commands, type the name of the command (that is shown in parentheses) and press F4 (Prompt):

- Retrieve Configuration Status (RTVCFGSTS)
- Vary Configuration (VRYCFG)
- Save Configuration (SAVCFG)
- Restore Configuration (RSTCFG)

- Work with Configuration Status (WRKCFGSTS)

Tune token-ring performance

You can improve the performance of your connections by adjusting related token-ring parameters.

- Adjust token-ring frame size.
- Adjust token-ring timing.
- Adjust token release timing. For 16 Mbps token-rings that use half duplex, you can increase performance by changing the token-release value in the token-ring line description. See Early token release.

Other performance tips:

See this information for other tips that might improve the performance of the connection:

- You can find other tips in the chapter about communication performance in iSeries Performance Capabilities Reference . The Web site has PDF files that contain the Performance Capabilities Reference. To use the Performance Capabilities Reference, you must download the file by clicking on a link and viewing it on your system.
- Read other tips for using Systems Network Architecture (SNA) over your LAN protocol in Improving LAN performance.

Adjust your LAN-frame size

If the remote bridge drops your frames, you might need to adjust your LAN-frame size.

When the remote bridge drops your frames, change your frame size:

1. Determine the new frame size. The network administrator should know what your frame size should be. You might also find that the frame size is contained within the QSYSOPR message queue in message CPF 5908. See “View QSYSOPR or other message queues”
2. Determine which configuration object and MAXFRAME parameter to change. To determine this, see “Bridges dropping frames” on page 25.
3. To change the parameter, see this information to determine which command to use:
 - **Change line description commands:**
 - Use the CHGLINTRN command for token-ring line descriptions.
 - **Change controller description commands:**
 - On an empty command line, type GO CMDCTL, and press Enter.
 - Enter the appropriate command into the command line, and press Enter.
 - Type the name of your controller, and press Enter.See “Token-ring line description commands” on page 25 for instructions on how to use the change line description commands.
4. Press F9 to show all parameters.
5. Locate the MAXFRAME parameter that you chose in step 2.
6. Specify the value that you found in step 1.
7. Press Enter to save your changes and exit the command.

View QSYSOPR or other message queues

QSYSOPR and other message queues contain messages that describe the error and might contain possible solutions for the error. These messages are typically a good place to begin your troubleshooting.

To view these messages, follow these steps:

1. Type `DSPMSG MSGQ(message_queue)` on the command line and press Enter, where message queue is `QSYSOPR` or the configured message queue.
2. Locate the error messages created around the time the error occurred.
3. Move your cursor to the error message of interest and press F1. The system displays more information about the error.
4. Note the cause code, the error's description, and possible solutions. Also, record any message IDs, error codes, reference codes, or reason codes.

Bridges dropping frames

A remote bridge discards your frame if it does not support your frame size. Also, the network can discard your frame if it does not support your frame size.

In a token-ring environment, the bridge informs the system that originated the connection of the supported frame sizes. The system then automatically tries to reconnect with that frame size.

If you cannot configure the bridge to support your frame size or a larger frame size, adjust the `MAXFRAME` parameter to a value that is acceptable to the bridge. The system has these `MAXFRAME` parameters that are shown in order of precedence:

1. The source service access point (SSAP) `MAXFRAME` parameter in the line description.
2. The `MAXFRAME` parameter in the line description (except Ethernet line descriptions).
3. The `MAXFRAME` parameter in the controller description.

The SSAP `MAXFRAME` parameter affects only one device. That is, only that device will use a frame size of SSAP `MAXFRAME`.

The `MAXFRAME` parameter that is in the line description affects all devices that use that description.

The `MAXFRAME` parameter that is in the controller description affects all lines and devices that use that description.

You set the precedence when specifying a `MAXFRAME` value. If you define a value for the first parameter (SSAP `MAXFRAME`) and then the second parameter, your system uses the value of the first parameter. To use the value of the second parameter, you should not specify a value for the first parameter.

Token-ring line description commands

You can create, change, delete, and display your token-ring line description.

- To create your line description, see "Create the token-ring line description" on page 7.
- To change or view your line description:
 1. Type `CHGLINTRN` on the command line, and press Enter.
 2. Type in the name of your description, and press Enter.
 3. Make your changes.
 4. Press Enter to save your changes, and exit the command.
- To delete your description use the Delete Line Description (`DLTLIND`) command. Type the statement below on the command line, and press Enter:

```
DLTLIND (description)
```

 Where description is the name of your description.
- To display your line description, type the statement below on the command line, and press Enter:

```
DSPLIND LIND(description)
```

 Where description is the name of your description.

Timing

Timing parameters are related to LAN performance. You can perform timing adjustments to improve LAN performance.

Timing parameters

You can make timing adjustments through the parameters of the Systems Network Architecture (SNA) controller description.

SNA controller descriptions (advanced program-to-program communication (APPC), SNA host, remote workstation, finance, and retail) have parameters that describe the behavior of the station. The parameters can be used with all LAN protocols. The names of these parameters begin with the letters LAN.

The table below shows the LAN parameters and their default values (see the *CALC column). You can view all parameter values with the Display Controller Description (DSPCTLD) command when the controller is varied on. You can find how a parameter affects your connection's performance by clicking on the link that is in the table below.

Note: Reducing a parameter's value gives you quicker error detection, but it also reduces the time for error recovery.

To change these parameters, see "Change timing parameters" on page 30.

Parameter	Description	*CALC value
LANCNTMR	(LAN connection timer) The time to wait between requests to connect.	7 seconds
LANCNRTRY	(LAN connection retry) The number of times to poll for request to connect.	10
LANRSPTMR	(LAN response timer) The time to wait before retransmitting a frame.	1 second
LANFRMRTY	(LAN frame retry) The number of times to retransmit a frame.	10
LANACKTMR	(LAN acknowledge timer) The time to wait before sending an acknowledgment.	0.1 seconds
LANACKFRQ	(LAN acknowledgment frequency) The number of frames to receive before sending an acknowledgment.	1
LANINACTMR	(LAN inactivity timer) The time to wait before requesting a response from the remote station.	10 seconds
LANMAXOUT	(LAN maximum outstanding) The number of outstanding frames allowed before requesting an acknowledgment from the remote station.	2
LANWDWSTP	(LAN window step) An alternative to LANMAXOUT. Use LANWDWSTP to help alleviate network congestion.	*NONE
LANACPTY	(LAN access priority) The priority of the station. Stations with higher priority have greater access to the token. (Used for token-ring only.)	0

The LANCNTMR and LANCNRTRY parameters:

Your Systems Network Architecture (SNA) controller description has two parameters: LAN connection timer (LANCNTMR) and LAN connection retry (LANCNRTRY). They work together to define the frequency and persistence of polling the remote station to establish a connection.

LANCNNTMR specifies how long to wait before polling again. LANCNNRTY specifies how many times to poll. If the system receives no response from the remote station after polling the number of times specified in the LANCNNRTY parameter, the following occurs:

- The user is notified that contact with the station was unsuccessful.
- The system places the controller description in answer mode.
- If the remote station signals your system to try your connection inquiry again, your system attempts to establish connection again.

Performance problems:

The default values of the parameters are designed for a single LAN and might cause a connection failure when you access a remote station through a remote bridge. The bridge might slow data traffic enough that the connection timer expires before the remote station's response reaches you. If this is the case, you should increase the values of LANCNNTMR and LANCNNRTY.

To change these parameters, see "Change timing parameters" on page 30.

The LANRSPTMR and LANFRMRTY parameters:

In your Systems Network Architecture (SNA) controller description, the LAN response timer (LANRSPTMR) and the LAN frame retry (LANFRMRTY) parameters work together to determine how soon and how often the system retransmits a frame.

LANRSPTMR defines how long to wait before retransmitting a frame to the remote station. LANFRMRTY specifies how many times to retransmit a frame. A system retransmits a frame when one of the following situations occurs:

- A frame was lost or damaged.
- The remote station does not respond because it is busy.
- The remote station is waiting to acknowledge the frame with an information frame of its own. (See LANACKTMR and LANACKFRQ for more information about the acknowledge timer).

After your system retransmits a frame a number of times (based on the number that is indicated by the LANFRMRTY parameter), the system notifies the user that an error occurred and disconnects itself from the remote station.

Performance problems:

The default values of the parameters are designed for a single LAN and can cause too many frame retransmissions when accessing a remote station through a remote bridge. The bridge might slow data traffic enough that your retransmit timer expires before the remote station's acknowledgment reaches you. Eventually, your system automatically disconnects itself because it retransmitted a frame too many times. If this is the case, you should increase the values of LANRSPTMR and LANFRMRTY.

Note: If you make the parameter values too large, your connection failure notices can be delayed.

Related tasks

"Change timing parameters" on page 30

You can change timing parameters to improve LAN performance.

The LANACKTMR and LANACKFRQ parameters:

Your Systems Network Architecture (SNA) controller description includes the LAN acknowledgment timer (LANACKTMR) and the LAN acknowledgment frequency (LANACKFRQ) parameters. They work together to determine how often to send an acknowledgment to the remote station.

LANACKTMR specifies how long the system waits before sending an acknowledgment for the frames that it received. LANACKFRQ specifies the maximum number of frames that your system receives before sending an acknowledgment to the remote station (independent of timers or having data to send). Your system has a greater chance of sending the acknowledgment in a data frame (rather than the acknowledgment by itself) if the LANACKFRQ value is large.

Performance problems:

Large values for LANACKTMR and LANACKFRQ might be what you want because smaller values can cause unnecessary acknowledgments and contribute to heavier LAN traffic. If you are connected to a network with traffic problems, you can increase the values of either parameters or both parameters.

However, in most cases where LAN traffic is not a problem and data tends to flow one way, large parameter values can cause this to happen:

- Introduce unnecessary delays when sending acknowledgments.
- Slow response times.

LANACKTMR considerations:

You should choose values for the LANACKTMR parameter by carefully considering the remote station's response timer (LANRSPTMR) and maximum outstanding frame count (LANMAXOUT).

For example, assume that your system cannot send an acknowledgment before the remote station's response timer expires. The remote station will retransmit its frame because it did not receive your acknowledgment. To solve this problem, you must either shorten your system's timer or lengthen the remote system's timer.

LANACKFRQ considerations:

Similarly, you should choose values for LANACKFRQ by carefully considering the remote station's maximum outstanding frame count (LANMAXOUT). If you do not correctly adjust the counters, your system will wait for more frames. However, the remote station will not transmit them because it is waiting for an acknowledgment from your system.

To change these parameters, see "Change timing parameters" on page 30.

The LANINACTMR parameter:

The LAN inactivity timer (LANINACTMR) parameter of your Systems Network Architecture (SNA) controller description determines how long your system waits before requesting a response from the remote station. Your system uses the request to test if the remote station is still accessible.

Performance problems:

Unnecessary traffic is created if the value that you specify for the LANINACTMR parameter is too small. This might lead to a performance throughput problem. If it is too large, your system might not find out as quickly that the remote station is inaccessible.

LANINACTMR is sensitive to whether the remote station is on the same LAN or not. If the station is across a bridge, you might need to increase this value. If the value is 0 (no time out), you will not be informed if the connection fails until your system attempts a data transfer.

To change these parameters, you should see "Change timing parameters" on page 30.

The LANMAXOUT parameter:

The Maximum outstanding data frames (LANMAXOUT) parameter of your Systems Network Architecture (SNA) controller description specifies how many frames your system sends before waiting to receive an acknowledgment.

The LANMAXOUT parameter is highly sensitive to the remote station's speed to copy and acknowledge frames (speed is based on buffering capabilities and processing resource).

Note: The LAN window step (LANWDWSTP) parameter can influence the number of outstanding frames.

Performance problems:

For optimal performance, you must choose appropriate values for the LANMAXOUT and LANACKFRQ parameters on both the sending and receiving stations.

These variables affect which LANMAXOUT and LANACKFRQ values provide the best performance:

- The characteristics of the application.
- The amount of data sent.
- The rate that the application can present and accept data.
- The data blocking characteristics.
- The LAN adapter type.
- The processing unit model.
- The utilization of the line, the adapter, and the processing unit.
- The internal buffering capabilities.

In most environments, the default value (*CALC) for LANACKFRQ and LANMAXOUT offer the best performance. However, for some environments, changing the values can improve performance significantly.

If you want to change LANMAXOUT, see "Change timing parameters" on page 30.

The LANWDWSTP parameter:

The LAN window step (LANWDWSTP) parameter of your Systems Network Architecture (SNA) controller description determines whether the number of outstanding frames are reduced during network congestion.

Parameter LANMAXOUT determines the initial value for the number of outstanding frames.

Performance problems:

If the value for LANWDWSTP parameter is too small or is *NONE, the network congestion takes longer to subside. For more information about network congestion, see the discussion of the dynamic window algorithm in the manual *Token-Ring Network Architecture Reference*, SC30-3374.

To change these parameters, see "Change timing parameters" on page 30.

The LANACCPTY parameter:

The LAN access priority (LANACCPTY) parameter of your Systems Network Architecture (SNA) controller description determines a token's priority.

Performance problems:

The higher the priority, the greater the chances are that the remote station will quickly receive the token. The greater the access priority value, the more tokens the remote station receives. The greater value also increases your system's chances for sending its frame. These considerations are important if your system accesses a heavily used ring (not many free tokens available) and your application program needs priority treatment.

To change these parameters, see "Change timing parameters."

Change timing parameters

You can change timing parameters to improve LAN performance.

To change the LAN parameters, follow these steps:

1. To view a list of commands that can change your controller description, type GO CMDCHG and press Enter.
2. From the displayed list of commands, choose a command to change your controller description.
3. Type the command and press Enter.
4. Change the LAN parameters that you have chosen.
5. Press Enter to save your changes.

Related concepts

"The LANRSPTMR and LANFRMRTY parameters" on page 27

In your Systems Network Architecture (SNA) controller description, the LAN response timer (LANRSPTMR) and the LAN frame retry (LANFRMRTY) parameters work together to determine how soon and how often the system retransmits a frame.

Troubleshoot token ring

The server has tools to help you locate and resolve errors.

This information shows the tools that you can use and other troubleshooting help:

- Find your troubleshooting tools in Troubleshoot LANs.
- If your system or the remote system cannot successfully connect, read Why some LAN connections fail for possible causes and solutions.
- If the PCs cannot connect to your system, see Why PCs do not connect to your system.
- If you are tracing LAN communications, you might need to know the format of the token-ring frame to correctly understand the information it contains. If so, see Understand the token-ring address format.

Connection problems when using the 2744 card:

If you have problems making a connection with the 2744 card, the automatic ring-speed sensing setting might be incorrectly configured. If this is the case, you should verify that only the line description or the switch to which your system connects is enabled for automatic sensing. That is, only one device must be enabled for automatic sensing. The other device should manually indicate the speed it can use.

Troubleshoot LANs

Your server has tools to help you quickly find the problem and possible solutions.

For an overview of the tools of your system and instructions on how to use the tools, see Getting started with system troubleshooting.

Also, Communications trace can be used to trace network data to locate a problem.

IBM also provides a Web site that might contain solutions for you, see Global iSeries Technical support



Why some LAN connections fail

Sometimes an incorrectly configured controller description can cause a connection failure.

The cases here involve the incorrect configuration of the adapter address, source service access point (SSAP), or destination service access point (DSAP) parameters.

For more information about how these parameters influence a successful connection, see How LAN devices identify themselves. For other causes of a connection failure, see Which device initiates the connection.

The remote system does not connect:

If your controller description uses dial mode, it is not unusual for the system to receive message CPA58E0 (Controller not replying) or CPA57EF (Contact not successful). Remote systems or controller descriptions that do not vary on can cause one of these messages to appear.

Your system does not connect:

If your controller description uses answer mode, you might receive the message CPI591A (Controller is online, varied off, or not recognized by the local system). There are some things that can cause this message to appear:

- The connection requested by the remote system does not exist on the local system. The local system searches for this connection (that is indicated by combining the local adapter address, the DSAP, and the SSAP) in all varied-on controller descriptions.
- The controller description does not refer to the line description that can answer the call.

Solution:

To correct any of the above problems, do one or more of these steps:

- On either side of the connection, verify that the controller description has the correct combination of adapter address, SSAP, and DSAP.
- Enter the line description that can accept the call into the Switched line list field of the controller description. See Understanding connection establishment for information about the relationship between line descriptions and controller descriptions.
- Vary on the correct controller description (use the Work with Configuration Status (WRKCFGSTS) command to vary on the controller).
- Verify that the local and remote adapters are wired into the network correctly.

Why PCs do not connect to your system

If the PCs cannot connect to your server, view the error log for messages about line descriptions and about system reference code AF06.

The reasons why PCs do not connect to your system might be:

- The remote device is polling your system.
- The system operator message queue does not contain a message about the system being polled.
- The connection is not established.

You can verify that the above condition occurred by looking in the error log. Use the Start System Service Tools (STRSST) command to look in your error log. To view this log, see Displaying the Product Activity Log.

The above condition can occur if the remote device uses a destination service access point (DSAP) that your line description does not refer to. The condition can also occur if the line description that contains the correct DSAP, is not in the Switched line list field of the correct controller description. Even if the AF06 system reference code is absent, the error might have occurred. You can resolve this problem by verifying that the adapter address, Source service access point (SSAP), and DSAP values at both ends of the connection are correct.

Understand the token-ring address format

While troubleshooting, you might need to view the information of the destination-address and source-address frames.

These are the formats of the frames:

Destination address format:

This figure shows the destination address format:

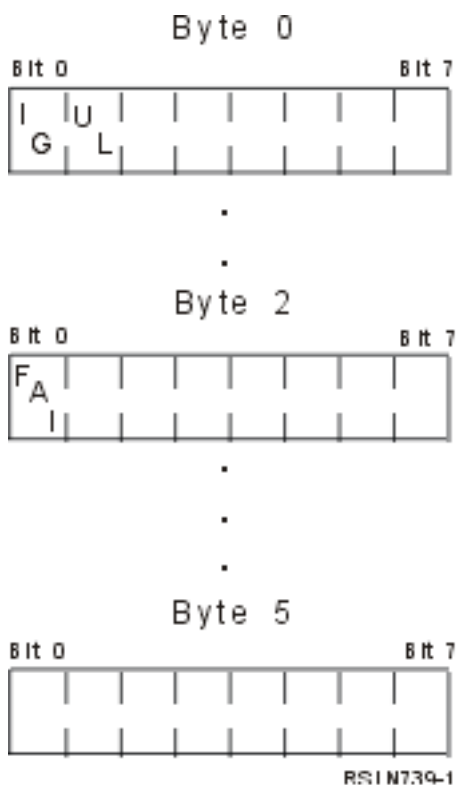

Figure 2. Destination address format

Some of the bits indicate the characteristics of the destination address:

- **I/G bit (bit 0 of byte 0)** indicates the type (individual or group) of the destination address. These are the possible values for this bit:
 - 0: The destination address is an individual address (an address that is associated with a device on the network).

- 1: The destination address is a group address (a multiple destination address that is associated with one or more devices on the network).
- **U/L bit (bit 1 of byte 0)** indicates who defined the address. These are the possible values for this bit:
 - 0: The manufacturer defined the address (it is a universally administered address or in other words a burned-in address).
 - 1: The administrator defined the address (it is a locally administered address).
- **Functional address indicator (FAI) bit (bit 0 of byte 2)** indicates the address type of the locally administered address. These are the possible values for this bit:
 - 0: The address is a functional address.
 - 1: The address is a group address.

Source address format:

A source address is always an individual address (that is, an address that is associated with a device on the network). This figure shows the format of the address:

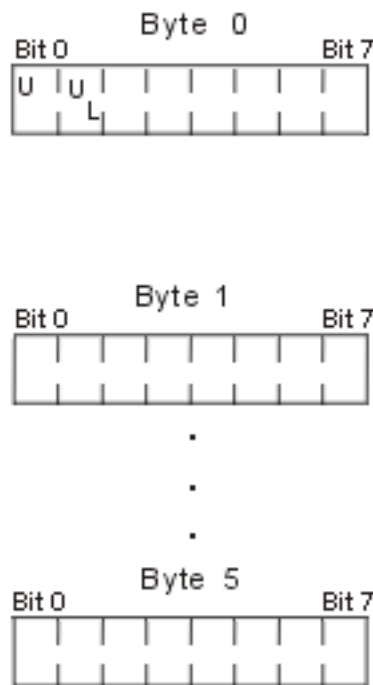

Figure 3. Source address format

Some of the bits indicate the type of address that the source address contains:

- **Bit 0 of byte 0** indicates whether or not the frame contains a routing information field. These are the possible values for this bit:
 - 0: The routing information field is present.
 - 1: The routing information field is not present.
- **Bit 1 of byte 0** indicates the type of the address. These are the possible values for this bit:
 - 0: The address is a universally administered address. Because this bit is 0, the burned-in address cannot be greater than X'7FFFFFFFFF'.
 - 1: The address is a locally administered address. Because this bit is 1, the group address must be greater than X'800000000000'.

Code license and disclaimer information

IBM grants you a nonexclusive copyright license to use all programming code examples from which you can generate similar function tailored to your own specific needs.

| SUBJECT TO ANY STATUTORY WARRANTIES WHICH CANNOT BE EXCLUDED, IBM, ITS
| PROGRAM DEVELOPERS AND SUPPLIERS MAKE NO WARRANTIES OR CONDITIONS EITHER
| EXPRESS OR IMPLIED, INCLUDING BUT NOT LIMITED TO, THE IMPLIED WARRANTIES OR
| CONDITIONS OF MERCHANTABILITY, FITNESS FOR A PARTICULAR PURPOSE, AND
| NON-INFRINGEMENT, REGARDING THE PROGRAM OR TECHNICAL SUPPORT, IF ANY.

| UNDER NO CIRCUMSTANCES IS IBM, ITS PROGRAM DEVELOPERS OR SUPPLIERS LIABLE FOR
| ANY OF THE FOLLOWING, EVEN IF INFORMED OF THEIR POSSIBILITY:

- | 1. LOSS OF, OR DAMAGE TO, DATA;
- | 2. DIRECT, SPECIAL, INCIDENTAL, OR INDIRECT DAMAGES, OR FOR ANY ECONOMIC
| CONSEQUENTIAL DAMAGES; OR
- | 3. LOST PROFITS, BUSINESS, REVENUE, GOODWILL, OR ANTICIPATED SAVINGS.

| SOME JURISDICTIONS DO NOT ALLOW THE EXCLUSION OR LIMITATION OF DIRECT,
| INCIDENTAL, OR CONSEQUENTIAL DAMAGES, SO SOME OR ALL OF THE ABOVE LIMITATIONS
| OR EXCLUSIONS MAY NOT APPLY TO YOU.

Appendix. Notices

This information was developed for products and services offered in the U.S.A.

IBM may not offer the products, services, or features discussed in this document in other countries. Consult your local IBM representative for information on the products and services currently available in your area. Any reference to an IBM product, program, or service is not intended to state or imply that only that IBM product, program, or service may be used. Any functionally equivalent product, program, or service that does not infringe any IBM intellectual property right may be used instead. However, it is the user's responsibility to evaluate and verify the operation of any non-IBM product, program, or service.

IBM may have patents or pending patent applications covering subject matter described in this document. The furnishing of this document does not grant you any license to these patents. You can send license inquiries, in writing, to:

IBM Director of Licensing
IBM Corporation
North Castle Drive
Armonk, NY 10504-1785
U.S.A.

For license inquiries regarding double-byte (DBCS) information, contact the IBM Intellectual Property Department in your country or send inquiries, in writing, to:

IBM World Trade Asia Corporation
Licensing
2-31 Roppongi 3-chome, Minato-ku
Tokyo 106-0032, Japan

The following paragraph does not apply to the United Kingdom or any other country where such provisions are inconsistent with local law: INTERNATIONAL BUSINESS MACHINES CORPORATION PROVIDES THIS PUBLICATION "AS IS" WITHOUT WARRANTY OF ANY KIND, EITHER EXPRESS OR IMPLIED, INCLUDING, BUT NOT LIMITED TO, THE IMPLIED WARRANTIES OF NON-INFRINGEMENT, MERCHANTABILITY OR FITNESS FOR A PARTICULAR PURPOSE. Some states do not allow disclaimer of express or implied warranties in certain transactions, therefore, this statement may not apply to you.

This information could include technical inaccuracies or typographical errors. Changes are periodically made to the information herein; these changes will be incorporated in new editions of the publication. IBM may make improvements and/or changes in the product(s) and/or the program(s) described in this publication at any time without notice.

Any references in this information to non-IBM Web sites are provided for convenience only and do not in any manner serve as an endorsement of those Web sites. The materials at those Web sites are not part of the materials for this IBM product and use of those Web sites is at your own risk.

IBM may use or distribute any of the information you supply in any way it believes appropriate without incurring any obligation to you.

Licensees of this program who wish to have information about it for the purpose of enabling: (i) the exchange of information between independently created programs and other programs (including this one) and (ii) the mutual use of the information which has been exchanged, should contact:

IBM Corporation

Software Interoperability Coordinator, Department YBWA
3605 Highway 52 N
Rochester, MN 55901
U.S.A.

Such information may be available, subject to appropriate terms and conditions, including in some cases, payment of a fee.

- | The licensed program described in this information and all licensed material available for it are provided
- | by IBM under terms of the IBM Customer Agreement, IBM International Program License Agreement,
- | IBM License Agreement for Machine Code, or any equivalent agreement between us.

Any performance data contained herein was determined in a controlled environment. Therefore, the results obtained in other operating environments may vary significantly. Some measurements may have been made on development-level systems and there is no guarantee that these measurements will be the same on generally available systems. Furthermore, some measurements may have been estimated through extrapolation. Actual results may vary. Users of this document should verify the applicable data for their specific environment.

Information concerning non-IBM products was obtained from the suppliers of those products, their published announcements or other publicly available sources. IBM has not tested those products and cannot confirm the accuracy of performance, compatibility or any other claims related to non-IBM products. Questions on the capabilities of non-IBM products should be addressed to the suppliers of those products.

All statements regarding IBM's future direction or intent are subject to change or withdrawal without notice, and represent goals and objectives only.

This information contains examples of data and reports used in daily business operations. To illustrate them as completely as possible, the examples include the names of individuals, companies, brands, and products. All of these names are fictitious and any similarity to the names and addresses used by an actual business enterprise is entirely coincidental.

COPYRIGHT LICENSE:

This information contains sample application programs in source language, which illustrate programming techniques on various operating platforms. You may copy, modify, and distribute these sample programs in any form without payment to IBM, for the purposes of developing, using, marketing or distributing application programs conforming to the application programming interface for the operating platform for which the sample programs are written. These examples have not been thoroughly tested under all conditions. IBM, therefore, cannot guarantee or imply reliability, serviceability, or function of these programs.

Each copy or any portion of these sample programs or any derivative work, must include a copyright notice as follows:

© (your company name) (year). Portions of this code are derived from IBM Corp. Sample Programs. © Copyright IBM Corp. _enter the year or years_. All rights reserved.

If you are viewing this information softcopy, the photographs and color illustrations may not appear.

Programming Interface Information

This Token ring publication documents intended Programming Interfaces that allow the customer to write programs to obtain the services of IBM i5/OS.

Trademarks

The following terms are trademarks of International Business Machines Corporation in the United States, other countries, or both:

- | e(logo)server
- | eServer
- | IBM
- | IBM (logo)
- | i5/OS
- | iSeries
- | Netfinity
- | System/36
- | VTAM
- | xSeries

Other company, product, and service names may be trademarks or service marks of others.

Terms and conditions

Permissions for the use of these publications is granted subject to the following terms and conditions.

Personal Use: You may reproduce these publications for your personal, noncommercial use provided that all proprietary notices are preserved. You may not distribute, display or make derivative works of these publications, or any portion thereof, without the express consent of IBM.

Commercial Use: You may reproduce, distribute and display these publications solely within your enterprise provided that all proprietary notices are preserved. You may not make derivative works of these publications, or reproduce, distribute or display these publications or any portion thereof outside your enterprise, without the express consent of IBM.

Except as expressly granted in this permission, no other permissions, licenses or rights are granted, either express or implied, to the publications or any information, data, software or other intellectual property contained therein.

IBM reserves the right to withdraw the permissions granted herein whenever, in its discretion, the use of the publications is detrimental to its interest or, as determined by IBM, the above instructions are not being properly followed.

You may not download, export or re-export this information except in full compliance with all applicable laws and regulations, including all United States export laws and regulations.

IBM MAKES NO GUARANTEE ABOUT THE CONTENT OF THESE PUBLICATIONS. THE PUBLICATIONS ARE PROVIDED "AS-IS" AND WITHOUT WARRANTY OF ANY KIND, EITHER EXPRESSED OR IMPLIED, INCLUDING BUT NOT LIMITED TO IMPLIED WARRANTIES OF MERCHANTABILITY, NON-INFRINGEMENT, AND FITNESS FOR A PARTICULAR PURPOSE.



Printed in USA