



IBM Systems - iSeries
Systems management
Logical Partitions

Version 5 Release 4





IBM Systems - iSeries
Systems management
Logical Partitions

Version 5 Release 4

Note

Before using this information and the product it supports, read the information in “Notices,” on page 141.

Fifth Edition (February 2006)

This edition applies to version 5, release 4, modification 0 of and IBM i5/OS (product number 5722-SS1) to all subsequent releases and modifications until otherwise indicated in new editions. This version does not run on all reduced instruction set computer (RISC) models nor does it run on CISC models.

© Copyright International Business Machines Corporation 2004,2006. All rights reserved.

US Government Users Restricted Rights – Use, duplication or disclosure restricted by GSA ADP Schedule Contract with IBM Corp.

Contents

Logical partitions.	1
Partitioning with an iSeries Server	1
Printable PDF	1
Logical partition concepts	2
Logical and guest partition scenarios	32
Plan for logical partitions.	40
Create logical partitions	56
Manage logical partitions.	58
Troubleshoot logical partitions	91

Partitioning with an eServer i5	138
Related information for logical partitions	138
Code license and disclaimer information	139

Appendix. Notices 141

Programming Interface Information	143
Trademarks	143
Terms and conditions.	143

Logical partitions

Logical partitions allow you to distribute resources within a single iSeries™ server to make it function as if it were two or more independent servers. Plan your next upgrade to include logical partitions.

Select the appropriate logical partition information based on the hardware you own.

Note: Read the Code license and disclaimer information for important legal information.

Partitioning with an iSeries Server

Use this information if you plan to use iSeries Navigator for managing i5/OS™ logical partitions.

This information steps you through the logical partition process, from creation to management.

Printable PDF

Use this to view and print a PDF of this information.

To view or download the PDF version of this document, select Logical partitions (about 180 KB).

You can view or download these related topics:

- Linux® in a guest partition
- Backup and recovery
- Capacity on Demand
- Install the i5/OS release and related software

IBM® Redbooks™

You can also view or print any of the following PDFs:

- Slicing the AS/400® with Logical Partitioning: A How to Guide



(about 2.7 MB)

This guide discusses the logical partitioning revolution on the iSeries server. It is designed for all levels of understanding. It includes an overall view of logical partitioning. It also includes technical information for people who will be actively engaged in devising solutions that involve logical partitioning, creating partitioned machines, and managing and operating them.

- LPAR Configuration and Management Working with iSeries Logical Partitions



(about 7.2 MB)

This IBM Redbook documents V5R1 LPAR planning and implementing considerations. It looks at various scenarios that implement LPAR. This redbook compliments the LPAR information provided in the iSeries Information Center.

- Linux on the IBM iSeries Server: An Implementation Guide



(about 4.6 MB)

This IBM Redbook begins with an overview of Linux, defines what open source means, and explains why using Linux on iSeries is beneficial. It discusses the basic system administration tasks and Linux application development to help you manage your system and develop Linux applications on the iSeries server. It also introduces a wide range of services, such as Firewall, Apache, Samba, and e-mail, and explains the capabilities of each.

Web sites

- Logical Partitions
- Linux on iSeries

Saving PDF files

To save a PDF on your workstation for viewing or printing:

1. Right-click the PDF in your browser (right-click the link above).
2. Click the option that saves the PDF locally.
3. Navigate to the directory in which you want to save the PDF.
4. Click **Save**.

Downloading Adobe Reader

- 1 You need Adobe Reader installed on your system to view or print these PDFs. You can download a free copy from the Adobe Web site (www.adobe.com/products/acrobat/readstep.html).

Logical partition concepts

Use this information to get the technical facts about logical partitions to find out what you need to know about your hardware, and to discover the multiple uses you can get from logical partitions.

The iSeries server offers you the ability to partition one server into several independent servers. Before you start creating partitions, it is essential that you understand the concepts behind this type of system configuration. The purpose of this topic is to familiarize you with the hardware and software required for logical partitions and to prepare you to plan and create logical partitions on your iSeries.

Related concepts

“Plan for logical partitions” on page 40

Understand the hardware and software requirements needed to successfully implement logical partitions. Read and go through the preorder tasks of completing the planning work sheet.

“Manage logical partitions” on page 58

Find all the information you need to manage your logical partitions. Access your logical partition information, and find instructions on restarting and powering down individual logical partitions.

Also, use the information to change your logical partition configuration, manage security, and change processing resources.

How logical partitioning works

Understand the meaning of a logical partitioned system and how primary and secondary partitions operate as independent servers.

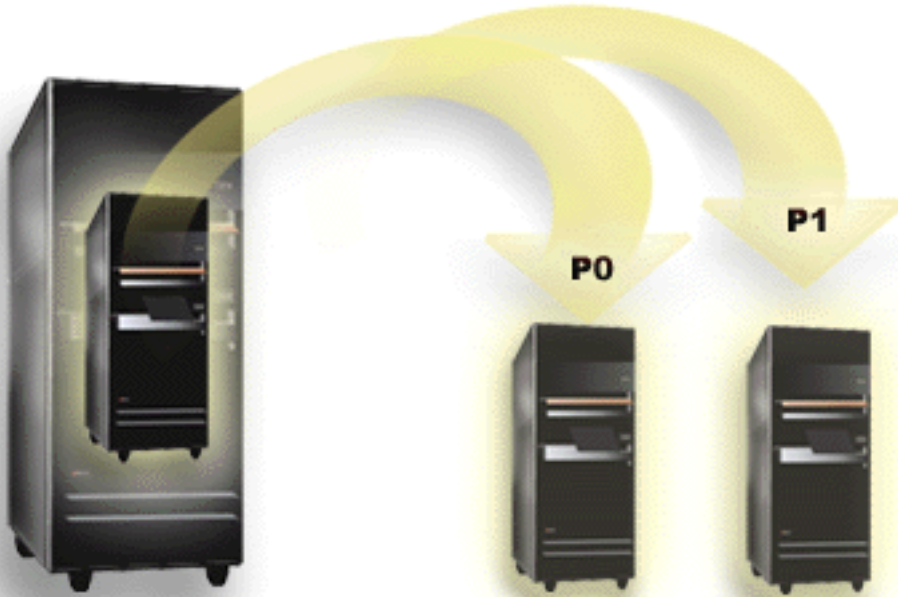

Logical partitioning is the ability to make an iSeries server run as if it were two or more independent servers. Each logical partition operates as an independent logical server. However, each partition shares a few physical system attributes such as the system serial number, system model, and processor feature code. All other system attributes may vary among partitions.

Logical partitions fall into two categories, primary partitions or secondary partitions. Each logically partitioned system has one primary partition and one or more secondary partitions. The primary partition is the only partition prior to performing any configuration changes on a system. Before secondary partitions are created, all system resources are assigned to the primary partition. Secondary partitions are independent of each other. While each secondary partition maintains a dependency on the primary, it otherwise operates as a stand-alone server.

All management functions for partitions are integrated into the Licensed Internal Code of the primary partition.

When you perform a restart of the primary partition on a server with multiple partitions, the primary partition starts first. The primary partition owns certain system resources (the system operation panel, service processor, and system key lock). The primary partition can start (IPL) secondary partitions once the system validates these resources. If a processor, memory card, or system bus failure occurs, you can find system error log entries in the primary partition Product Activity Log.

The primary partition, essentially the partition manager for your server, must remain active for the secondary partitions to be active. It is important to plan carefully on how you operate the primary partition or the types of workload you run in the primary partition. For example, i5/OS commands such as Power Down System (PWRDWN SYS), operator panel functions such as 3, 8, or 22, applying fixes (PTFs) that require a restart will affect all of the secondary partitions. You may want to restrict the primary partition to simple partition management tasks only. Since all logical partition resource movement is achieved through use of the primary partition, the isolation of the primary partition provides a secure environment whereby users in secondary partitions are not able to move resources such as processor or memory without going through a logical partition administrator of the primary partition. Where primary partition isolation is not possible, you may want to think about implementing applications that require little or no maintenance, by not using it as a test partition.

Each logical partition represents a division of resources in your iSeries server. Each partition is logical because the division of resources is virtual, not along physical boundaries. The primary resources in your server are its processors, memory, buses, and IOPs. The following diagram shows the division of system resources on a server that has two partitions:

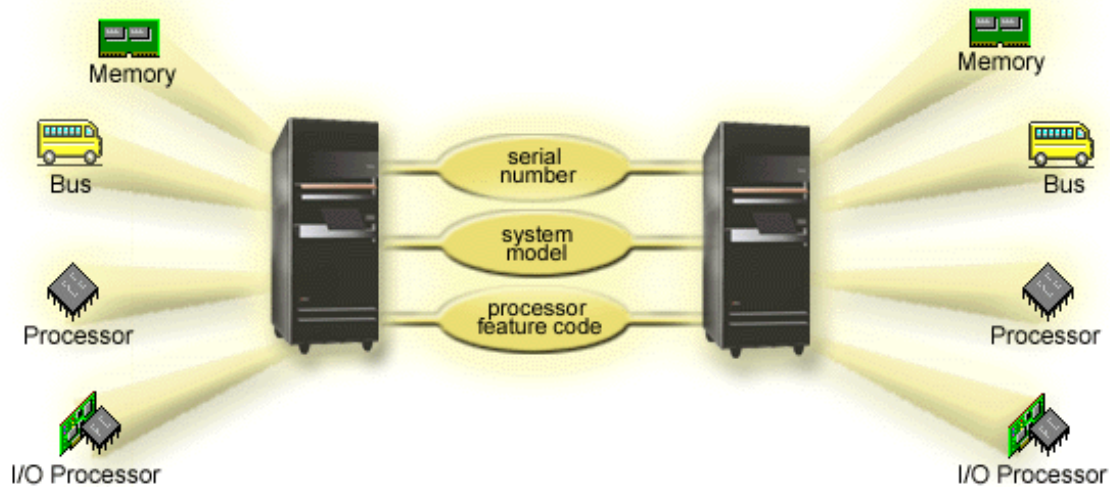

Related tasks

“View the Product Activity Log (PAL) for logical partitions” on page 109

Use Dedicated Service Tools (DST) or System Service Tools (SST) to find system reference codes for logical partitions.

How logical partitioning can work for you

Understand the advantages of partitioning your server and practical scenarios your company can use with this advanced technology.

Logical partitions on an iSeries server could prove beneficial in the following scenarios:

Creating a Mixed Production and Test Environment

You can create a combination production and test environment on the same server. You can use a logical partition as a test partition or a production partition. A production partition runs your main business applications. A failure in a production partition could significantly hinder business operations and cost the customer time and money. A test partition tests software. This might include i5/OS release testing. A failure in a test partition, while not necessarily planned, will not disrupt normal business operations.

Creating a Multiple Production Partition Environment

You create multiple production partitions in your secondary partitions. In this situation, you dedicate the primary partition to partition management.

Consolidation

A logically partitioned server can reduce the number of servers that are needed within an enterprise. You can consolidate several servers into a single logically partitioned system. This eliminates the need for, and expense of, additional equipment. You can shift resources from one logical partition to another as needs change.

Hot Backup

When a secondary partition replicates another logical partition within the same system, to switch to the backup during partition failure would cause minimal inconvenience. This configuration also minimizes the effect of long save windows. You can take the backup partition off line and save, while the other logical partition continues to perform production work. You will need special software to use this hot backup strategy.

Integrated Cluster

Using OptiConnect and high availability application software, your partitioned server can run as an integrated cluster. You can use an integrated cluster to protect your server from most unscheduled failures within a secondary partition.

Maintaining Independent Systems

Dedicating a portion of the resources (disk storage unit, processors, memory, and I/O devices) to a partition achieves logical isolation of software. Logical partitions also have some hardware fault tolerance if configured properly. Interactive and batch workloads which may not run well together on a single machine can be isolated and run efficiently in separate partitions.

Running Linux

You could consolidate several Linux servers to an iSeries server. Linux enhances iSeries flexibility by enabling another application environment. Linux applications can access DB2[®] UDB as well as i5/OS programs and services using virtual Ethernet.

Related concepts

“Logical and guest partition scenarios” on page 32

Read logical and guest partition scenarios to understand how a partitioned server can be configured and used.

“Determine the possible number of logical partitions” on page 41

The number of processors you want to add to a logical partition depends on the planned workload for the partition and the desired level of performance.

Hardware for logical partitions

Understand the basic hardware concepts and requirements to partition your server.

The information in this topic describes the required hardware needed on your server to successfully create a logical partition.

The ability to dynamically move resources between partitions is available on both AS/400 and iSeries models that support logical partitions. Uni-processor partitioning capability and shared processor pool capability is available on V5R1 and V5R2 partitions running on iSeries models 800, 810, 820, 825, 830, 840, 870, and some 270s. Other hardware for the logical partition is either optional, or you can switch it between two or more logical partitions.

You can read Plan for logical partitions to help you decide what hardware you need. To learn more about the hardware you can use with logical partitions, click the piece of hardware you want to learn more about in the following picture:

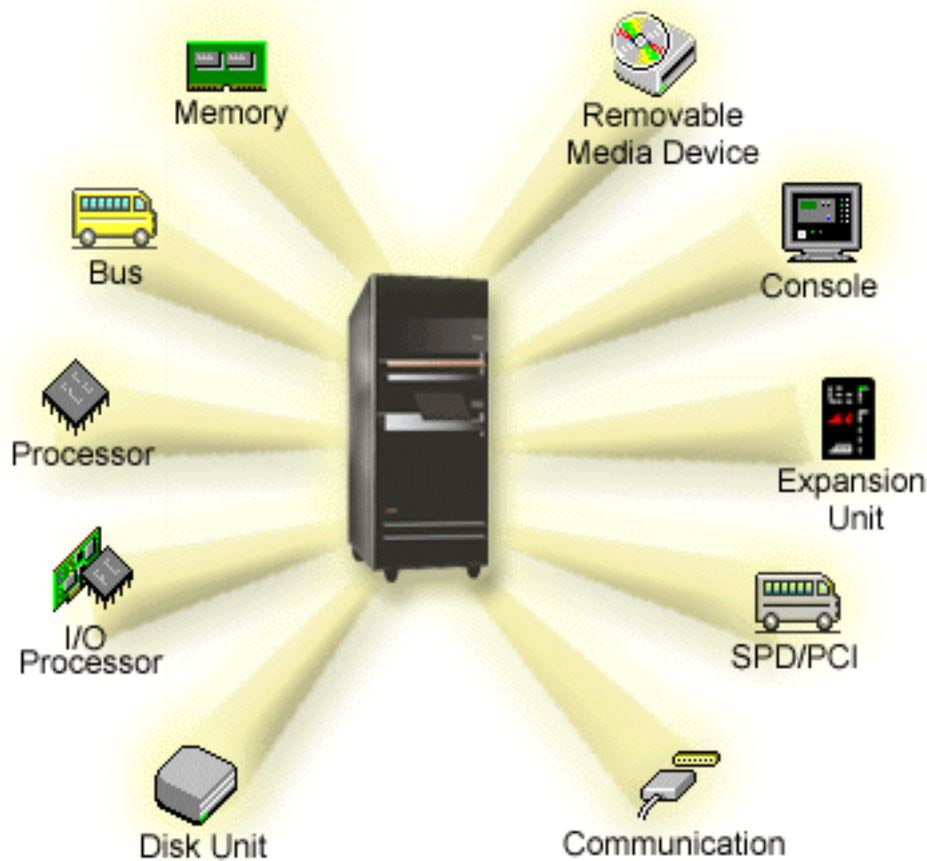

To display system hardware resources, follow these steps:

1. In iSeries Navigator, expand **My Connections** or your active environment.
2. Select the primary partition of the system.
3. Expand **Configuration and Service** and select **Logical Partitions**.
4. Right-click the **Logical Partition** and select **Configure Partitions**. You are now working in the Configure Logical Partitions window.
5. Select **Physical System** to view the hardware resources for the entire system.

Related concepts

“Plan for logical partitions” on page 40

Understand the hardware and software requirements needed to successfully implement logical partitions. Read and go through the preorder tasks of completing the planning work sheet.

“Logical partition concept: dedicated processor” on page 13

Dedicated processors are whole processors that are used exclusively by the partition to which they are assigned. The dedicated processor handles the processing for a specific logical partition.

“Logical partition concept: shared processor pool” on page 14

The shared processing pool allows you to assign partial processors to a logical partition.

“Logical partition concept: alternate restart (IPL) devices and removable media device” on page 17
A removable media device reads and writes to media (tape, CD-ROM, or DVD).

“Logical partition concept: console” on page 21

Each logical partition must have a console attached to it through an IOP.

“Logical partition concept: expansion unit” on page 21

You can add an expansion unit to many of the iSeries servers to support additional features and devices.

“Communication options for logical partitions” on page 29

Learn how logical partitions are able to share data between partitions or between servers.

Logical partition concept: bus:

A bus is a conductor that is used for transmitting signals or power.

A system I/O bus conducts instructions from memory to the devices that are attached to the input/output processors (IOPs). A system I/O bus also conducts instructions from the IOPs back to memory.

The main system unit contains one system I/O bus. The primary partition always uses bus 1. Secondary partitions can share this bus. Most expansion units contain at least one bus as well.

Every logical partition needs a bus which the logical partition can either own dedicated or shared with other logical partitions. Each logical partition can use (without owning) a system I/O bus. You can dynamically change which logical partition owns the bus or the type of bus ownership (shared or dedicated) provided the owning partition owns the bus shared.

It is possible to divide up your resources by system I/O bus when you create your logical partitions. This is called bus-level I/O partitioning. In this situation, you assign all resources (IOPs, IOAs, and devices) that are attached to the bus to only one logical partition.

It is also possible to share a bus and divide up the resources on the bus according to IOPs. This is called IOP-level I/O partitioning. In this situation, you assign all resources (IOAs and devices) that are attached to a single IOP to only one logical partition at a time. You may assign other IOPs attached to this same bus to any other (or to the same) logical partition.

When you add a bus to a logical partition, you must select whether to share the bus with other logical partitions. You have the following options for bus ownership type:

- Own dedicated: you assign all IOPs, resources, and empty card positions to the partition (bus-level I/O partitioning).
- Own bus shared: Some IOPs along with their empty card positions can be assigned go with the bus owner (IOP-level I/O partitioning).
- Use bus shared: Another logical partition lists the bus as own bus shared, but this logical partition also uses the bus. In this situation, the owning logical partition may experience slightly improved performance. Consider having the partition using high data transfer rate resources to own the bus.

You must assign the *own dedicated* type to any bus that contains the OptiConnect hardware.

From the Configure Logical partition window, you can view all of the buses on the system. You may perform concurrent maintenance from the owning logical partition (dedicated buses only) or from the primary partition. However, you must perform concurrent maintenance for shared buses from the primary partition.

Related concepts

“Logical partition concept: memory” on page 15

Processors use memory to temporarily hold information.

“Logical partition concept: IOP” on page 10

The IOP attaches to the system I/O bus and one or more input/output adapters (IOAs). The IOP processes instructions from the server and works with the IOAs to control the I/O devices.

“Logical partition concept: expansion unit” on page 21

You can add an expansion unit to many of the iSeries servers to support additional features and devices.

“Logical partition concept: Bus-level and IOP-level I/O partitions”

Depending on your needs, there can be advantages to setting up one type of I/O partition instead of another.

“Dynamically switching IOPs between partitions” on page 9

A powerful advantage of logical partitions is ability to dynamically switch an IOP from one partition to another.

“Communication options for logical partitions” on page 29

Learn how logical partitions are able to share data between partitions or between servers.

Logical partition concept: Bus-level and IOP-level I/O partitions:

Depending on your needs, there can be advantages to setting up one type of I/O partition instead of another.

With bus level I/O partitions, the system partitions I/O resources by bus. On a server that is completely partitioned at the bus level, every secondary partition has its own removable media and workstation.

Bus-level logical partitions allow for:

- Better problem isolation and therefore higher availability.
- Better performance.
- Simplified hardware management.

When you partition a server at the IOP level, one or more buses are shared and divided up between the I/O resources by the IOP. This type of logical partitions allows for:

- Greater flexibility when partitioning I/O subsystem.
- Potential cost reduction by eliminating some expansion units which the server requires to support additional buses.
- Optimization of hardware resources to avoid server limits.
- The ability to dynamically move the control of an IOP from one partition to another without the need to restart the system.
- Simplified configuration planning since you can dynamically move hardware from one partition to another.

You might also consider having a system configuration with both bus-level partitioning and IOP-level partitioning. For example, you may put all of the IOPs that you wish to switch in a shared bus and configure all other logical partitions to have bus-level partitioning. The shared bus can then belong to a test partition. This allows you the ability to switch IOPs such as tape drives or LAN adapters to partitions that need these resources.

Related concepts

“Logical partition concept: bus” on page 7

A bus is a conductor that is used for transmitting signals or power.

“Logical partition concept: IOP” on page 10

The IOP attaches to the system I/O bus and one or more input/output adapters (IOAs). The IOP processes instructions from the server and works with the IOAs to control the I/O devices.

“Dynamically switching IOPs between partitions” on page 9

A powerful advantage of logical partitions is ability to dynamically switch an IOP from one partition to another.

“Logical partition concept: IOP and device switching” on page 11

If you elect to partition at the IOP-level, you can switch certain IOPs and all its attached devices between partitions that share the same bus dynamically.

Dynamically switching IOPs between partitions:

A powerful advantage of logical partitions is ability to dynamically switch an IOP from one partition to another.

When you dynamically switch an IOP, you take the control of an IOP away from one partition and give it to another without restarting the server.

On a shared bus, IOPs and their resources (all IOAs and attached devices) can be dynamically moved between partitions. To initiate this action, right click on the desired IOP and select **Move**.

When you dynamically switch an IOP between partitions, you make it appear as though partitions can share devices. For example, if your server has a low use device, more than one partition can use that device by switching IOPs. Each partition can use the device because switching an IOP switches all devices attached to it. However, partitions can only use that device one at a time. You can only switch the IOP to one partition at a time. Before you perform this task, you need to free that device in i5/OS on the source partition. You can do this by using the iSeries Navigator.

IOPs that are candidates for switching include:

- IOPs that control high cost devices.
- IOPs that control low use devices and low demand devices.
- IOPs that solely control the target device or devices.

Before you use IOP switching, you should remember the IBM recommended approach to logical partitioning is to dedicate all hardware within a partition. You should partition your server at the bus level. However, when you use bus level partitioning you cannot switch IOPs. Also, bus level partitioning is not always cost-effective. Therefore, you may find it preferable to share some devices among partitions. And while partitions cannot concurrently share devices, IOP switching may be an effective solution to the cost problem.

Before you implement switching, you should consider other possible alternatives. To share devices among partitions, you can apply the same techniques that are used to share devices among separate physical systems:

- Use multiple IOPs, one in each partition, for devices that support multiple connections (some high end tape drives).
- Use multiple IOPs, one in each partition, and a switch box for devices that only support single connections (printers, or some high end tape drives).
- Use multiple IOPs and multiple devices in each partition for a self-contained solution (internal removable media devices).
- If it is not feasible for you to use any of these alternatives, then you should implement IOP switching.

You can implement dynamic IOP switching by making sure that the primary partition owns each bus with a bus ownership type of *own bus shared*. All secondary partitions can then simply use any bus they need. With this configuration you can assign every IOP in the server to the partition that wants to use it. All partitions can dynamically add and remove any IOPs that control high cost, and low use devices that are attached to the system.

In addition to enabling IOP switching, this configuration has several other advantages.

- Conceptually, the implementation is easy to configure and understand.
- The primary partition will own any new hardware that is added to the system.

- As partition needs change over time, you can make adjustments with optimal hardware use and greater flexibility.

Related concepts

“Logical partition concept: IOP”

The IOP attaches to the system I/O bus and one or more input/output adapters (IOAs). The IOP processes instructions from the server and works with the IOAs to control the I/O devices.

“Logical partition concept: Bus-level and IOP-level I/O partitions” on page 8

Depending on your needs, there can be advantages to setting up one type of I/O partition instead of another.

“Logical partition concept: bus” on page 7

A bus is a conductor that is used for transmitting signals or power.

“Select bus-level or IOP-level partitioning” on page 41

Depending on your needs, there can be advantages to partitioning your I/O resources in different ways.

Logical partition concept: IOP:

The IOP attaches to the system I/O bus and one or more input/output adapters (IOAs). The IOP processes instructions from the server and works with the IOAs to control the I/O devices.

There are many different kinds of IOPs.

- Some IOPs can only support one type of I/O device. In this case the IOA is embedded in the IOP so you can not remove the IOA or change it.
- Some IOPs can support multiple device types, but only one at a time. The type of IOA that is attached determines what device you can use. IOAs on these IOPs can be changed with another IOA to support a different I/O device. The IOA and the IOP work together to control the device.
- Some IOPs can support multiple types of I/O devices at the same time. These are known as Multifunction IOPs (MFIOP) or Combined function IOPs (CFIOP). Multifunction IOPs connect to a variety of different IOAs. For instance, an MFIOP could support disk units, workstations, a communications line, and removable media devices.
- A Combined function IOP can connect to a variety of different IOAs. For instance, a CFIOP could support disk units, a console, and communications hardware. The CFIOP contains some of the same capabilities as an MFIOP, as well as Ethernet and token-ring controllers. IOAs for the supported types of I/O devices attach to the IOP.

There are several important I/O devices in the server. These include the load source disk unit, the alternate IPL device, the system console, and the electronic customer support hardware. The server needs to know where to locate these special devices on secondary partitions. When you create a logical partition, you need to identify the IOPs that control these important devices:

- The IOP that controls the disk unit that will be the load source.
- The IOP that controls the console.
- The IOP that controls the alternate IPL device.
- The IOP that controls the electronic customer support line.

Note: A system with logical partitions needs to have the correct IOP feature codes for the load source disk unit and alternate IPL devices. Without the correct hardware, the secondary partitions will not function correctly.

The system reports all errors that involve IOPs to the product activity log (PAL) in the logical partition that owns the IOP. However, the system may report errors in the PAL of the primary partition against load source IOPs. This may occur when a secondary partition restarts.

Related concepts

“Logical partition concept: bus” on page 7

A bus is a conductor that is used for transmitting signals or power.

“Logical partition concept: Bus-level and IOP-level I/O partitions” on page 8

Depending on your needs, there can be advantages to setting up one type of I/O partition instead of another.

“Dynamically switching IOPs between partitions” on page 9

A powerful advantage of logical partitions is ability to dynamically switch an IOP from one partition to another.

“Logical partition concept: expansion unit” on page 21

You can add an expansion unit to many of the iSeries servers to support additional features and devices.

“Logical partition concept: disk units” on page 16

Disk units store data. The server can use and reuse this data at any time. It is more permanent than memory, but you can still erase it.

“Logical partition concept: alternate restart (IPL) devices and removable media device” on page 17

A removable media device reads and writes to media (tape, CD-ROM, or DVD).

“Logical partition concept: console” on page 21

Each logical partition must have a console attached to it through an IOP.

“Logical partition concept: load source” on page 22

Each logical partition must have one disk unit designated as the load source.

Related tasks

“View the Product Activity Log (PAL) for logical partitions” on page 109

Use Dedicated Service Tools (DST) or System Service Tools (SST) to find system reference codes for logical partitions.

Logical partition concept: IOP and device switching:

If you elect to partition at the IOP-level, you can switch certain IOPs and all its attached devices between partitions that share the same bus dynamically.

The partition that currently owns the IOP must not be in use before you switch the IOP to another partition.

Switching requires removing the IOP from its current partition and adding it to a different one. In other words, two partitions cannot use the IOP and its devices at the same time.

Attention: When switching disk unit IOPs, ensure that all disk units that belong to that specific IOP are first removed from the auxiliary storage pool and are in a non-configured status.

Related concepts

“Logical partition concept: Bus-level and IOP-level I/O partitions” on page 8

Depending on your needs, there can be advantages to setting up one type of I/O partition instead of another.

Logical partition concept: tagged resource:

A tagged resource is an IOP that you select because it controls a device that performs a specific function for a logical partition.

The devices that perform the essential functions are the alternate IPL device, partition console, Electronic Customer Support IOP, and load source resource.

Alternate IPL device

The media in the alternate IPL device is what the system uses to start from when you perform a

D-source IPL. The device can be a tape drive or an optical device. The alternate IPL device loads the Licensed Internal Code contained on the removable media instead of the code on the load source.

Partition console

When using Operations Console, the console and ECS IOP should be the same. The console is the first workstation that the system activates in the partition. The system assumes that this console will always be available for use.

Electronic Customer Support IOP

The Electronic Customer Support IOP is a communications IOP you can select to support Electronic Customer Support on a system or secondary partition. Electronic Customer Support is the part of the operating system that allows you to access the following:

- Question-and-answer (Q and A) function.
- Problem analysis, reporting, and management.
- Fixes (or Program temporary fixes, PTFs).
- IBM product information.
- Technical information exchange.

Load source resource

Each logical partition must have one disk unit designated as the load source. The load source resource is the IOP with the load source. The load source contains the Licensed Internal Code and the configuration data for the logical partitions. The system uses the load source to start the logical partition. The system always identifies this disk unit as unit number 1.

Related concepts

“Logical partition concept: alternate restart (IPL) devices and removable media device” on page 17
A removable media device reads and writes to media (tape, CD-ROM, or DVD).

“Logical partition concept: load source” on page 22

Each logical partition must have one disk unit designated as the load source.

“Logical partition concept: console” on page 21

Each logical partition must have a console attached to it through an IOP.

Logical partition concept: SPD and PCI:

Hardware features are packaged in two different forms: System Product Division (SPD) or Peripheral Component Interface (PCI), depending upon the server model.

SPD I/O adapters (IOAs) are packaged with I/O processors (IOPs) and do not require a separate card position. The device connects to the slot containing the IOA and the IOP.

PCI IOAs are packaged separately from the IOP and require a separate card slot. The IOP in a card position is connected to the IOA in another card slot. The device attaches to the IOA.

Logical partition concept: Processor:

A processor is a device that executes programmed instructions.

Logical partitions support dedicated processors and shared processors. The more processors you have the greater number of concurrent operations being executed at any given time. Your processor sends and receives information from the different parts of the system (from hardware and software).

Processors can work as a group to decrease the computing time that an operation requires. The fewer the number of processors in a system the longer the amount of computing time needed. If more processors are allocated to a partition, the greater the number of concurrent operations.

You measure the total system performance in the Commercial Processing Workload (CPW) that is unique for each model. The relative performance of a partition equals the CPW for the entire system times the number of processors in a logical partition divided by the total number of processors on the system.

Relative logical partition performance = (CPW) (# processors in the logical partition/total # of processors).

From the Configure Logical Partition window, you can view all of the system processor hardware resources. From the primary partition, you can also see which processors the logical partitions own.

If a processor fails while the server is running, then all the logical partitions on that server (not just the one with the faulty processor) fail. If a processor failure is detected during the system restart (IPL), the logical partition configuration manager will attempt to honor the minimum processor setting for all partitions. Once minimums have been met, all remaining resources are distributed, proportional to the intended allocation, among the appropriate partitions. If the partition minimums cannot be met, all resources are left in the primary partition and no secondary partitions are started. An entry is placed in the primary partition Product Activity Log (PAL) with a System Reference Code (SRC) of B6005342 to indicate that the minimum configuration could not be met. The primary partition PAL also contains one or more entries to indicate the failing hardware. You can view processor errors in the Product Activity Log (PAL) on the primary partition.

Related concepts

“Logical partition concept: memory” on page 15
Processors use memory to temporarily hold information.

Related tasks

“View the Product Activity Log (PAL) for logical partitions” on page 109
Use Dedicated Service Tools (DST) or System Service Tools (SST) to find system reference codes for logical partitions.

Logical partition concept: dedicated processor:

Dedicated processors are whole processors that are used exclusively by the partition to which they are assigned. The dedicated processor handles the processing for a specific logical partition.

If you choose to assign dedicated processors to a logical partition, you must assign at least one processor to that partition. Likewise, if you choose to remove processor resources from a dedicated partition, you must remove at least one processor from the partition.

To adjust to changing workloads, you can move dedicated processors within the minimum/maximum values you establish without needing to restart the partition. These values enable you to establish a range within which you can dynamically move the resource without needing to restart the logical partition. When you change the minimum/maximum values, it requires you to restart the partition. Minimum values dictate what is required to restart the partition. If the minimum value is not met for all logical partitions, only the primary will restart.

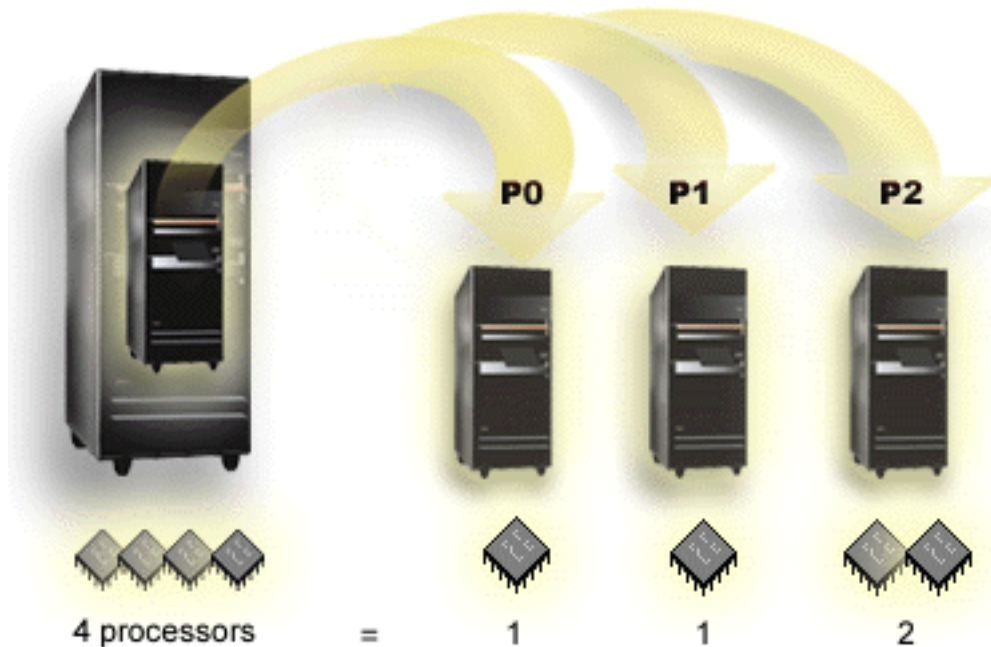

For example, a server with 4 physical processors can have 3 logical partitions with two partitions having 1 dedicated processor and one partition having 2 dedicated processors.

Related concepts

“Determine the possible number of logical partitions” on page 41

The number of processors you want to add to a logical partition depends on the planned workload for the partition and the desired level of performance.

Related tasks

“Hardware for logical partitions” on page 5

Understand the basic hardware concepts and requirements to partition your server.

Logical partition concept: shared processor pool:

The shared processing pool allows you to assign partial processors to a logical partition.

The physical processors are held in the shared processing pool and are shared among the logical partitions. A minimum of 0.10 processing units can be configured for any partition using shared processors. The primary partition may require more than 0.10 processing units when starting secondary partitions, otherwise timeout conditions may occur with resources communicating directly with the primary partition. Each system processing capacity and partition configuration needs to be evaluated to determine reasonable processor units for primary and secondary partitions.

Virtual processors are the whole number of concurrent operations which the operating system can utilize. The processing power can be conceptualized as being spread equally across these virtual processors. Selecting the optimal number of virtual processors is dependent on the workload in the partition: some benefit from greater concurrence, others require greater power. It is recommended to keep a balance of virtual processors to processors units. If less than or equal to 1.00 processing units are specified, 1 virtual processor should be used. Likewise, if less than or equal to 2.00 processing units are specified, 2 virtual processors should be used. If an imbalance of processing units and virtual processors occurs, partition batch performance may be degraded.

To accommodate changing workloads, you can adjust shared processing units within the minimum/maximum values you establish without needing to restart the partition. These values enable you to establish a range within which you can dynamically move resources without needing to restart the logical partition. When you change the minimum/maximum values, you must restart the partition. Minimum values dictate what is required to restart the partition. If the minimum value is not met for all logical partitions, only the primary will restart.

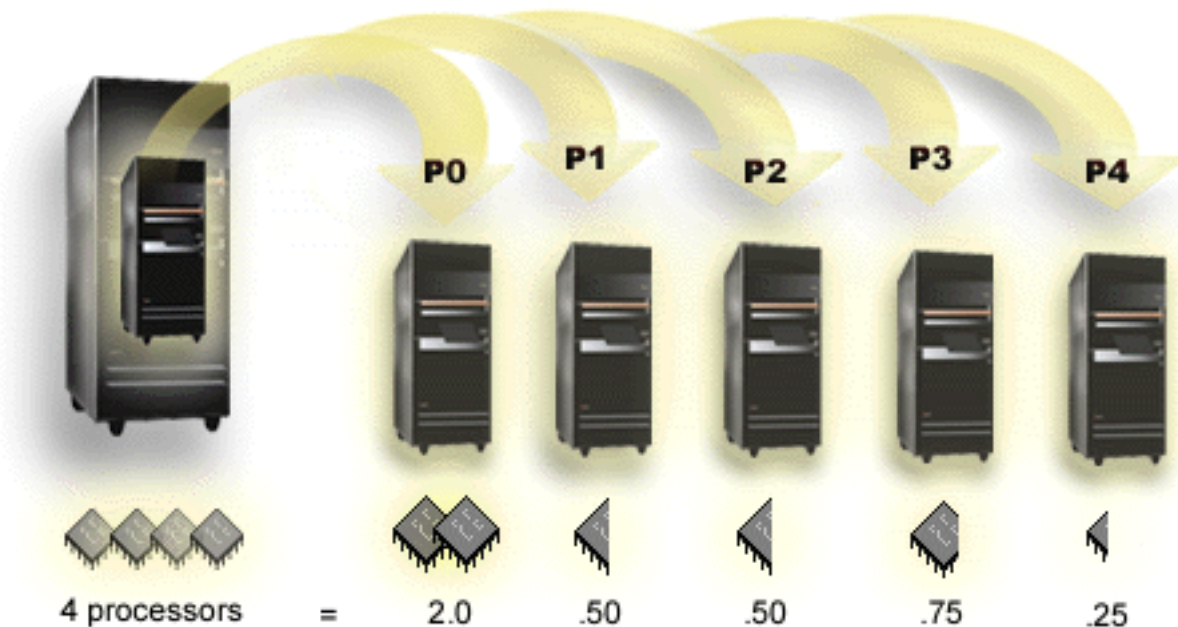

For example, a system with 4 processors in the shared pool provides 4.00 processing units. Five logical partitions could distribute the processing power in the following way: Partition 0 has 2.00 processing units and 2 virtual processors, partition 1 has 0.50 processing units and 1 virtual processor, partition 2 has 0.50 processing units and 1 virtual processor, partition 3 has 0.75 processing units and 1 virtual processor, and partition 4 has 0.25 processing units and 1 virtual processor. The sum of the 5 logical partition's processing units is less than or equal to the total number of processing units in the shared pool. But the total number of virtual processors is 6.

Related concepts

“Determine the possible number of logical partitions” on page 41

The number of processors you want to add to a logical partition depends on the planned workload for the partition and the desired level of performance.

Related tasks

“Hardware for logical partitions” on page 5

Understand the basic hardware concepts and requirements to partition your server.

Logical partition concept: memory:

Processors use memory to temporarily hold information.

Memory requirements for partitions are dependent on partition configuration, I/O resources assigned, and applications used. When you create a partition, you must add a whole number of megabytes of memory to it (1 MB = 1024 x 1024 bytes). The primary partition needs a minimum of 256 MB of memory. Depending on configuration values used, a primary partition may require more than 256 MB. Secondary

partitions running V4R4 and V4R5 require a minimum value of 64MB. Secondary partitions running V5R1 and V5R2 require a minimum of 128 MB of memory. Depending on configuration values used, a secondary partition may require more than 128 MB.

Memory in each logical partition operates within its assigned minimum and maximum values. You can dynamically move memory between V5R1 and V5R2 logical partitions without needing to restart the affected partitions as long as your request for memory movement is within the range of the minimum and maximum values specified during partition creation. When you request to dynamically move memory between partitions, note that this memory is removed and added to the base memory pool of each of the partitions (*BASE pool). Private memory pools or shared memory pools are not affected. If the move request exceeds the amount of memory available in the base pool, the system will only free up excess memory pages after keeping the minimum amount of memory required in the base pool. This value is determined by the base storage minimum size (QBASPOOL) system value. To prevent any data loss during memory movement, the system first writes any data from memory pages to the disks before making the memory pages available to another partition. Depending on the amount of memory you have requested to move, this may take some time.

Each partition will report its runtime minimum memory size. This value is an estimate of how much memory in the partition is locked into that partition and cannot be moved dynamically. Reducing the number of processes or threads within a partition or changing the *BASE pool will affect the runtime minimum.

The full amount of memory that you assign to a logical partition may not be available for the partition's use. Static memory overhead required to support the assigned maximum memory will affect the reserved or hidden memory amount. This static memory overhead will also influence the minimum memory size of a partition.

The minimum memory size assigned to a partition can be changed with only a restart of the partition. However, changes to the maximum memory size require a restart of the entire system and may require a larger minimum memory value.

If there is a memory failure, the system will attempt to accommodate the minimums for all partitions. If all minimums are satisfied, the secondary partitions will restart with all additional resources distributed proportionally to their allocation. If all minimums are not satisfied, the system will put all resources in the primary and fail to restart with the partition configuration protected and a product activity log (PAL) error of B6005343. You can view memory errors in the PAL on the primary partition.

Related concepts

“Logical partition concept: bus” on page 7

A bus is a conductor that is used for transmitting signals or power.

“Logical partition concept: Processor” on page 12

A processor is a device that executes programmed instructions.

“Restart and power down a system with logical partitions” on page 84

Understand how to safely restart and power down a system with logical partitions.

Related tasks

“View the Product Activity Log (PAL) for logical partitions” on page 109

Use Dedicated Service Tools (DST) or System Service Tools (SST) to find system reference codes for logical partitions.

Logical partition concept: disk units:

Disk units store data. The server can use and reuse this data at any time. It is more permanent than memory, but you can still erase it.

You cannot separate the disk units on an IOP into different logical partitions. You can create user auxiliary storage pools (ASPs) on any logical partition. However, you cannot create a cross-partition ASP. All of the disk units you assign to an ASP must be from the same logical partition.

You can also create an independent auxiliary storage pool (ASP). An independent ASP is a collection of disk units that can be taken offline, or made unavailable, independent of other disk pools because the data in the independent ASP is self-contained. The independent ASP can also be brought online, or made available, while the system is active, without having to perform a restart.

The server maintains the logical partition configuration data on the disk unit that you designate as the load source for each logical partition.

When you move disk units, you may need to clear any logical partition configuration data that is contained on them.

Related concepts

“Logical partition concept: load source” on page 22

Each logical partition must have one disk unit designated as the load source.

“Logical partition concept: IOP” on page 10

The IOP attaches to the system I/O bus and one or more input/output adapters (IOAs). The IOP processes instructions from the server and works with the IOAs to control the I/O devices.

Disk pools

Using independent disk pools

Related tasks

“Clear partition configuration data from nonconfigured disk units” on page 131

When you move disk units among logical partitions or servers, you may need to erase any old configuration data before the server can use the logical partition again.

Logical partition concept: alternate restart (IPL) devices and removable media device:

A removable media device reads and writes to media (tape, CD-ROM, or DVD).

You must have either a tape or an optical (CD-ROM or DVD) device available for every logical partition. The system also uses some of these devices as the alternate restart or IPL device and alternate installation device.

Logical partitions can (depending on your hardware setup) share a tape or optical device and its attaching IOP among themselves. However, only one logical partition can use the device at any time. To switch devices between partitions, you must move the IOP, with the shared device, to the desired logical partition. For more information on how to move an IOP, refer to Logical Partition concept IOP.

Alternate IPL Device

The media in the device is what the system uses to start from when you perform a D source IPL. The alternate IPL device loads the Licensed Internal Code contained on the removable media instead of the code on the load source. It may also install the system.

Related concepts

“Logical partition concept: tagged resource” on page 11

A tagged resource is an IOP that you select because it controls a device that performs a specific function for a logical partition.

“Logical partition concept: IOP” on page 10

The IOP attaches to the system I/O bus and one or more input/output adapters (IOAs). The IOP processes instructions from the server and works with the IOAs to control the I/O devices.

“Logical partition concept: load source” on page 22
Each logical partition must have one disk unit designated as the load source.

Related tasks

“Hardware for logical partitions” on page 5
Understand the basic hardware concepts and requirements to partition your server.

Logical partition requirements for alternate IPL devices:

After partitions are defined, the Licensed Internal Code and operating system must be loaded from either optical or tape to the load source disk unit for the logical partition.

During partition setup, you must select which I/O processor (IOP) connects to the alternate Initial Program Load (IPL) device (either tape device or optical device).

An IBM external tape device, or equivalent, that is attached to an IOA that supports alternate IPL, and can be attached to a system on which you can create partitions, can be used as a alternate IPL device. There is no support for external CD-ROM devices on 6xx, 7xx, Sxx systems. For 8xx servers, you can attach a 7210 external CD-ROM to a 2768.

Note: When attaching an external CD-ROM as an alternate IPL device, it must be at hardware Unit Address 5, Unit Address 6, or Unit Address 7. The following table shows the translation from SCSI to hardware Unit Addresses.

Table 1. SCSI to Unit Address conversion

SCSI Address	Unit Address
2	5
1	6
0	7

IOP considerations

IOP considerations are as follows:

- If you want to support both optical and tape devices with a single SPD IOP, it must be a 2624, which supports only 6380 and 6390 internal tape devices.
- The 2624 IOP does not support optical or tape devices in the SPD Integrated Expansion Unit 9364 and 9331 (servers 620 and 720), or 5064 and 9331 (servers S20 and 720).
- Only servers 650, 740, S40 support switching internal primary partition alternate IPL devices (optical devices and tape devices) to secondary partitions.

The following are requirements for alternate IPL devices:

- Rules for an alternate IPL IOP on a secondary partition
- Rules for an internal alternate IPL device on a secondary partition
- Other rules relating to the alternate IPL device

The LPAR Validation Tool (LVT) , as well as the System Handbook, show the internal tape alternate IPL devices that are supported by logical partitions based on the server ordered.

The following table shows the internal CD-ROM alternate IPL devices that are supported by logical partitions.

Table 2. Supported internal CD-ROM devices

Internal optical device feature code	810, 820, 825, 870, 890	830/840 5065/5066 5074/5079	620/720/S20	All Other Systems
6325				X
6425			X	
6005		X		
4525	X			

Rules for secondary partition alternate IPL IOP

Hardware requirements allow only certain IOPs to be used as the alternate IPL IOP in a secondary partition. Some of these IOPs must be in specific card positions in their expansions units. The IOP, specified during partition setup, must be one of the following:

Table 3. Placement for a SPD alternate IPL IOP

SPD IOPs	Description	5072/5073 card position	5064/9364 card position
2621	Removable media device attach	any	any
2624	Storage device controller	3	S02
2644	34xx Magnetic Tape Attachment	any	any
6501	Tape or disk device controller	any	any
6513	Internal tape device controller	3	S02
6534	Magnetic media controller	any	any

Table 4. Placement for a PCI alternate IPL IOP in 5064/9364, 5065/5066

PCI IOP	Description			
2809, 2824	PCI WAN/LAN workstation IOP Note: Even though its description does not say so, 2809 or 2824 also supports CD-ROM and tape with one of the following I/O adapters (IOAs):			
	PCI IOA	Description	5064/9364 IOP/IOA card positions	5065/5066 IOP/IOA card positions
	2726, 2768	PCI RAID Disk Unit Controller	E15/E16	N/A
	2729	PCI Magnetic Media Controller	E10/E11 or E05/E06	C3/C4 ¹ or C8/C9 ¹ or C13/C14 ¹
	2741	PCI RAID Disk Unit Controller	E15/E16	N/A
	2748	PCI RAID Disk Unit Controller	E15/E16	C3/C4 ²
Notes:				
1. External tape attach only				
2. CD-ROM or internal tape attach only				

Table 5. Placement for a PCI alternate IPL IOP in 8xx, 5074, 5075, 5079

PCI IOP	Description	
2843, 2844, 284C, 284B, 9943	PCI WAN/LAN Workstation IOP Note: 284C is only supported on server 820. 284B is only supported in the 5075. All other servers and expansion units can use either the 2843, 2844, or 9943.	
	PCI IOA	8xx, 5074, 5075, 5079 card positions
	2749	Any IOA slot
	2757	Any IOA slot
	2768	Any IOA slot
	2778	Any IOA slot
	2782	Any IOA slot
	4748	Any IOA slot
	4778	Any IOA slot
	5702	Any IOA slot
	5703	Any IOA slot

Rules for secondary partition internal alternate IPL devices

The alternate IPL device is in the same expansion unit as its controlling IOP. It must be placed as follows:

Table 6. Placement for an internal alternate IPL device

Expansion unit	Removable media slot
5072, 5073, 5077	D01, D02, or D03
5064/9364, 5034, 5035	D12 or D13 ¹
5065, 5066, 5074, 5079	D41 or D42
9251	D03 or D04 ²
Notes:	
1. Models 620/720/S20 only	
2. Models 650/740/S40 only	

Internal removable media devices are:

- Quarter-inch cartridge (QIC) 1/4-Inch tape
- 8 mm tape
- CD-ROM

Other rules for secondary partition alternate IPL

- The alternate IPL device must be connected to SCSI bus 0.
- The alternate IPL IOP is specified during partition setup.
- If the alternate IPL IOP is attached to 2624 (SPD), the following applies:
 - QIC 1/4-inch tape must be 6380 or 6390
 - 2624 does not support tape or CD-ROM in SPD expansion unit 5064/9364 (models 620/720/S20).
- CD-ROM devices are not supported on 6513 (SPD)
- 2726, 2741, 2757, 2782, 5702, and 5703 also support disk devices. These IOAs should not be used to attach removable media that will be switched between partitions if disk devices are also attached.

Information about all supported internal tape and CD-ROM features and the IOPs to which they must be attached can be found in the LVT, and in the System Handbook.

Logical partition concept: console:

Each logical partition must have a console attached to it through an IOP.

Each logical partition must have a console attached to it through an IOP. The console is the first workstation that the system activates. The system assumes that this console will always be available for use. You can access the dedicated service tools (DST) display only from this console.

A secondary partition console can be a twinaxial workstation, a local console on a network or a local console directly attached to the server.

Attention: If you plan on using Operations Console local console on a network and you have a twinax IOA on the same IOP, it is possible the twinax workstation may come up first and become the console. Possible solutions would be to have the twinax IOA on a different IOP, to configure the terminal at a different address other than 0, or to unplug the device from the twinax cable.

For an Operations Console local console directly attached to the server configuration, the console IOP needs to be marked as both the console and electronic customer support (ECS) IOP.

For any other type of console, including Operations Console local console on a network configuration, Operations Console uses a token ring or Ethernet communication card, simply show the preferred type of IOP and select the desired one on the New Logical Partition - Console panel.

Related concepts

“Logical partition concept: tagged resource” on page 11

A tagged resource is an IOP that you select because it controls a device that performs a specific function for a logical partition.

“Logical partition concept: IOP” on page 10

The IOP attaches to the system I/O bus and one or more input/output adapters (IOAs). The IOP processes instructions from the server and works with the IOAs to control the I/O devices.

Related tasks

“Hardware for logical partitions” on page 5

Understand the basic hardware concepts and requirements to partition your server.

Logical partition concept: expansion unit:

You can add an expansion unit to many of the iSeries servers to support additional features and devices.

If you want to create logical partitions on your iSeries server, you will probably need to add an expansion unit. This will contain the additional hardware that you need for each logical partition.

There are different types of expansion units. Some expansion units can support only disk units (storage expansion unit), while others can support a variety of hardware (system expansion unit). This is dependent on the kind of buses and IOPs that are installed in the unit.

Expansion units generally contain one or two system I/O bus with multiple IOPs that control various I/O devices.

Related concepts

“Logical partition concept: bus” on page 7

A bus is a conductor that is used for transmitting signals or power.

“Logical partition concept: IOP” on page 10

The IOP attaches to the system I/O bus and one or more input/output adapters (IOAs). The IOP processes instructions from the server and works with the IOAs to control the I/O devices.

Related tasks

“Hardware for logical partitions” on page 5

Understand the basic hardware concepts and requirements to partition your server.

Logical partition concept: load source:

Each logical partition must have one disk unit designated as the load source.

The load source contains the Licensed Internal Code and the configuration data for the logical partitions. The server uses the load source to start the logical partition. The server always identifies this disk unit as unit number 1.

The logical partition configuration data on the load source of the primary partition is the master copy. The server uses this copy to check the integrity of the configuration data that it maintains on the load source of each logical partition.

Any time the load source of a logical partition is erased, the logical partition configuration data must be recovered. On a secondary partition, the server automatically rewrites the data by using the master copy from the primary partition. On the primary partition, you must manually recover the configuration data.

When you move the load source for a logical partition to a different server or different logical partition as a nonconfigured disk unit, you need to clear its configuration data. This recovery action corrects configuration data problems.

Related concepts

“Logical partition concept: tagged resource” on page 11

A tagged resource is an IOP that you select because it controls a device that performs a specific function for a logical partition.

“Logical partition concept: disk units” on page 16

Disk units store data. The server can use and reuse this data at any time. It is more permanent than memory, but you can still erase it.

“Logical partition concept: alternate restart (IPL) devices and removable media device” on page 17

A removable media device reads and writes to media (tape, CD-ROM, or DVD).

“Logical partition concept: IOP” on page 10

The IOP attaches to the system I/O bus and one or more input/output adapters (IOAs). The IOP processes instructions from the server and works with the IOAs to control the I/O devices.

Related tasks

“Recover logical partition configuration data” on page 127

You can use this option to recover logical partition configuration data if one of your secondary partitions is running the i5/OS operating system. This procedure is part of a full server recovery.

“Clear partition configuration data from nonconfigured disk units” on page 131

When you move disk units among logical partitions or servers, you may need to erase any old configuration data before the server can use the logical partition again.

Load source placement rules for secondary partitions:

Each logical partition requires a load source disk unit.

The load source contains the Licensed Internal Code. The server uses the load source to start the partition. Each secondary partition has a specific slot placement for its load source depending on the type of system unit or expansion unit where it is installed. An IOP and IOA is then required to control the load source disk unit for each partition.

Attention: The information provided does not replace the LPAR Validation Tool. This information should be used as a resource with the LVT output. It's purpose is to assist you in the load source placement for your secondary partitions.

The load source disk for a secondary partition must be placed as follows:

Server or Expansion Unit	IOA	Disk Slot
5082 or 5083		15C
5064 or 9364		F31, F32, F33, F34
5052 or 5058		K01, K02, K03, K04
5077	617A in S02 and S03	11A, 11B, 13A, 13B
5065 or 5066	IOA in slot C4	D31, D32, D33, D34
	IOA in slot C9	D01, D02
	IOA in slot C14	D06, D07
5074 or 5079	The IOA controlling DB3	D31, D32, D33, D34
	The IOA controlling DB1	D01, D02
	The IOA controlling DB2	D06, D07
5094 or 5294	SCSI Bus Port 0 of any storage IOA to which a load source disk unit is connected.	D01, D02, D11, D12, D21, D22, D06, D16, D17, D26, D27, D31, D32, D33, D34
5075		D01, D02, D03, D04
5095	The IOA controlling DB1	D01, D02, D03, D04
	The IOA controlling DB2	D07, D08, D09, D10
800/810	The IOA controlling DB2	D09, D10, D11, D12
	The IOA controlling DB3	D15, D16, D17, D18
820	The IOA controlling DB2	D07, D08, D09, D10
825	The IOA controlling DB3	D06, D07, D08, D09
	The IOA controlling DB4	D11, D12, D13, D14
830, 840, 870, or 890	The IOA controlling DB1	D01, D02
	The IOA controlling DB2	D06, D07

You should be aware of these rules for secondary partition load source placement:

- You specify the load source IOP when you create your partition.
- Disk compression must be disabled for the load source disk.
- Disk units must have at least 1GB of usable capacity.
- **Attention:** A parity-protected 1GB file (6602 or 6605) cannot be used.
- Disk mirroring requires two load source disk devices in valid load source positions.
- External disk units can not be used.
- Any disk IOP or IOAs that can attach to a system capable of having logical partitions can be used for additional storage capacity once the special requirements for load source disk are met.
- Each partition has its own single level storage and hence its own ASP configuration. The same rules for ASP configuration apply within a partition as apply on a system without logical partitions.
- Disk protection can be defined for a partition in the same way as for a non-partitioned system: parity protection (RAID), mirroring, or mixed. Bus-level mirroring requires two buses in the partition. IOP-level partitioning requires two disk IOPs in the partition.

- Disk units that are already in use by a logical partition can not be added to a different logical partition. You must first remove them from the configuration of the partition that is using the disk units before adding the disk units to a different partition. In doing this, the system automatically moves any user or system data to other disk units in the same ASP.
- For a 5094 or 5294, you can attach load source disk units to a maximum of 9 storage IOAs. Also, a 5094 or 5294 can have load source disk units for up to six secondary partitions.

Software licensing and licensed programs for logical partitions

Learn about the software licensing and pricing strategy for IBM products on an iSeries server with logical partitions.

Unique software resources exist and operate on hardware that is assigned to each partition. These software resources include separate copies of Licensed Internal Code, i5/OS , and other licensed program products. Additionally, language feature codes, security, user data, most system values, and software release and fixes (or program temporary fixes, PTFs) remain unique for each logical partition.

Software license behavior varies by software product. Each solution provider has its own licensing strategy. You can use IBM software products, licensed by the processor group, in any partition. All you need to do is purchase one license for the iSeries server. You can then install the product on any partition you choose. IBM user-based products are priced based on the total number of users running across all partitions of an iSeries server

Software licensing and pricing for IBM software products on servers running multiple partitions remains largely unchanged from current licensing and pricing policies. Processor-based products running in an environment with logical partitions are priced according to the Software Machine Group of the underlying iSeries hardware model. Processor-based one time charge IBM software products are licensed to run simultaneously in all of the partitions on the server. IBM user-based products are priced based on the total number of users running across all partitions of an iSeries.

Software license management functions that currently exist in i5/OS are available in an environment with logical partitions. Software license management supports the various pricing models that iSeries Independent Software Vendors typically use to license their products on an iSeries server.

Software license management has 3 usage types: registered users, concurrent users and processors. All three count usage across the server. It can determine and enforce the number of users for a licensed product across multiple logical partitions of an iSeries.

Shared processor pool considerations for i5/OS license agreements:

Unique software resources exist and operate on hardware that is assigned to each partition.

These software resources include separate copies of Licensed Internal Code, i5/OS, and other licensed program products. Additionally, language feature codes, security, user data, most system values, and software release and fixes (or program temporary fixes, PTFs) remain unique for each logical partition.

If you use the shared processing pool, you should be aware of the maximum number of virtual processors you allocate to each partition on your server. Depending on your logical partition configuration, you might need to purchase more i5/OS licenses to ensure compliance with your i5/OS license agreement. IBM rounds up to the nearest whole number in calculating the number of software licenses you need to purchase. However, IBM never charges you for more software licenses than the number of physical processors that exist on your server.

For example, Company Y has purchased 2 i5/OS licenses. Company Y has a server with 3 processors and 4 logical partitions. All 4 partitions use the shared processing pool. The configuration of the partitions is as follows:

Table 7. Logical partition configuration in compliance with license agreement

Partition name	Operating system	Processing units used by each partition	Total processing units
Partition A	i5/OS	0.25	2.0
Partition B	i5/OS	1.75	
Partition C	Linux	0.25	1.0
Partition D	Linux	0.75	

The configuration in the previous table is in compliance with Company Y's license agreement because only a total of 2 processing units in the shared processing pool are being used by i5/OS partitions. However, Company Y can easily become out of compliance with their i5/OS license agreement with this configuration.

For instance, the system administrator powers off Partition C and moves its processing units to Partition A. The total processing units being used by the i5/OS partitions increase to 2.25 units. The following table shows the new partition configuration.

Table 8. Logical partition configuration not in compliance with license agreement

Partition name	Operating system	Processing units used by each partition	Total processing units
Partition A	i5/OS	0.50	2.25
Partition B	i5/OS	1.75	
Partition C (powered off)	Linux	0.00	0.75
Partition D	Linux	0.75	

When determining the total number of i5/OS licenses required, any partial processing units used by i5/OS are rounded up to the next whole number in the final count. Therefore, if Company Y uses the configuration in the previous table, they need three i5/OS licenses. Because Company Y has only purchased two i5/OS licenses, they are out of compliance with their license agreement. To ensure that they are in compliance with their license agreement, Company Y must either decrease the maximum number of processing units that Partition A uses or purchase another i5/OS license.

You must have enough i5/OS licenses to equal the maximum processor capacity of your partitions. If your processor capacity exceeds the number of i5/OS licenses you have purchased, you will receive out of compliance messages. To stop receiving these messages, you can contact IBM to purchase more licenses or you can reconfigure your processor allocation.

Logical partition release support:

Systems with logical partitions have the capability to support more than one version of OS/400® or i5/OS.

The logical partition strategy is to support up to four different releases on the same system, provided that all releases are supported on the server model. The releases that you can install on a particular server depend upon which releases are supported on the server model and upon which release you choose to install on the primary partition (which will be denoted in this article as the reference release, or P).

If the primary partition is running Version 4 Release 5 (V4R5) or earlier, you can install and run the following releases on the secondary partitions, provided that each release is supported by the server model:

- The release before the release on the primary partition (P - 1)

- The release on the primary partition (P)
- The release after the release on the primary partition (P + 1)

The only exception to this rule is when the primary partition of 6xx, 7xx, or Sx0 servers runs V4R4. In this case, you can install V5R1 on a secondary partition of those servers.

For example, if V4R5 is running on the primary partition of a server, you can install V4R4, V4R5, or V5R1 on the secondary partitions, provided that the server supports those releases.

If the primary partition is running V5R1 or later, you can install and run the following releases on the secondary partitions, provided that each release is supported by the server model:

- The release before the release on the primary partition (P - 1)
- The release on the primary partition (P)
- The release after the release on the primary partition (P + 1)
- The second release after the release on the primary partition (P + 2)

For example, if V5R1 is running on the primary partition of a server, you can install V4R5, V5R1, V5R2, or V5R3 on the secondary partitions, provided that the server supports those releases.

The logical partition functionality that will be supported on your server depends upon the server model and upon the releases of OS/400 and i5/OS that you have installed on the server. For more information on the logical partition functionality supported on each server model, see Evaluate the hardware limitations of the iSeries(TM) servers. For more information on the logical partition functionality supported by each release, see OS/400 and i5/OS logical partition function by release.

Related concepts

“Software requirements for logical partitions” on page 52

Learn what release levels are supported and how you can partition your system to support new functions.

“Perform dynamic movement of resources” on page 43

You can dynamically move processors, memory, and interactive performance.

“Evaluate the hardware limitations of the iSeries servers” on page 46

The 6xx, 7xx, Sxx, 8xx, and 890 n-way base servers support logical partitions (LPAR).

OS/400 and i5/OS release support for the 6xx, 7xx, and Sx0 models: The 6xx and Sx0 servers support all releases from V4R4 through V5R2. The 7xx servers support all releases from V4R4 through V5R3. These models do not support the shared processor pool. Because of this, you can partition these models only if the server has two or more processors.

Primary	Secondary (P-1)	Secondary (P)	Secondary (P+1)	Secondary (P+2)
V4R4	not supported	V4R4	V4R5	V5R1
V4R5	V4R4	V4R5	V5R1	not supported
V5R1	V4R5	V5R1	V5R2	not supported
V5R2	V5R1	V5R2	V5R3 (7xx hardware only)	not supported
V5R3 (7xx hardware only)	V5R2	V5R3	not supported	not supported

OS/400 and i5/OS release support for the 820, 830, 840, and 270 models: The 8xx hardware (excluding the 810, 825, 870, and 890 models) can support release V4R5 or later in a primary or secondary partition as long as the 8xx model has more than one processor. The 270 hardware can only support V4R5 in a secondary partition on the 2-way processor configuration. The 270 and 8xx models (excluding the 810, 825, 870, and 890 models) with a single processor can support V5R1 or later releases in all partitions.

Primary	Secondary (P-1)	Secondary (P)	Secondary (P+1)	Secondary (P+2)
V4R5	not supported	V4R5	V5R1	not supported
V5R1	V4R5	V5R1	V5R2	V5R3
V5R2	V5R1	V5R2	V5R3	V5R4
V5R3	V5R2	V5R3	V5R4	future release supported
V5R4	V5R3	V5R4	future release supported	future release supported

Attention: Some 820, 830, and 840 models only support V5R1 or later in the primary partition. Consult your IBM Business Partner, marketing representative, or service specialist for more details.

OS/400 and i5/OS release support for the 810, 825, 870, and 890 models: The 810, 825, 870, and 890 hardware can support V5R2 and later in all partitions.

Primary	Secondary (P-1)	Secondary (P)	Secondary (P+1)	Secondary (P+2)
V5R2	not supported	V5R2	V5R3	V5R4
V5R3	V5R2	V5R3	V5R4	future release supported
V5R4	V5R3	V5R4	future release supported	future release supported

i5/OS logical partition function by release:

The capabilities available in i5/OS logical partitions vary with each operating system release.

When you install multiple releases on a single server, the release on the primary partition determines the base logical partitioning functionality available on that server. For example, if you install V4R5 on the primary partition of a server, you are not able to use shared processors on that server, because V4R5 does not support shared processors. This is the case even if shared processors are supported on that server model and you install V5R1 (which supports shared processors) on multiple secondary partitions.

Also, installing an earlier release on a secondary partition limits the logical partitioning functionality available to that secondary partition. For example, if you install V4R5 on a secondary partition, the secondary partition is not able to use shared processors. This is the case even if you have installed V5R1 on the primary partition and on other secondary partitions. (The primary partition and the secondary partitions on which you have installed V5R1 can still use shared processors, even if you have installed V4R5 on another secondary partition.)

Use the following table to determine the logical partition function by release.

Software Function	V4R4	V4R5	V5R1 and V5R2	V5R3 and later
Maximum Partitions	12 or the number of processors on the system, whichever is less.	12 for 6xx, 7xx, Sx0 models; 24 for 820, 830, and 840 models; or the number of processors on the system, whichever is less.	12 for 6xx, 7xx, Sx0 models; 32 for 270, 810, 820, 825, 830, 840, 870, and 890 models. (The maximum number of partitions supported depends on the number of processors in the server model. 810, 825, 870, and 890 models only support V5R2 or later.)	12 for 7xx models. 32 for 810, 820, 825, 830, 840, 870, and 890 models. (The maximum number of partitions supported depends on the number of processors in the server model.)
Processors	<ul style="list-style-type: none"> • Static: requires a restart of the partition to change. • Dedicated to a partition. 	<ul style="list-style-type: none"> • Static: requires a restart of the partition to change. • Dedicated to a partition. 	<ul style="list-style-type: none"> • Dynamic: can be changed with a restart of the partition. • Can be shared among multiple partitions. 	<ul style="list-style-type: none"> • Dynamic: can be changed with a restart of the partition. • Can be shared among multiple partitions.
Memory	Static: requires a restart of the partition to change.	Static: requires a restart of the partition to change.	Dynamic: can be changed without a restart of the partition.	Dynamic: can be changed without a restart of the partition.
Interactive	Static: requires a restart of the partition to change.	Static: requires a restart of the partition to change.	Dynamic: can be changed without a restart of the partition.	Dynamic: can be changed without a restart of the partition.
Virtual OptiConnect	<ul style="list-style-type: none"> • Static: requires a restart of the entire system to change. • Single network. 	<ul style="list-style-type: none"> • Static: requires a restart of the entire system to change. • Single network. 	<ul style="list-style-type: none"> • Dynamic: can be changed without a restart of the partition. • Single network. 	<ul style="list-style-type: none"> • Dynamic: can be changed without a restart of the partition. • Single network.
Virtual Ethernet	Not supported.	Not supported.	<ul style="list-style-type: none"> • Dynamic: can be changed without a restart of the partition. • Up to 16 networks. 	<ul style="list-style-type: none"> • Dynamic: can be changed without a restart of the partition. • Up to 16 networks.
HSL OptiConnect	Not supported.	Not supported.	<ul style="list-style-type: none"> • Dynamic: can be changed without a restart of the partition. • Can be shared among multiple partitions. • Single network. 	<ul style="list-style-type: none"> • Dynamic: can be changed without a restart of the partition. • Can be shared among multiple partitions. • Single network.

Software Function	V4R4	V4R5	V5R1 and V5R2	V5R3 and later
I/O	<ul style="list-style-type: none"> Allocated at bus-level or IOP-level. IOP can be switched among partitions dynamically. Bus ownership or bus usage (shared or dedicated) changes require a restart of the whole system. 	<ul style="list-style-type: none"> Allocated at bus-level or IOP-level. IOP can be switched among partitions dynamically. Bus ownership or bus usage (shared or dedicated) changes require a restart of the whole system. 	<ul style="list-style-type: none"> Allocated at bus-level or IOP-level. IOP can be switched among partitions dynamically. Bus ownership or bus usage (shared or dedicated) changes occur dynamically. 	<ul style="list-style-type: none"> Allocated at bus-level or IOP-level. IOP can be switched among partitions dynamically. Bus ownership or bus usage (shared or dedicated) changes occur dynamically.
Guest Partition	Not supported.	Not supported.	Linux.	Linux.

When you have determined the software capabilities, ensure that the particular hardware model supports all of the required logical partition capabilities. Additional details are located in Evaluate the hardware limitation of the iSeries.

Related concepts

“Evaluate the hardware limitations of the iSeries servers” on page 46

The 6xx, 7xx, Sxx, 8xx, and 890 n-way base servers support logical partitions (LPAR).

Communication options for logical partitions

Learn how logical partitions are able to share data between partitions or between servers.

Logical partitions can use any of the following communication methods to interact with other partitions or servers.

Related concepts

“Logical partition concept: bus” on page 7

A bus is a conductor that is used for transmitting signals or power.

“Networking for logical partitions” on page 47

Logical partitions can use any of several communication methods to interact with other partitions or servers.

“HSL OptiConnect” on page 49

High-Speed link (HSL) OptiConnect provides high speed system-to-system communication.

“SPD OptiConnect” on page 51

SPD OptiConnect allows a partition to communicate with another server or another partition that also has the OptiConnect hardware.

Related tasks

“Hardware for logical partitions” on page 5

Understand the basic hardware concepts and requirements to partition your server.

Related information

Opticonnect

Virtual Ethernet:

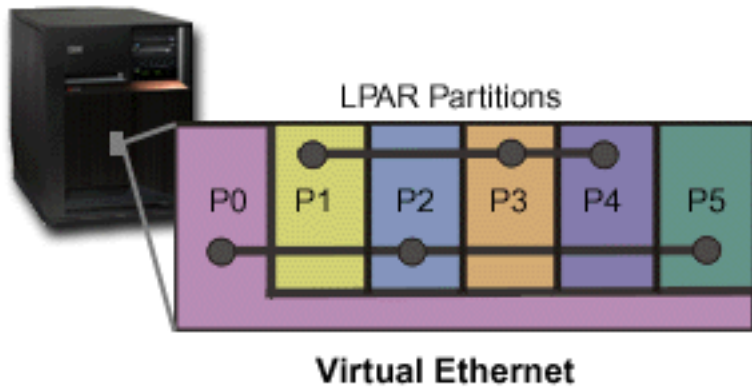

Virtual Ethernet enables you to establish communication via TCP/IP between logical partitions. For each of the 16 ports enabled, the system will create a virtual Ethernet communications port, such as CMNxx with a resource type of 268C. Logical partitions assigned to the same virtual Ethernet then become available to communicate through that link. A physical system allows you to configure up to 16 different virtual local area networks. Virtual ethernet provides the same function as using a 1Gb Ethernet adapter. Token Ring or Ethernet 10Mbps and 100Mbps local area networks are not supported with virtual Ethernet. Virtual Ethernet requires V5R1 and later releases and can be used without any additional hardware or software.

For a scenario illustrating how you can set up Virtual Ethernet on your server, see [Create a Virtual Ethernet for interpartition communications](#).

High-Speed link (HSL) OptiConnect:

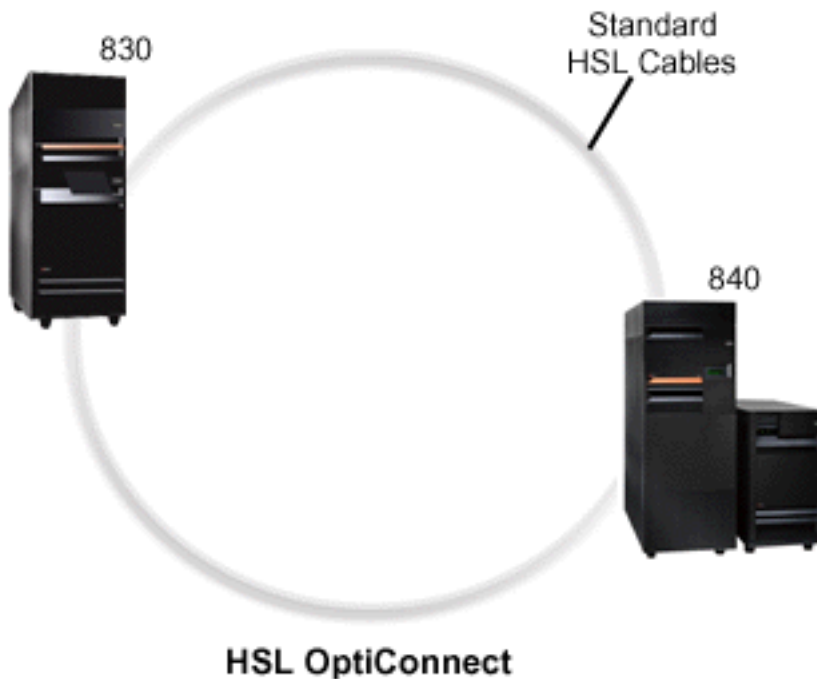

High-Speed link (HSL) OptiConnect provides high speed system-to-system communication for PCI-based models. It requires standard HSL cables, but no additional hardware is required. To use HSL

OptiConnect, you need to purchase OptiConnect for i5/OS software (a priced optional feature). The OptiConnect software will choose the Virtual OptiConnect path over a HSL or SPD OptiConnect external path if multiple paths are available.

You may enable HSL OptiConnect to other systems at any time for any partition within the system. But, you must install OptiConnect for i5/OS software before this feature can be used. When you enable or disable HSL OptiConnect, the changes take effect immediately.

Virtual OptiConnect:

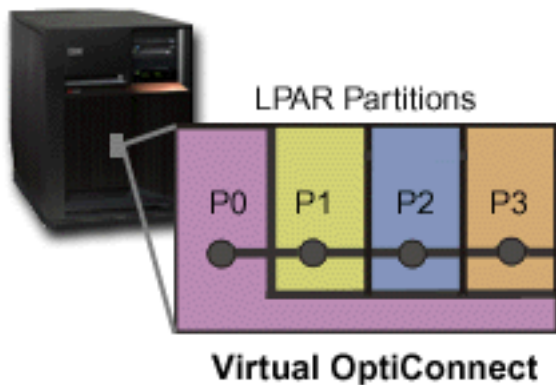

Virtual OptiConnect emulates external OptiConnect hardware by providing a virtual bus between logical partitions. You can use virtual OptiConnect without any additional hardware requirements. To use virtual OptiConnect, you only need to purchase OptiConnect for i5/OS (a priced optional feature).

The OptiConnect software will choose the virtual OptiConnect path over a HSL or SPD OptiConnect external path if multiple paths are available.

You may enable Virtual OptiConnect for a logical partition at any time. But, you must install OptiConnect for i5/OS software before this feature can be used. When you enable or disable Virtual OptiConnect, the changes take effect immediately.

SPD OptiConnect:

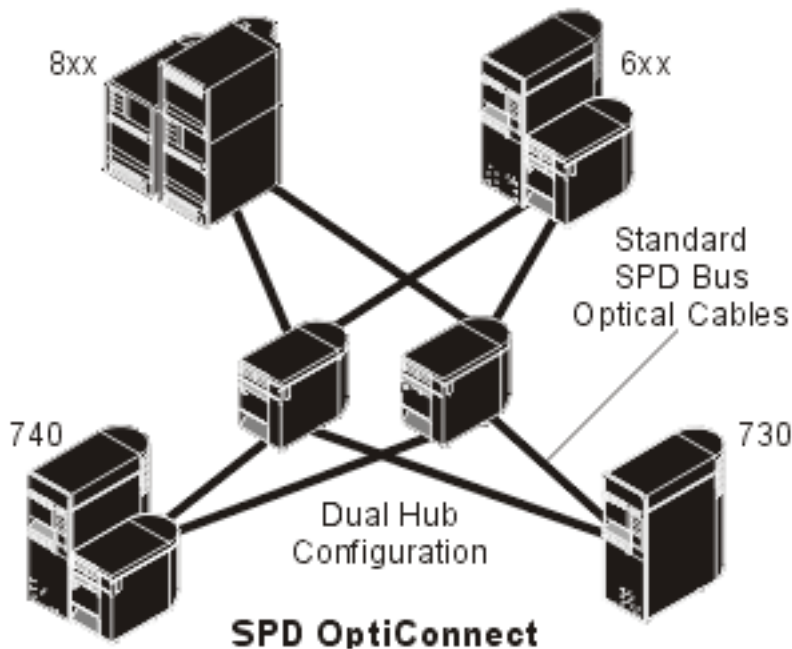

SPD OptiConnect is a combination of hardware and software that allows you to connect multiple high-end iSeries servers through a high-speed, fiber-optic bus. This combination of optical bus speeds and efficient software makes OptiConnect a viable solution, providing multiple routes to the database. You can run both APPC or TCP/IP communications protocols over OptiConnect. TCP/IP support was added to OptiConnect beginning with OS/400 or i5/OS V4R4.

In order to use OptiConnect, you must purchase the hardware and OptiConnect for i5/OS (a priced feature).

For each logical partition that participates in external OptiConnect, you need a dedicated bus. You can not assign this bus as shared.

For more information about OptiConnect, see OptiConnect for OS/400.

Back to hardware for logical partitions.

Logical and guest partition scenarios

Read logical and guest partition scenarios to understand how a partitioned server can be configured and used.

The following scenarios help you to understand how you can configure and use logical and guest partitions on your iSeries server. These scenarios introduce some common logical and guest partition implementations.

Related concepts

“How logical partitioning can work for you” on page 4

Understand the advantages of partitioning your server and practical scenarios your company can use with this advanced technology.

Related information

Networking scenarios

Logical partition scenario: Server consolidation

This scenario demonstrates how workload consolidation can be achieved on an iSeries server.

Situation

You are the system administrator for a small technology company. You are responsible for maintaining 3 servers. Currently, server 1 maintains payroll and technical data for the company. Server 2 maintains development projects while server 3 serves as the production box. Management wants to reduce expenses and asked you for your suggestions. You believe partitioning will streamline the company's information technology (IT) operations and improve server availability. You suggest they consolidate servers and partition one iSeries server. You have consulted with an IBM Business Partner and verified that an 840 iSeries model will meet your company's needs. The server has arrived and your hardware has been assigned. What should you do?

Objectives

The objectives of this scenario are as follows:

- Create or use a service tools user ID with LPAR administrator authority.
- Configure the Service Tools Server.
- Create 4 partitions on the iSeries server.

Solution

You must complete each of these tasks to create the 3 secondary partitions described in this scenario.

Create a service tools user ID:

Create a service tools user ID profile with LPAR administrator authority.

It is recommended that you use a profile other than QSECOFR. To create a logical partition administration authority (which enables all operation task as well) profile, perform the following steps:

1. Start DST as QSECOFR or with any other user ID with Service tool security privilege.
2. From the Use Dedicated Service Tools display, select option 5 (Work with DST environment).
3. From the Work with DST Environment display, select option 3 (Service tools user profiles).
4. From the Work with User Profiles display, select option 1 (Create) to create a new user profile and password.
5. Ensure that the **System partitions-administration** privilege is granted.

Add the service tools server:

Before you can use iSeries Navigator to work with logical partitions you must add the service tools server to the iSeries.

To configure the service tools server, follow these steps:

1. From an i5/OS command line, type ADDSRVTBLE (Add Service Table Entry) and press **Enter**. The Service Table Entry display appears. Enter the following information:

Note: The following information is case sensitive.

- Service: 'as-sts'
- PORT: 3000
- PROTOCOL: 'tcp'
- TEXT: 'Service Tools Server'

- ALIAS: 'AS-ST5'
2. Press **Enter** to add the table entry.
 3. Press F3 to Exit the Add Service Table Entry display.
 4. Enter ENDTCP to End TCP application servers.
 5. Enter STRTCP to Start TCP application servers.
 6. Once active, the service tool server starts when TCP/IP starts until the service table entry is removed.

Create the partitions:

You are now ready to create the partitions on your system.

The create wizard will help you set up your 3 logical partitions. To create a new logical partition using the service tools window, follow these steps:

1. In iSeries Navigator, select **My Connections** or your active environment.
2. Select **Open iSeries Navigator service tools window** in the Taskpad window. If the Taskpad window is not displayed, select **View** and select **Taskpad**.
3. Enter the **IP address** of the service tool network interface to which you want to connect. Click **OK**.
4. You will be prompted for your **Service Tools User ID and password**.
5. Right-click **Logical Partitions** and select **Configure Partitions**. You are now working in the Configure Logical Partitions window.
6. Right-click the **Physical System** and select **New Logical Partitions** to start the wizard.
7. Follow the instructions in the wizard to complete the task.

Your new partitions will be available after you restart the entire system. You can now begin to configure your console for your partitions and install the operating system, any LPPs, fixes, and application products.

Your single multiprocessing iSeries server is running as if it were four independent servers. The diagram shows the different servers running on the new iSeries.

Logical partition scenario: Scheduling movement of processing power

This scenario shows how you can dynamically reallocate resources based on workload peaks.

Situation

You are the system administrator for a company that has a partitioned 270 iSeries. Your company has 4 partitions with each partition owning .50 processing units. At the end of the each month, partition 2 needs .40 additional processing units due to workload demands. The workload demands on partition 3 are minimal at the end of the month. Your 270 only supports 2 processors. What should you do?

Objectives

The objectives of this scenario are as follows:

- Use dynamic movement of resources to move processing power to another partition.
- Schedule the movement of processing power to happen monthly.

Solution:

You must complete each of these tasks to move processing power and to schedule the move to occur monthly.

To schedule a shared processor move using the service tools window, follow these steps.

1. In iSeries Navigator, select **My Connections** or your active environment.
2. Select **Open iSeries Navigator service tools window** in the Taskpad window. If the Taskpad window is not displayed, select **View** and select **Taskpad**.
3. Enter the **IP address** of the service tool network interface to which you want to connect. Click **OK**.
4. You will be prompted for your **Service Tools User ID and password**.
5. Expand the system name select **Logical Partitions**.
6. Right-click the logical partition and select **Configure Partitions**. You are now working in the Configure Logical Partitions window.
7. Right-click the shared pool processors you want to move and select **Move**.
8. Specify the number of units in the shared processor pool to move in **Amount to move**.
9. Click **Schedule** to specify when you want the move to occur.
10. In the **Management Central Scheduler** window, select how often you want the processing power to move and what time you want the move to occur. Your selections will appear in the **Summary** at the bottom of the window.
11. Click **OK**.

You will want to set the processing power back to its original configuration once the monthly workload demands are over.

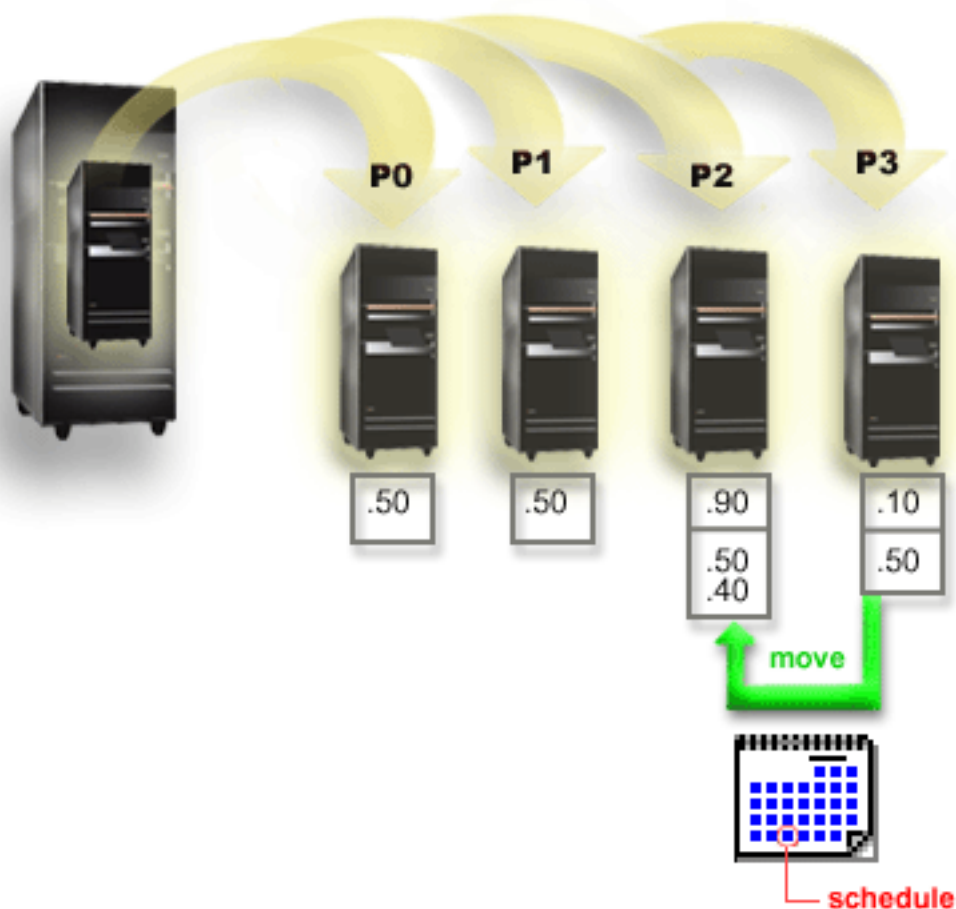

Guest partition scenario: Linux applications on the iSeries

This scenario demonstrates how you can use the reliability of the iSeries to run Linux application.

Situation



You are the system administrator of a company with three servers boxes. Each server performs unique tasks for your business. These servers are as follows:

- The IBM system runs the ordering system which is the core business application.
- The UNIX[®] web server is your corporate intranet web server.
- The Microsoft[®] based file server is used for sharing and backing up files.

These servers provide services to computers on your company's network. Your company wants to consolidate aging equipment to streamline the company's information technology (IT) operations and to improve server availability. The company also wants to increase application flexibility using an open-source operating system. What should you do?

Solution

The following image shows the consolidated iSeries server running logical and guest partitions.

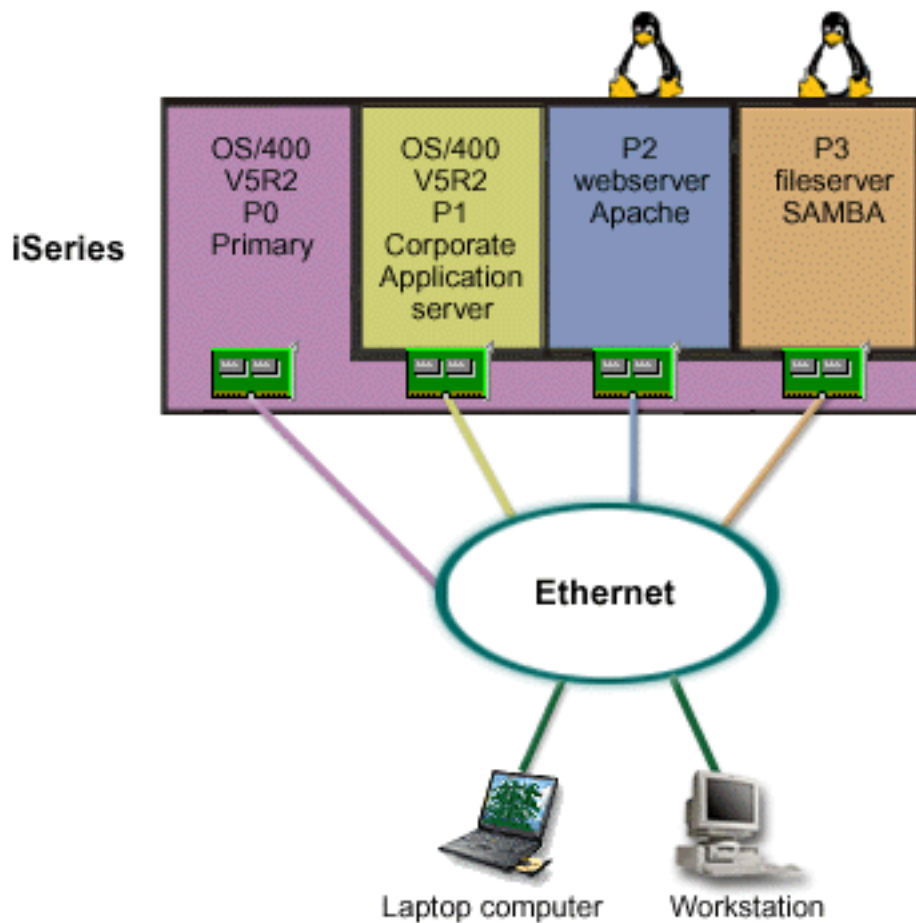

After researching and planning your partitioned environment, you created four partitions on your new server using iSeries Navigator. You allocated the minimum amount of hardware resources to your primary partition. All of the information on your older AS/400 was migrated to partition P1 running OS/400 V5R2. This release provides the flexibility of dynamically moving logical partition resources among partitions without a system restart. You installed the Linux operating system on partition P2 and P3. Partition P2 runs Apache and is your HTTP server. You installed the Samba software to partition P3. This partition provides file and print services to Server Message Block (SMB) clients.

All of the partitions own directly attached LAN adapters. Each of these LAN adapters are connected to the corporate network. Your employees are still able to access data from each of these partitions using either their laptop computers or workstation.

Now that you have your new configuration, you are still concerned about protecting the corporate network. You believe that your current firewall solution is inadequate and you want a more customized firewall application.

Related concepts

“Guest partition scenario: Linux firewall” on page 38

This scenario demonstrates how you can implement a firewall using a guest partition running Linux.

Guest partition scenario: Linux firewall

This scenario demonstrates how you can implement a firewall using a guest partition running Linux.

Situation

You are the system administrator of a company that has just consolidated your company's workload to a new iSeries server. Your new iSeries configuration has four partitions. You are running in a supported mixed environment with i5/OS partitions and guest partitions running Linux. You have a separate system with a firewall installed to protect the corporate network from untrusted data. However, that system is outdated and very expensive to maintain. You still want to protect your network what should you do?

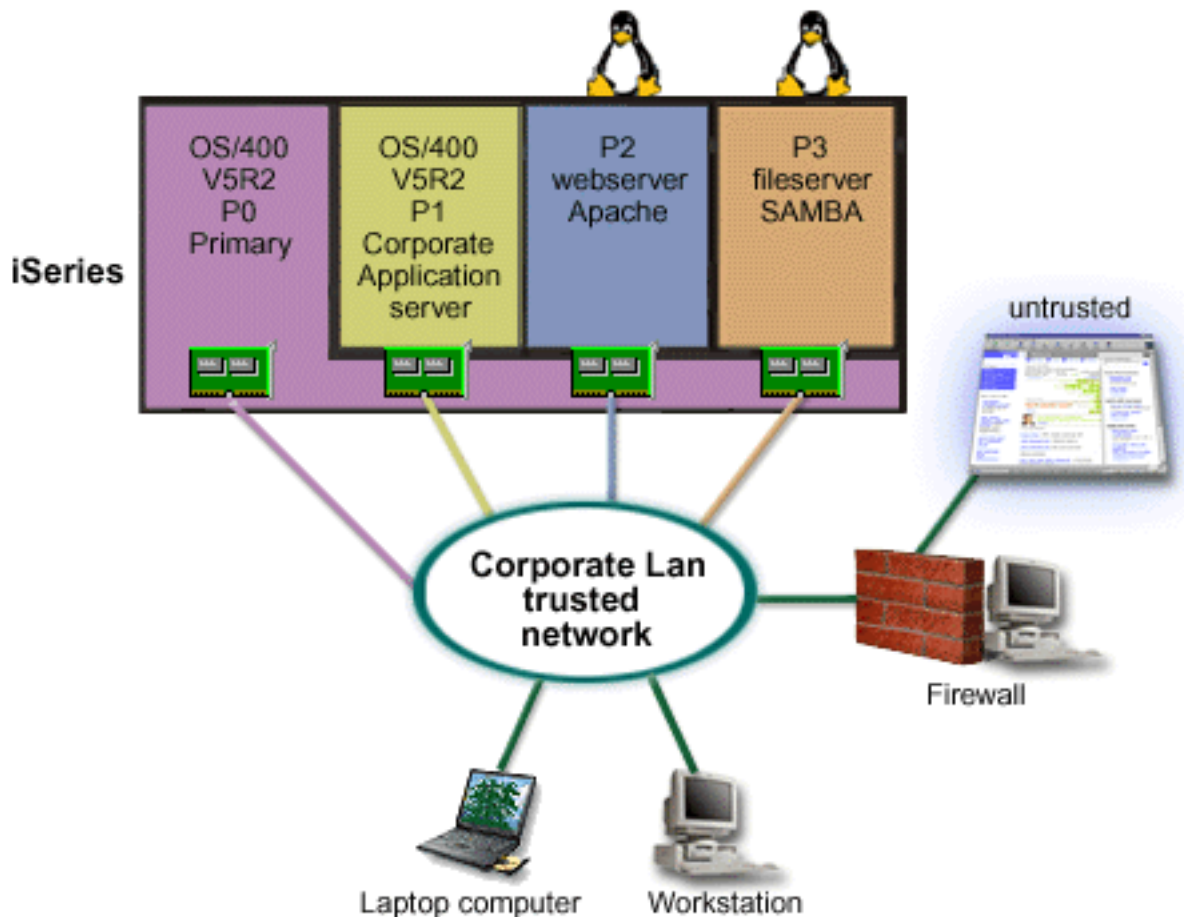

Solution using directly attached LAN adapters

Attention: Directly attached I/O resources are under the control of the Linux operating system.

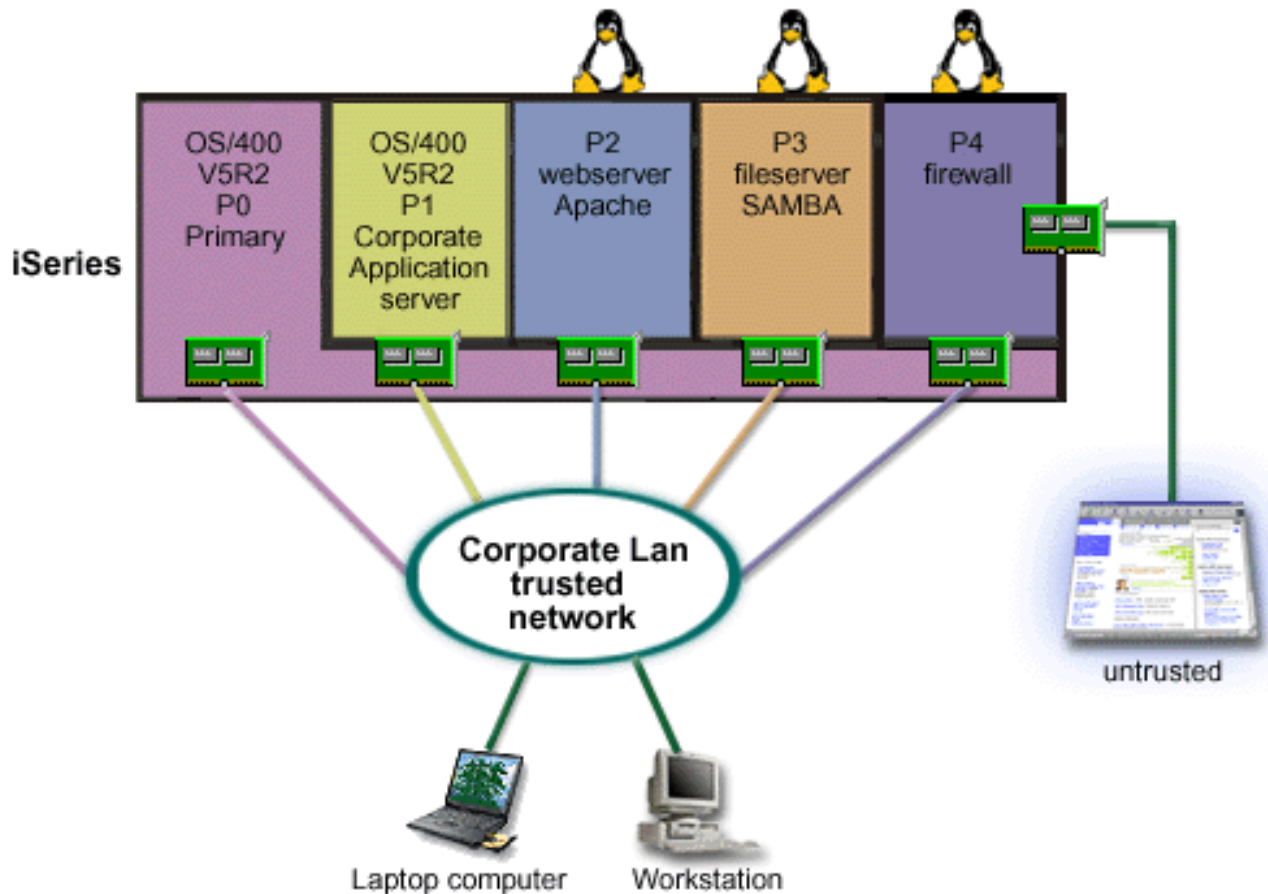

You had the hardware resources on your server to create another guest partition using iSeries Navigator. You installed Linux in partition P4. The firewall is built into the kernel that you are using. Your Linux firewall partition owns a directly attached LAN adapter that protects the entire system from untrusted data.

While your employees are able to use their laptop computers and workstations to connect to the trusted corporate network, you have the added assurance that your entire Corporate LAN is protected with your iSeries Linux firewall partition.

Solution using virtual Ethernet adapters

Attention: Virtual I/O resources are devices owned by the hosting i5/OS partition that provide I/O function to the guest partition.

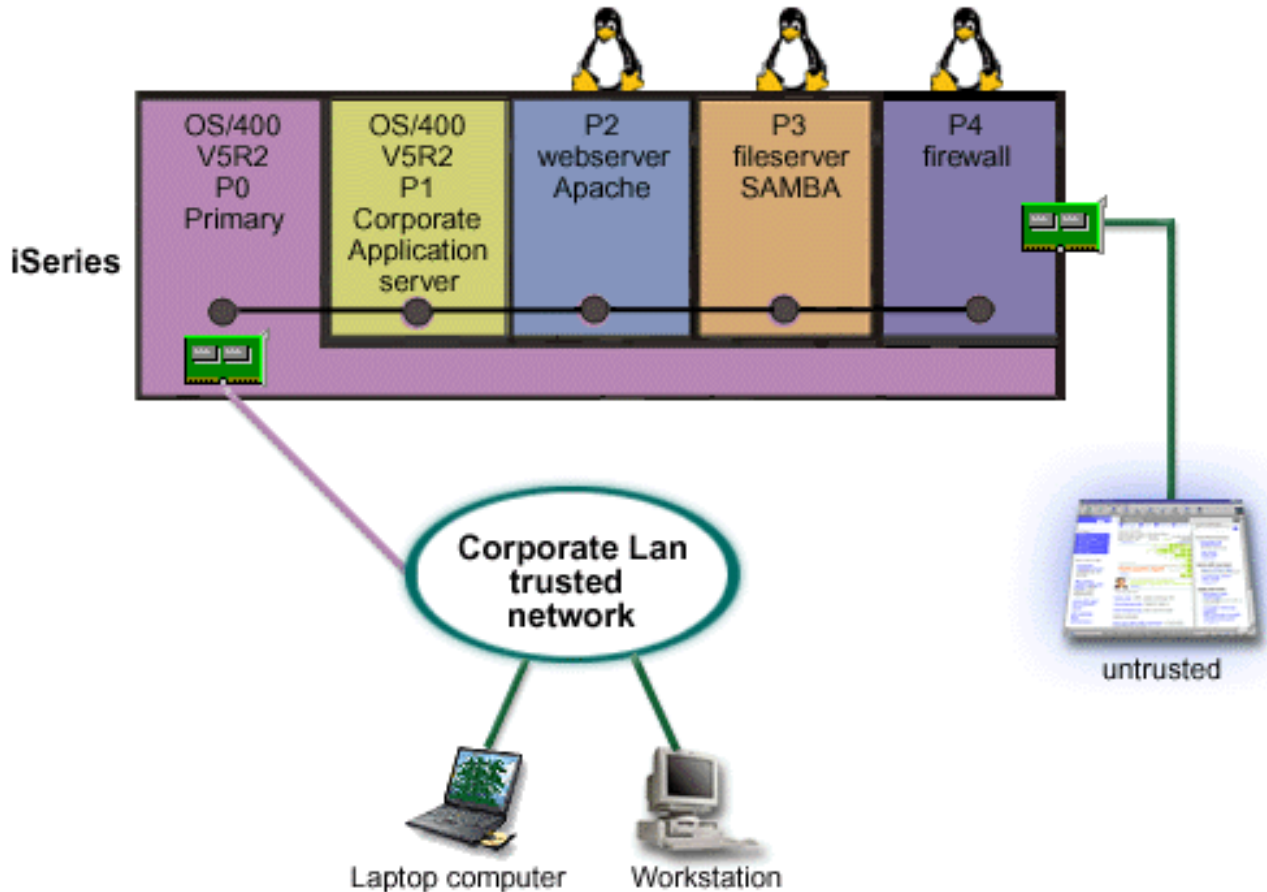

You created and installed Linux in a guest partition on your iSeries. However, you don't want to use a separate physical ethernet adapter for each partition, so you decide to use virtual ethernet to connect your partitions to the network. Your new Linux partition has a directly attached LAN adapter that connects your firewall to the untrusted network. Your primary partition owns a directly attached LAN adapter so your iSeries server can be connected to the trusted network. All of your partitions are able to communicate with each other and the Corporate Lan because they use virtual Ethernet.

Although you reduced the number of directly attached LAN adapters in this configuration, your entire network is still protected by the Linux firewall partition.

Related concepts

"Guest partition scenario: Linux applications on the iSeries" on page 35

This scenario demonstrates how you can use the reliability of the iSeries to run Linux application.

Plan for logical partitions

Understand the hardware and software requirements needed to successfully implement logical partitions. Read and go through the preorder tasks of completing the planning work sheet.

Once you understand logical partition concepts, you are ready to develop a plan that evaluates your hardware resources, software release levels, and your company's immediate and future workload demands. This section guides you through the necessary steps in the planning process before you create partitions on your iSeries server.

Related concepts

“Logical partition concepts” on page 2

Use this information to get the technical facts about logical partitions to find out what you need to know about your hardware, and to discover the multiple uses you can get from logical partitions.

Related tasks

“Hardware for logical partitions” on page 5

Understand the basic hardware concepts and requirements to partition your server.

“Create logical partitions” on page 56

Find information about the iSeries Navigator wizard that guides you through the process of creating logical partitions on your server.

Hardware requirements for logical partitions

Determine if your hardware resources meet the minimum requirements needed to partition your server. Evaluate each iSeries model to determine how your hardware will function once you partition your server.

During the process of planning for logical partitions, you must decide how you want to configure hardware resources. You can configure each server with logical partitions differently based on the following topics.

Related concepts

“Design your logical partitions” on page 53

Perform capacity planning and complete the planning worksheets needed to successfully create partitions on your server. Examples of capacity planning worksheets and planning hardware worksheets guide you through the process.

Determine the possible number of logical partitions:

The number of processors you want to add to a logical partition depends on the planned workload for the partition and the desired level of performance.

The number of processors you want to add to a logical partition depends on the planned workload for the partition and the desired level of performance. The number of partitions supported depends on the number of processors in the server model. If you are running release V5R1 or later, the 820, 830, and 840 models can have up to 32 logical partitions using the shared processor pool. The 820, 830, and 840 models are also designed to have up to 24 logical partitions using dedicated processors. The 890 model supports up to 32 logical partitions using dedicated processors.

For estimation purposes, approximately each processor of a server offers 1/(total number of processors on the server) of the total Commercial Processing Workload (CPW) performance available through that processor feature.

Refer to the Logical Partition web site for additional information on performing Capacity Planning  for your iSeries server.

Related concepts

“Logical partition concept: shared processor pool” on page 14

The shared processing pool allows you to assign partial processors to a logical partition.

“Logical partition concept: dedicated processor” on page 13

Dedicated processors are whole processors that are used exclusively by the partition to which they are assigned. The dedicated processor handles the processing for a specific logical partition.

“How logical partitioning can work for you” on page 4

Understand the advantages of partitioning your server and practical scenarios your company can use with this advanced technology.

Select bus-level or IOP-level partitioning:

Depending on your needs, there can be advantages to partitioning your I/O resources in different ways.

Bus-level partitioning

With bus-level I/O partitioning, you dedicate an I/O bus and all resources on the bus to the same partition. A partition using the bus-level configuration, all I/O (included the alternate IPL device, console, and electronic customer support device) is dedicated and no resources are dynamically switched into or out of the partition. On a server that has partitions at the bus level, all buses are owned dedicated by their respected partitions and no devices are switched.

Bus-level logical partitions allow for:

- Better problem isolation and therefore higher availability.
- Better performance.
- Simplified hardware management.

IOP-level partitioning

When you partition a bus at the IOP level, you share the bus and divide up the I/O resources by IOP. This type of logical partitions allows for:

- Greater flexibility with partition I/O subsystems.
- Potential cost reduction by eliminating some expansion units that you may need to support additional buses.
- Optimization of hardware resources to avoid server limits such as 19 buses per server (only on AS/400e™ models).
- The ability to dynamically switch an IOP from one logical partition to another without the need to restart the server.
- Simplified configuration planning since hardware movement is not necessary.

Additionally, it is possible to configure a partition to utilize both dedicated buses and dedicated IOPs on shared buses.

Related concepts

“Dynamically switching IOPs between partitions” on page 9

A powerful advantage of logical partitions is ability to dynamically switch an IOP from one partition to another.

“Choose dedicated or switchable IOP and devices for logical partitions”

Use this information to determine if dedicated or switchable IOP are right for your partitioned environment.

Choose dedicated or switchable IOP and devices for logical partitions:

Use this information to determine if dedicated or switchable IOP are right for your partitioned environment.

IOPs that are candidates for switching include:

- IOPs that control high cost devices.
- IOPs that control low utilization devices and low demand devices.
- IOPs that solely control the target device or devices.

The IBM recommended approach is to confine all hardware within a partition. This is not always a cost-effective solution. With some devices it may be preferable to share them among partitions. Although partitions do not support concurrent device sharing, IOP-level switching may be an effective solution.

- **Advantages of switching IOPs and devices**

- Reduced cost.
- Fewer card positions needed. In some cases, this could mean that you need fewer expansion units.
- **Disadvantages of switching IOPs and devices**
 - Inconvenience of having to schedule use of switchable IOPs and devices.

Attention: For external tape (for instance, 3590), it is possible to have one tape device, but separate IOPs for each partition that will use it. A partition requesting use of the device receives a "busy" indication if it is in use by another partition.

Before implementing a switchable IOP and other devices, you should also consider other possible alternatives. To share devices among partitions, you can apply the same techniques that are used to share devices among separate physical servers:

- Use multiple IOPs, one in each partition, for devices that support multiple connections (some high end tape drives).
- Use multiple IOPs, one in each partition and use a switch box for devices that only support single connections (printers, or some high end tape drives).
- Use multiple IOPs and multiple devices in each partition for a self-contained solution (internal removable media devices).

Related concepts

"Select bus-level or IOP-level partitioning" on page 41

Depending on your needs, there can be advantages to partitioning your I/O resources in different ways.

Select dedicated or shared processors:

Partitions can use one of two modes of processors on the iSeries server. The results of your capacity planning and system hardware configuration will help you make a decision about utilizing dedicated processors or the shared processor pool for each partition.

Depending on workload demands for each partition, one partition can use dedicated processors and another partition can use the shared processor pool.

Dedicated processors allows you to assign a whole processor to a partition. You can assign dedicated processors to a partition as long as processors are available or unassigned.

The shared processor pool allows you to assign partial processors to a partition. The processors are held in the shared processing pool and are shared among the logical partitions. A minimum of 0.10 processing units per virtual processor can be configured for any partition using shared processors. The primary partition may require more than 0.10 processing units when starting secondary partitions, otherwise timeout conditions may occur with resources communicating directly with the primary partition. Each system processing capacity and partition configuration needs to be evaluated to determine reasonable processor units for primary and secondary partitions.

To adjust to workload demands, you can move shared processing resources without needing to restart the partition. Use of the shared processor pool is preferred for small (less than one processor) partitions or where the use of a whole processor increments are too great for the partition.

Perform dynamic movement of resources:

You can dynamically move processors, memory, and interactive performance.

Dynamic movement of resources provides users the ability to move resources between partitions without requiring a partition or system restart. To take full advantage of this enhancement your primary and secondary partitions must be running OS/400 or i5/OS V5R1 or V5R2.

Related concepts

“Logical partition release support” on page 25

Systems with logical partitions have the capability to support more than one version of OS/400 or i5/OS.

“Select interactive performance”

Every physical system is purchased with a specific quantity of interactive performance which is allocated to the partition as a percentage of the total system interactive performance.

“Determine the amount of memory to move” on page 45

Primary partitions need a minimum of 256 MB of memory.

“Allocate processor power” on page 46

The ability to move processor power dynamically becomes important when you need to adjust to changing workloads.

Select interactive performance:

Every physical system is purchased with a specific quantity of interactive performance which is allocated to the partition as a percentage of the total system interactive performance.

Interactive performance enables you to run jobs that require user interaction in contrast to batch jobs which require no user interaction. Each partition has a unique requirement for the amount of interactive performance.

To move interactive performance, you have to establish a minimum and maximum range within which you can move the resource without needing to restart the logical partition. If you change either the minimum or maximum value you will have to restart the partition.

You can specify an interactive performance minimum value equal to the minimum amount of interactive performance needed to support the logical partition. The maximum value must be less than the amount of interactive performance available on the system. The maximum interactive performance is limited by the number of processors in a partition.

Relationship between 5250 interactive capacity, logical partitioning, and Capacity on Demand

You allocate 5250 interactive capacity across logical partitions by specifying a percentage of the overall available capacity. The method you use to allocate 5250 interactive capacity to a logical partition works the same on all iSeries, models, whether the models have standby processors or not:

- For servers with interactive features, you can allocate a percentage of the interactive feature capacity to be made available for 5250 interactive processing.
- For Enterprise Edition servers, you can allocate a percentage of the active processor capacity to be made available for 5250 interactive processing .
- For Standard Edition servers, there is no 5250 interactive processing capacity to allocate. However, up to 100% of the active processor capacity is available to any partition with a single job doing 5250 interactive processing.

The rules for assigning interactive capacity are as follows.

The server restricts you from assigning more 5250 interactive capacity to a partition than the assigned processor capacity in the same partition.

This restriction prevents you from wasting 5250 interactive capacity. For example, for a server with six installed and activated processors, each processor has approximately 16.7% of the total server capacity. For a single-processor partition on this server with an Enterprise Edition, the maximum 5250 interactive allocation can be 17% of the total 5250 interactive capacity, which allows you to allocate slightly more

5250 interactive capacity than the partition's processor capacity. However, you cannot allocate 17% on all of the six one-processor partitions because the total exceeds 100%.

The percentage of interactive capacity you assign is based on the total number of installed processors, whether they are activated or not.

However, you can only use the interactive capacity for activated processors. For example, for a server with six installed processors and three activated processors with three one-processor partition, you cannot allocate more than 50% of interactive capacity across all three processors. This is because you only have access to interactive capacity for the three activated processors. Therefore if you create three one-processor partitions, you can allocate 16.7% interactive capacity for each partition. But if you attempt to allocate 16.7% interactive capacity for two partitions and 30% interactive for the third partition, the third partition will fail.

Related concepts

“Perform dynamic movement of resources” on page 43

You can dynamically move processors, memory, and interactive performance.

Determine the amount of memory to move:

Primary partitions need a minimum of 256 MB of memory.

The minimum memory of V5R1 and V5R2 secondary partitions is 128 MB. V4R4 and V4R5 secondary partitions minimum memory requirement remains 64 MB. Depending on the number of secondary partitions on the server, the primary partition may need more memory to successfully manage the partitions on the server.

To dynamically move memory, you have to establish a minimum and maximum range within which you can move the resource without needing to restart the logical partition. Changing the maximum value requires a system restart. Changing the minimum value only requires you to restart the partition. Due to performance reasons, you are recommended to specify the maximum value that is close to the amount of memory the partition will use on a regular basis. By specifying a maximum value higher than what is needed for the partition, you waste valuable memory resources. Minimum values dictate what is required to restart the partition. If the minimum value is not met for all logical partitions, only the primary will restart. You can specify a memory minimum value as low as 0. A value of 0 in any partition creates a non-functioning partition. If the primary partition has been restarted (a system restart) after the secondary partition was set to 0, then another system restart is required when the secondary memory value is changed. If the changes are made to the memory within the same primary restart, then a system restart is not required to make changes to the memory allocations.

The full amount of memory that you assign to a logical partition may not be available for the partition's use. Static memory overhead required to support the assigned maximum memory will affect the reserved or hidden memory amount. This static memory overhead will also influence the minimum memory size of a partition.

When you dynamically remove memory from a logical partition, the currently allocated amount may not be reduced to the new value you have specified until you restart the partition. This is dependent upon factors in the running operating system in that partition. Runtime values are based on memory the partition needs to complete an assigned task.

Related concepts

“Perform dynamic movement of resources” on page 43

You can dynamically move processors, memory, and interactive performance.

Related tasks

“Dynamically move memory” on page 72

Memory in each logical partition operates within its assigned minimum and maximum values.

Allocate processor power:

The ability to move processor power dynamically becomes important when you need to adjust to changing workloads.

Processors have minimum and maximum values associated with them. These values enable you to establish a range within which you can dynamically move the resource without needing to restart the logical partition. Minimum values dictate what is required to restart the partition. A minimum value of zero is valid. A partition with zero processors or processing units is not functional. For example, a test partition can free up valuable processing power to apply to a production partition if needed. Once the demand on the production partition is over, the processing power can be moved back to the test partition.

For both shared and dedicated processors you can specify a minimum value equal to the minimum amount of processing power needed to support the logical partition. The maximum value cannot be more than or equal to the amount of processing power available on the system. If you change either the minimum or maximum value, it will require you to restart the entire partition. If the minimum value is not met for all logical partitions, only the primary will restart.

Note for Partitions Not Using DB2 UDB Symmetric Multiprocessing (SMP): Changing processor resources dynamically does not affect the number of tasks used to rebuild database access paths. To apply the processor resource change to database access paths, you need to restart the partition. If you have SMP enabled, no restart is required.

Related concepts

“Perform dynamic movement of resources” on page 43

You can dynamically move processors, memory, and interactive performance.

Evaluate the hardware limitations of the iSeries servers:

The 6xx, 7xx, Sxx, 8xx, and 890 n-way base servers support logical partitions (LPAR).

However, the 6xx, 7xx, and Sx0 models do not support the shared processor pool or Linux in a secondary partition.

For upgrade customers, the current physical placement of hardware may restrict your configuration choices. For server-specific information, consult the Technical information section on the Logical Partition



web site, and contact your business partner, marketing representative, or service specialist.

Be sure that you have the right hardware and software for your server. The following table list the LPAR hardware function by model.

Available hardware function, listed by model:

Hardware function	AS/400e models Sx0, 6xx, and 7xx	iSeries model 820, 830, and 840	iSeries model 270	iSeries model 890
Logical partitioning	<p>With Version 4 Release 4 (V4R4) through V5R2 in the primary partition:</p> <ul style="list-style-type: none"> • S20 processor feature codes 2165, 2166, 2170, 2177, 2178 • S30 processor feature codes 2258, 2259, 2260, 2320, 2321, 2322 • S40 all processor features • 620 processor feature code 2182 • 640 processor feature codes 2238, 2239 • 650 all processor features <p>With V4R4 and later in the primary partition:</p> <ul style="list-style-type: none"> • 720 processor features 2063, 2064 • 730 processor features 2066, 2067, 2068 • 740 all processor features 	<p>With V4R5 in the primary partition:</p> <ul style="list-style-type: none"> • 820 processor feature codes 2397, 2398, 2426, 2427 • 830 all processor feature codes • 840 all processor feature codes <p>With V5R1 and later in the primary partition:</p> <ul style="list-style-type: none"> • 820 all processor feature codes • 830 all processor feature codes • 840 all processor feature codes 	<p>No LPAR support with V4R5 in the primary partition.</p> <p>With V5R1 in the primary partition:</p> <ul style="list-style-type: none"> • 270 processor feature codes 2431, 2432, 2434, 2452, 2454 	<p>With V5R2 and later in the primary partition:</p> <ul style="list-style-type: none"> • 810 all processor feature codes • 825 all processor feature codes • 870 all processor feature codes • 890 all processor feature codes
Shared processor pool	No	Yes	Yes	Yes
Linux	No	Yes for all models excluding 820 processor feature codes 2303, 2395, 2396, 2425.	Yes for all 270 models with feature codes 2431, 2432, 2434, 2452, 2454.	Yes

You can create a maximum of one logical partitions for each installed processor using dedicated processors. Or you can use the shared processor pool and specify a partial amount of processors for the partition.

Related concepts

“i5/OS logical partition function by release” on page 27

The capabilities available in i5/OS logical partitions vary with each operating system release.

“Logical partition release support” on page 25

Systems with logical partitions have the capability to support more than one version of OS/400 or i5/OS.

Networking for logical partitions:

Logical partitions can use any of several communication methods to interact with other partitions or servers.

The type of communication options that you use will depend on your business needs. You can use any combination (or none) of these communication methods within a partition.

Related concepts

“Communication options for logical partitions” on page 29

Learn how logical partitions are able to share data between partitions or between servers.

“Virtual Ethernet”

Virtual Ethernet enables you to establish communication via TCP/IP between logical partitions.

“HSL OptiConnect” on page 49

High-Speed link (HSL) OptiConnect provides high speed system-to-system communication.

“Virtual OptiConnect” on page 49

Virtual OptiConnect allows one partition to communicate with another partition if both partitions have virtual OptiConnect enabled.

“SPD OptiConnect” on page 51

SPD OptiConnect allows a partition to communicate with another server or another partition that also has the OptiConnect hardware.

Related information

Opticonnect

Virtual Ethernet:

Virtual Ethernet enables you to establish communication via TCP/IP between logical partitions.

Each partition can define up to 16 virtual local area networks. Partitions defined to use the same port can communicate through that link.

Virtual Ethernet can be used without any additional hardware or software.

Related concepts

“Networking for logical partitions” on page 47

Logical partitions can use any of several communication methods to interact with other partitions or servers.

Related information

TCP/IP setup

Configure an Ethernet line description for virtual Ethernet:

To configure i5/OS to use virtual Ethernet, you must configure the virtual IOA from the primary partition, then create an Ethernet line description.

The system will create a virtual Ethernet communications port, such as CMNxx with a resource type of 268C. Logical partitions assigned to the same virtual Ethernet then become available to communicate through that link.

To configure a new Ethernet line description to support virtual Ethernet, complete the following steps:

1. At the command line, type WRKHDWRSC *CMN and press **Enter**.
2. From the Work with Communication Resources display, select option 7 (Display resource detail) next to the appropriate virtual Ethernet port. The Ethernet port identified as a 268C is the virtual Ethernet resource. There will be one for each virtual Ethernet that is connected to the partition.
3. From the Display Resource Detail display, scroll down to find the port address. The port address corresponds to the virtual Ethernet you selected during the configuration of the partition.

4. From the Work with Communication Resources display, select option 5 (Work with configuration descriptions) next to the appropriate virtual Ethernet port and press **Enter**.
5. From the Work with Configuration Descriptions display, select option 1 (Create) enter the name of the line description and press Enter.
6. From the Create Line Description Ethernet (CRTLINETH) display, provide the following information:

LINESPEED (1G)
 DUPLEX (*FULL)
 FRAMESIZE (8096)
 Press Enter.
 Press Enter.

From the Work with Configuration Description display, you will see a message stating the line description has been created.

Configure TCP/IP for virtual Ethernet:

To assign an IP address to an Ethernet line description, you must configure TCP/IP.

Related concepts

Configure TCP/IP using the character-based interface

HSL OptiConnect:

High-Speed link (HSL) OptiConnect provides high speed system-to-system communication.

This cannot be used for partition to partition communication. HSL OptiConnect requires standard HSL cables, but no additional hardware. You must purchase OptiConnect (a priced optional feature) for operating system software before this feature can be used.

Related concepts

“Networking for logical partitions” on page 47

Logical partitions can use any of several communication methods to interact with other partitions or servers.

“Communication options for logical partitions” on page 29

Learn how logical partitions are able to share data between partitions or between servers.

Related information

Opticonnect

Virtual OptiConnect:

Virtual OptiConnect allows one partition to communicate with another partition if both partitions have virtual OptiConnect enabled.

Any partition can use virtual OptiConnect. You can enable virtual OptiConnect at any time. When you enable or disable virtual OptiConnect, the changes take effect immediately. No additional hardware is required to use virtual OptiConnect. However, you must purchase the OptiConnect (a priced optional feature) i5/OS software to use this feature.

Related concepts

“Networking for logical partitions” on page 47

Logical partitions can use any of several communication methods to interact with other partitions or servers.

Related tasks

“Configure TCP/IP for virtual OptiConnect”

Virtual OptiConnect emulates external OptiConnect hardware by providing a virtual bus between logical partitions.

“Configure SNA for virtual OptiConnect”

In IBM networks, Systems Network Architecture (SNA) is the layered logical structure, formats, protocols, and operational sequences that are used for transmitting information units through networks. SNA also controls the configuration and operation of networks.

Related information

Opticonnect

Configure TCP/IP for virtual OptiConnect:

Virtual OptiConnect emulates external OptiConnect hardware by providing a virtual bus between logical partitions.

You can use virtual OptiConnect without any additional hardware requirements. To use virtual OptiConnect, you only need to purchase OptiConnect for i5/OS (a priced optional feature).

To enable virtual OptiConnect, follow these steps:

1. In iSeries Navigator, expand **My Connections** or your active environment.
2. Select the primary partition of the system.
3. Expand **Configuration and Service** and select **Logical Partitions**.
4. Right-click the logical partition and select **Properties**.
5. Select the **Options** page.
6. Select the **Virtual (internal) OptiConnect** Click **Help** if you need more information on this field.
7. Click **OK**.

Note: The internet address is assigned to a line description of *OPC.

Related concepts

“Virtual OptiConnect” on page 49

Virtual OptiConnect allows one partition to communicate with another partition if both partitions have virtual OptiConnect enabled.

Configure TCP/IP using the character-based interface

Configure SNA for virtual OptiConnect:

In IBM networks, Systems Network Architecture (SNA) is the layered logical structure, formats, protocols, and operational sequences that are used for transmitting information units through networks. SNA also controls the configuration and operation of networks.

You can use SNA communications in a partitioned environment. SNA communication is limited to APPC using virtual OptiConnect. You can only communicate directly between two servers. In order to communicate with partitions that are not part of your server, you will have to access the server that has access to the network.

To establish an APPC connection from a primary partition to a secondary partition, follow these steps:

1. At a command line, enter the command CRTCTLAPPC and press **Enter**.
2. From the Create Controller Description (APPC) display, provide the following information:

Controller description (Name)
Link type (*OPC)

Remote System Name (System name)
Data link role (*pri)
Text description

3. At the command line, enter the command CRTDEVAPPC and press **Enter**.
4. From the Create Device Description (APPC) display, provide the following information:

Device description (Name)
Option (*BASIC)
Category of device (*APPC)
Remote location (Provide the same system name found in the
Display Network Attributes (DSPNETA) display.)
Online at IPL (*YES)
Local location (Name)
Remote network identifier (*None)
Attached controller (Name)
APPN-capable (*NO)

To establish an APPC connection from a secondary partition, following these steps:

1. At a command line, enter the command CRTCTLAPPC and press **Enter**.
2. From the Create Controller Description (APPC) display, provide the following information:

Controller description (Name)
Link type (*OPC)
Remote System Name (System name)
Data link role (*SEC)
Text description

3. At the command line, enter the command CRTDEVAPPC and press **Enter**.
4. From the Create Device Description (APPC) display, provide the following information:

Device description (Name)
Option (*BASIC)
Category of device (*APPC)
Remote location (Name)
Online at IPL (*YES)
Local location (Name)
Remote network identifier (*None)
Attached controller (Name)
APPN-capable (*NO)

Related concepts

“Virtual OptiConnect” on page 49

Virtual OptiConnect allows one partition to communicate with another partition if both partitions have virtual OptiConnect enabled.

SPD OptiConnect:

SPD OptiConnect allows a partition to communicate with another server or another partition that also has the OptiConnect hardware.

Any partition that uses OptiConnect must have the OptiConnect hardware on a dedicated bus in the partition. The OptiConnect hardware can not be on a shared bus. Additionally, you must purchase OptiConnect (a priced optional feature) for i5/OS software.

Related concepts

“Networking for logical partitions” on page 47

Logical partitions can use any of several communication methods to interact with other partitions or servers.

“Communication options for logical partitions” on page 29

Learn how logical partitions are able to share data between partitions or between servers.

Opticonnect

Software requirements for logical partitions

Learn what release levels are supported and how you can partition your system to support new functions.

Only Version 4 Release 4 (V4R4) and later releases of the i5/OS (R) operating system support logical partitions. (All releases of the i5/OS(TM) operating system support logical partitions.) V4R4 is the earliest release that is supported in any logical partition.

You can install up to four different releases on a single server. The releases that you can install on a particular server depend upon which releases are supported on the server model and upon which release you choose to install on the primary partition.

If the primary partition is running V4R5 or earlier, you can install and run the following releases on the secondary partitions, provided that each release is supported by the server model:

- The release before the release on the primary partition
- The release on the primary partition
- The release after the release on the primary partition

The only exception to this rule is when the primary partition of 6xx, 7xx, or Sx0 servers runs V4R4. In this case, you can install V5R1 on a secondary partition of those servers.

If the primary partition is running V5R1 or later, you can install and run the following releases on the secondary partitions, provided that each release is supported by the server model:

- The release before the release on the primary partition
- The release on the primary partition
- The release after the release on the primary partition
- The second release after the release on the primary partition

The 6xx and Sx0 servers support all releases from V4R4 through V5R2. The 7xx servers support all releases from V4R4 through V5R3. The 6xx, 7xx, and Sx0 servers do not support the shared processor pool. Because of this, you can partition these models only if the server has 2 or more processors.

The 820, 830, 840, and 270 servers with a single processor support V5R1 and later releases on all logical partitions. The 820, 830, and 840 servers with 2 or more processors support V4R5 and later releases on all logical partitions. The 270 servers with 2 processors support V5R1 and later releases on the primary partition and V4R5 and later releases on secondary partitions.

The 810, 825, 870, and 890 servers only support V5R2 or later releases in the primary and secondary partitions.

Read more information about release support in Logical partition concepts.

Related concepts

“Logical partition release support” on page 25

Systems with logical partitions have the capability to support more than one version of OS/400 or i5/OS.

“Design your logical partitions”

Perform capacity planning and complete the planning worksheets needed to successfully create partitions on your server. Examples of capacity planning worksheets and planning hardware worksheets guide you through the process.

Plan for Linux in a guest partition

Prepare your server to run a non-i5/OS operating system in a partition. Understand the hardware resources needed to install Linux on a partition.

You can run Linux, a non-i5/OS operating system, in a guest partition. An iSeries server running Linux embraces new applications with the increased reliability over other hardware platforms.

Related concepts

Linux in a guest partition

Order a new server or upgrade an existing server with logical partitions

Determine if you need to purchase new hardware or upgrade existing hardware for your company. IBM can assist you in placing the correct order that meets your partition requirements.

Contact your IBM Marketing Representative or Business Partner to enter the order for your new server. You can enter the order by using the configurator. When placing the order for a server with logical partitions, specify feature code 0140 for each partition.

To upgrade an existing server with logical partitions, detailed planning must be performed prior to upgrading the server. It is highly recommended that all of the logical partition configuration actions be performed by an LPAR-trained services person. Refer to Convert expansion units in a partitioned environment for more information on upgrading an existing server with logical partition.

Provide hardware placement information to service providers:

Logical partitions require that certain resources for secondary partitions occupy specific card positions in System Expansion Units and Storage Expansion Units on iSeries servers.

The LVT output or the Configuration Planning Worksheets will provide the necessary card placement information to satisfy your specific partition requirements.

IBM Manufacturing places features in servers to optimize performance as a singlehandedly server. If you plan to order a new server to support logical partitions, some card movement may be required after customer installation. Card movement may be a billable to the customer. If you plan to upgrade an existing server to support logical partitions, the card placement instructions that usually accompany an upgrade may be incorrect. Additionally, some already-installed cards may need to be moved.

Design your logical partitions

Perform capacity planning and complete the planning worksheets needed to successfully create partitions on your server. Examples of capacity planning worksheets and planning hardware worksheets guide you through the process.

After understanding the hardware and software requirements for logical partitions, it is time to develop a detailed outline of your company’s immediate and future workload demands for each partition. You need to consider how these demands will change your system resources. You should focus on the workload demand in each partition and then determine the hardware resources required to achieve the desired server performance.

You can start the planning process for each partition on your server by completing the following topics.

Refer to the Logical Partition  web site for additional information on planning for logical partitions.

Related concepts

“Hardware requirements for logical partitions” on page 41

Determine if your hardware resources meet the minimum requirements needed to partition your server. Evaluate each iSeries model to determine how your hardware will function once you partition your server.

“Software requirements for logical partitions” on page 52

Learn what release levels are supported and how you can partition your system to support new functions.

Decide what runs in the primary and secondary partition:

Each secondary partition on an iSeries server acts as an independent system on the server.

However, these partitions maintain a dependency on the primary partition. It must be running to keep each secondary partition on the system accessible. With that in mind, deciding on what runs in the primary partition is important to maintain stability throughout your system.

If you have multiple production environments on the same server, it is recommended to configure the primary partition with the minimum amount of hardware resources and if necessary use the primary only for applications that are stable.

Secondary partitions can handle different types of workload demands without causing down time on the server. You can perform fixes or new release testing on secondary partitions before installing these packages to the primary partition. Applications that require high availability should be running in a secondary partition to minimize problems with the applications. You can also use the secondary partition to back-up data on another partition on the server. This way if data is lost the secondary partition responsible for backing up the information can be used without causing delays to your business schedule.

Enforce security in secondary partitions:

Secondary partitions act as independent servers on your iSeries.

In general, when making security decisions and performing security actions, you have to remember to plan and perform the task for each logical partition.

In order to access logical partition functions, you must first configure the service tools server. For more information on the service tools server, refer to [Configure the service tools server](#).

Related concepts

“Manage security for logical partitions” on page 67

Understand who has authority to perform logical partition tasks and how to restrict access to the system.

Capacity planning for logical partitions:

Capacity planning will help you determine how many partitions you need for your business and how much hardware you need in each partition.

You must perform capacity planning individually for each logical partition that you have or want on a server. Depending on the number of partitions you decide to create on your server, the primary partition may need more memory to successfully manage the partitions on the server.

See Capacity Planning  on the Logical Partition web site for more information. This information can help you to determine the resources necessary to achieve a desired performance.

Examples: Capacity planning:

Once you have decided you want to partition your iSeries server, you must perform capacity planning for each partition.

Capacity planning helps you determine the hardware configuration needed on your server to meet your business demands. Capacity planning results are key to the successful implementation of logical partitions.

Refer to the Logical Partition web site to read more information on Capacity Planning. 

Use the LPAR Validation Tool:

The LPAR Validation Tool (LVT) emulates an LPAR configuration and validates that the planned partitions are valid. In addition, LVT allows you to test the placement of i5/OS and Linux hardware within the system to ensure that the placement is valid.

Refer to the Logical Partition  web site for information on the LPAR Validation Tool.

Complete the Configuration Planning Worksheet:

It takes careful planning to create logical partitions on the iSeries . This includes planning for all the required hardware.

The Guide to Completing the Configuration Planning Worksheet on the Logical Partition  web site, gives a framework for providing the information necessary to build a server capable of supporting logical partitions. On the web site, you can also download the worksheet as a Lotus® Smartmaster, Microsoft Word, or HTML document (when prompted, save the document to your computer).

This planning worksheet can help you prepare the necessary information for completing the Configuration Planning Worksheet. The Configuration Planning Worksheet is available from the Logical Partition web site. 

Submit 6xx, 7xx, Sxx worksheets to IBM:

In order to help you, IBM must receive the following from you:

- Logical Partitions Configuration Planning Worksheet 
- Configurator output (in HTML or text file format)

Send these documents by using one of the following methods:

- E-mail: rchtsc@us.ibm.com
- Fax: (507) 286-5045

If sending by e-mail, include the documents as attachments to the e-mail.

IBM also provides assistance with the following:

- Technical conference calls with your IBM Marketing Representative or Business Partner
- Customized hardware configuration
- Customized order outline
- Onsite consulting, if needed
- Education

- Consulting services

Some of these services may be billable to the customer.

It is the responsibility of the IBM representative or Business Partner to provide the validated worksheets to the Hardware CE.

If assistance is needed for the LPAR planning process, contact your local Global Services (IGS) representative. Your IBM marketing representative can assist in locating your IGS representative.

Examples: Logical partitioning

Review examples of different iSeries models running variations of the logical partition concept. Create unique partition set-ups using Bus-level or IOP-level configurations.

The time you spend in planning will save you steps and avoid trouble during partition setup. The following detailed partitioning examples should provide a helpful guide:

Bus-level partitioning using a 840 server



Refer to the Logical Partition web site for more information on Bus-level partitioning using a 840 server.

IOP-level partitioning using a 840 server



Refer to the Logical Partition web site for more information on IOP-level partitioning using a 840 server.

Create logical partitions

Find information about the iSeries Navigator wizard that guides you through the process of creating logical partitions on your server.

Before you start to create logical partitions on your iSeries , see Plan for logical partitions for assistance. Refer to Back up your system, for instructions on performing a full system backup.

Note: If you plan on partitioning an eServer™ iSeries model with a Hardware Management Console for eServer (HMC), see the logical partitioning information on the IBM Systems Hardware Information Center.

Logical partitions can be created using iSeries Navigator. In order to access logical partition functions, you must first configure the service tools server. For more information about the service tools server, see Configure the service tools server.

You will need to use a service tools user ID with LPAR administrator authority.

Depending on the number of secondary partitions you plan to create, the primary partition's memory requirements might increase. If you have allocated minimum memory resources to your primary partition for its maximum memory configuration, you must add 8MB of memory to the minimum memory size of the primary partition before you create secondary partitions on your server. This increase is due to internal processing required to support the new partition.

If you do not have enough minimum memory to start the Primary partition, you might receive system reference code (SRC) 1 B600 5390. To increase the minimum memory for the Primary partition, you must reconfigure the Primary partition's memory. In the character-based interface, the system will provide

suggested memory minimums in the partition configuration display screen. When creating a partition using iSeries Navigator, iSeries Navigator will check the memory requirements and prompt you to fix them before restarting the system.

Attention: It is strongly recommended that you print the system configuration for all of your I/O resources that are allocated to all of the logical partitions, when your setup is complete.

If you have already added your server to the Systems with Partitions folder and you want to create a new logical partition on your system, follow these step:

To create a new logical partition using My Connections, follow these steps:

1. In iSeries Navigator, expand **My Connections** or your active environment.
2. Select the primary partition of the system.
3. Expand **Configuration and Service** and select **Logical Partitions**.
4. Right-click the physical system and select **Configure Partitions**. You are now working in the Configure Logical Partitions window.
5. Right-click the **Physical System** and select **New Logical Partitions** to start the wizard.

To create a new logical partition using the service tools window, follow these steps:

1. In iSeries Navigator, select **My Connections** or your active environment.
2. Select **Open iSeries Navigator service tools window** in the Taskpad window. If the Taskpad window is not displayed, select **View** and select **Taskpad**.
3. Enter the **IP address** of the service tool network interface to which you want to connect. Click **OK**.
4. You will be prompted for your **Service Tools User ID and password**.
5. Right-click **Logical Partitions** and select **Configure Partitions**. You are now working in the Configure Logical Partitions window.
6. Right-click the **Physical System** and select **New Logical Partitions** to start the wizard.

If this is the first time you are using iSeries Navigator to create a logical partition on this system, you first need to add your system to the Systems with Partitions folder using the following steps:

1. In iSeries Navigator, expand **Management Central**.
2. Right-click **Systems with Partitions** and select **Add System**. You must provide an IP address or system name of the system's primary partition you want to add.
3. The **Service Device Sign-on** window will ask for a service tool user ID and password.
4. Click **Finish** on the **Add System** panel.

When the system is added, follow these steps to use Management Central:

1. In iSeries Navigator, expand **Management Central**.
2. Expand **Systems with Partitions**.
3. Select the physical system where you want to create a new logical partition.
4. Right-click the physical system and select **Configure Partitions**. You are now working in the Configure Logical Partitions window.
5. Right-click the **Physical System** and select **New Logical Partitions** to start the wizard.

You will find detailed instructions and explanations in iSeries Navigator help topics.

Related concepts

"Plan for logical partitions" on page 40

Understand the hardware and software requirements needed to successfully implement logical partitions. Read and go through the preorder tasks of completing the planning work sheet.

Related tasks

“Logical partition authority” on page 64

The authorities that you grant to service tool users determines what logical partition information they can access and what tasks they can perform. Care should be exercised in assigning service tool user profile privileges to manage partition security.

Manage logical partitions

Find all the information you need to manage your logical partitions. Access your logical partition information, and find instructions on restarting and powering down individual logical partitions. Also, use the information to change your logical partition configuration, manage security, and change processing resources.

When you create one or more logical partitions on the iSeries server, you are creating partitions that are independent of each other. Each logical partition has its own independent configuration of processor, memory, input/output (I/O) devices, Licensed Internal Code, Operating System (i5/OS), and optional software applications.

You can use iSeries Navigator to manage your logical partitions. Most tasks you perform are independent to the other logical partitions on the system. You should approach each logical partition as independent systems.

Refer to Backup and recovery for information on backing up your system. Basic system operations is another source that provides additional information about starting and managing your system.

For more information on understanding the basic steps to installing a fix (or Program Temporary Fix, PTF) using Management Central, see Install a fix on a system with logical partitions

Related concepts

“Logical partition concepts” on page 2

Use this information to get the technical facts about logical partitions to find out what you need to know about your hardware, and to discover the multiple uses you can get from logical partitions.

Manage logical partitions by using iSeries Navigator, DST, and SST

Understand how to manage logical partitions with iSeries Navigator along with DST and SST. Determine the authority needed to perform logical partition tasks.

On a system without logical partitions, you can use the control panel to perform many tasks. However, for systems with logical partitions, secondary partitions do not have physical control panels. To control your secondary partitions you can use the remote control panel graphical user interface (GUI).

For more information on how to use the remote control panel for logical partitions, refer to Access control panel functions .

Security considerations

Users wishing to access logical partition information in iSeries Navigator, Dedicated Service Tools (DST), and System Service Tools (SST) will require either operations or administration authority to the logical partition function. In addition, users wishing to utilize the Operations Console remote panel for secondary partitions from their PC will require remote panel authorization.

Care should be taken in administering the appropriate service tool authority for partition control. See Service tools user IDs for more information about administering service tool security.

iSeries Navigator

iSeries Navigator is a graphical user interface used to configure, monitor, and manage the iSeries server. iSeries Navigator comes packaged with iSeries Access for Windows® and does not require a iSeries Access license to use.

iSeries Navigator contains a graphical wizard you can use to help you create logical partitions, easily configure and manage logical partitions; dynamically move processors, memory, interactive performance, and some I/O processors; and shared processors with the new shared processor pool. In addition, you will also be able to enable or disable virtual OptiConnect, virtual ethernet, and HSL OptiConnect; or change the status of the system bus to dedicated or shared mode without requiring a system restart. With each logical partition function, iSeries Navigator provides you with detailed help text that corresponds with each task. Refer to iSeries Navigator for more information.

iSeries Navigator versus DST/SST Functions

There are some logical partitions functions that still require you to use DST or SST through a character-based interface display. For example, some logical partition recovery actions and printing system configurations tasks are accessible through DST and SST functions only. However, since SST is easier to access than DST, we recommend that you use SST whenever possible to access these tasks.

To start SST or DST on a character-based interface display, go to Start SST and DST.

The following table describes the capabilities that are available to logical partitions using iSeries Navigator or DST and SST.

Table 9. Capabilities available to logical partitions using iSeries Navigator or DST and SST

Function	iSeries Navigator	DST and SST
Accept a disk unit as load source for a logical partition		X
Change a bus ownership type	X	X
Change a default electronic customer support resource	X	X
Change a partition name	X	X
Change communication options	X	X
Change I/O configuration of primary and secondary partitions	X	X
Change operating mode for a logical partition	X	X
Change the alternate restart device	X	X
Change the guest partition host information	X	X
Change the partition type	X	X
Change the restart source command line parameters of a guest partition	X	X
Change the restart (or IPL) source for a logical partition	X	X
Clear nonreporting resources on logical partitions	X	X
Clear partition configuration data for logical partitions	X	X

Table 9. Capabilities available to logical partitions using iSeries Navigator or DST and SST (continued)

Function	iSeries Navigator	DST and SST
Clear partition configuration from nonconfigured disk units		X
Create a new i5/OS logical partition	X	X
Create a guest partition	X	X
Copy partition configuration data between IPL sources		X
Delete a logical partition	X	X
Delete all logical partition configuration data	X	X
Display available hardware resources	X	X
Display system resources	X	X
Display the communication options of a logical partition	X	X
Display the console for a partition	X	X
Display the logical partition operating system release level	X	X
Display the operating system type for a partition	X	X
Display the partition ID	X	X
Display the PCI information	X	X
Display the remote control panel for a logical partition	X	X
Display the system reference code history for a primary partition.	X	
Display the system reference code history for secondary partitions	X	X
Dynamic movement of interactive performance	X	X
Dynamic movement of I/O processors	X	X
Dynamic movement of memory	X	X
Dynamic movement of processors	X	X
Enable High-Speed link (HSL) OptiConnect	X	X
Enable virtual Ethernet communication	X	X
Enable virtual OptiConnect communication	X	X
Find a logical address for a resource	X	X
Move a dedicated processor	X	X
Move a dedicated processor to the shared processor pool	X	X
Move an I/O processor	X	X
Move interactive performance, memory or shared processing power	X	X

Table 9. Capabilities available to logical partitions using iSeries Navigator or DST and SST (continued)

Function	iSeries Navigator	DST and SST
Move an IOA assigned to an IOP to a guest partition	X	X
Move an IOA to a guest partition	X	X
Move an IOA assigned to an i5/OS partition	X	X
Perform main storage dumps on servers with logical partitions	X	X
Prevent a secondary logical partition from restarting during a system restart	X	X
Print system configuration for logical partitions		X
Recover logical partition configuration data	X	X
Reset a disk unit I/O processor with logical partitions		X
Restart a secondary logical partition during a system restart		X
Restart a system with logical partitions	X	X
Restore all logical partition configuration data	X	
Save all logical partition configuration data	X	
Schedule a dedicated processor move	X	
Schedule an interactive performance move	X	
Schedule an I/O processor move	X	
Schedule a memory move	X	
Schedule a shared processor move	X	
Update configuration data	X	X
Use remote service with logical partitions	X	X
View the status of a logical partition	X	X

Related tasks

“Logical partition authority” on page 64

The authorities that you grant to service tool users determines what logical partition information they can access and what tasks they can perform. Care should be exercised in assigning service tool user profile privileges to manage partition security.

“Start SST and DST for logical partitions” on page 62

Look here for information about starting SST and DST on primary and secondary partitions.

Start iSeries Navigator:

iSeries Navigator is included as part of iSeries Access for Windows.

To make sure your PC meets iSeries Navigator requirements, refer to hardware and software requirements. For more information on installing iSeries Navigator to your PC, refer to iSeries Navigator.

Along with iSeries Navigator, you may want to install Operations Console of iSeries Access. Operations console allows you to use a directly cabled, LAN-attached or remote PC to access and control an iSeries console and the remote control panel for logical partitions.

You can start iSeries Navigator by double-clicking the iSeries Navigator icon on your Windows desktop. When you are asked if you want to create an iSeries connection, click **Yes** and follow the instructions in the Connection wizard. You must have operation or administration authority to use iSeries Navigator.

Start SST and DST for logical partitions:

Look here for information about starting SST and DST on primary and secondary partitions.

Starting SST on the primary partition or a secondary partition

You must configure Service Tools user IDs before starting SST or DST. For more information on how to configure user ID, refer to logical partition authority.

You can start System Service Tools (SST) by typing the start system service tools (STRSST) command and pressing Enter at an i5/OS command line. You can start SST on any primary or secondary partition workstation.

Related concepts

“Manage logical partitions by using iSeries Navigator, DST, and SST” on page 58
Understand how to manage logical partitions with iSeries Navigator along with DST and SST.
Determine the authority needed to perform logical partition tasks.

“Change the operating mode for a logical partition” on page 88
The operating mode for logical partitions works just like operating mode on a system without logical partitions.

Related tasks

“Logical partition authority” on page 64
The authorities that you grant to service tool users determines what logical partition information they can access and what tasks they can perform. Care should be exercised in assigning service tool user profile privileges to manage partition security.

“Restart a system with logical partitions” on page 87
To restart the whole system (perform a power down and an initial program load (IPL)) the secondary partitions must power down with the primary partition.

Starting DST on the primary partition:

When you start Dedicated Service Tools (DST), make sure that the primary partition console is at a sign on display to prevent jobs from ending abnormally. As an alternative, you can perform the following steps on the logical partition. You only need to perform these steps once since the system maintains changes across initial program loads (IPLs):

1. In iSeries Navigator, expand **My Connection**.
2. Select the physical system with which you want to work.
3. Expand **Configuration and Service** and select **System Values**.
4. Select **Devices** and the **Recovery** tab.
5. Select **End the job and send message to QHST log (ENDJOBNO LIST)** and deselect the box or to select **End the job and send message to QHST log (ENDJOB)** select the box.

Complete Time Out Interval (QDSCJOBITV):

To complete a **Time Out Interval** (QDSCJOBITV) follow these steps:

1. In iSeries Navigator, expand **My Connection**.
2. Select the physical system with which you want to work.
3. Expand **Configuration and Service** and select **System Values**.
4. Select **Jobs** and the **Interactive Jobs** tab.
5. Select **Disconnect Jobs** and set the system value to 5 minutes.

For more information on how to use system values in iSeries Navigator, refer to i5/OS system values.

To start DST on the primary partition use the control panel to put the system in manual mode and select option 21. The system will prompt you for a user ID and password. For more information on obtaining an ID and password, refer to Configure service tools user IDs.

Starting DST on a secondary partition from DST on the primary partition:

Follow these steps to start DST on a secondary partition:

1. Start DST on the primary partition.
2. Select option 11 (Work with system partitions).
3. Select option 2 (Work with partition status).
4. Use your cursor to select the secondary partition for which you want DST.
5. Select option 10 (Mode manual) if the secondary partition is not already in manual mode.
6. Press F23 for more options.
7. Select option 21 (Force Dedicated Service Tools). The secondary partition console will experience a device I/O error and end abnormally. This is normal.
8. The DST display will appear on the workstation that is acting as console for the secondary partition. Sign on to DST.
9. Before you leave DST, set the secondary partition back to normal mode if you want the next IPL to be unattended.

Forcing DST from SST:

You can force DST to start from SST if the logical partition is not in secure mode. On the primary partition, you can force DST for itself or any of the secondary partitions. On a secondary partition you can force DST to start on itself.

When you force DST from the system control panel of the Work with Partition Status display, you cancel the current job on the partition console.

Attention: If you perform an IPL on the logical partition before you exit DST, the next IPL will be abnormal. To avoid an abnormal IPL, exit DST before you perform the IPL. Then sign on to that logical partition and perform the IPL.

These steps affect how the system stops active jobs when you start DST, including the system partition's service function. You may need to wait five minutes before starting service functions in DST that were active in SST when you entered option 21.

To force DST from SST follow these steps:

1. Use the STRSST command to start SST.
2. Select option 5 (Work with system partitions).
3. Select option 2 (Work with partition status).
4. Use the cursor to select the logical partition on which you want DST.

5. If the partition is not in manual mode, select option 10 (Mode manual).
6. Select option 21 (Force DST). If you are forcing DST from the logical partition workstation where you want DST, the workstation will experience a device I/O error and end abnormally. This is normal.
7. Sign on to DST.
8. Before you exit DST, set the logical partition back to normal mode if you want the next IPL to be unattended.

Logical partition authority:

The authorities that you grant to service tool users determines what logical partition information they can access and what tasks they can perform. Care should be exercised in assigning service tool user profile privileges to manage partition security.

Two service tool functional privileges relate to logical partitions. These privileges support basic operations or advanced administration.

To grant a user logical partition **operations** authority perform the following steps:

1. Start DST as QSECOFR or with any other user ID with Service tool security privilege.
2. Select option 5 (Work with DST environment).
3. Select option 3 (Service tools user profiles).
4. Select option 1 (Create) to create a new user profile or option 7 (Change attributes) to adjust an existing user.
5. Ensure that the **System partitions-operations** privilege is granted.

To grant a user logical partition **administration** authority (which enables all operation task as well), perform the following steps:

1. Start DST as QSECOFR or with any other user ID with Service tool security privilege.
2. Select option 5 (Work with DST environment).
3. Select option 3 (Service tools user profiles).
4. Select option 1 (Create) to create a new user profile or option 7 (Change attributes) to adjust an existing user.
5. Ensure that the **System partitions-administration** privilege is granted.

The following table describes which authority is required to complete a logical partition task:

Table 10. Authority required to complete a logical partition task

Function	Administration authority	Operation authority
Accept a disk unit as load source for a logical partition	X	
Change a bus ownership type	X	
Change a default electronic customer support resource	X	X
Change a partition name	X	X
Change communication options with resources in use (forced)	X	
Change communication options with resources not in use	X	X
Change I/O configuration of primary and secondary partitions	X	X

Table 10. Authority required to complete a logical partition task (continued)

Function	Administration authority	Operation authority
Change operating mode for a logical partition	X	X
Change the alternate restart device for a logical partition	X	X
Change the guest partition host information	X	X
Change the partition type	X	
Change the restart source command line parameters of a guest partition	X	X
Change the load source for a logical partition	X	X
Clear nonreporting resources on logical partitions	X	
Clear partition configuration from nonconfigured disk units	X	
Copy partition configuration data between load sources	X	
Create a new logical partition	X	
Create a guest partition	X	
Delete a logical partition	X	
Delete all logical partition configuration data	X	
Display available hardware resources	X	X
Display the communication options of a logical partition	X	X
Display the console for a partition	X	X
Display the logical partition operating system release level	X	X
Display the operating system type for a partition	X	X
Display the partition ID	X	X
Display the PCI information	X	X
Display the remote control panel for a logical partition	X	X
Display the system reference code history for logical partitions	X	X
Display system resources	X	X
Dynamic movement of interactive performance	X	X
Dynamic movement of I/O processors	X	X
Dynamic movement of memory	X	X
Dynamic movement of processors	X	X
Enable the virtual ethernet communication for a logical partition	X	X

Table 10. Authority required to complete a logical partition task (continued)

Function	Administration authority	Operation authority
Find a logical address for a resource	X	X
Move a dedicated processor	X	X
Move a dedicated processor to the shared processor pool	X	X
Move an I/O processor with resources in use (forced)	X	X
Move an I/O processor with resources not in use	X	X
Move interactive performance, memory or shared processing power	X	X
Move an I/O adapter assigned to an I/O processor to a guest partition	X	X
Move an I/O adapter to a guest partition	X	X
Move an I/O adapter assigned to an i5/OS partition	X	X
Perform main storage dumps on servers with logical partitions	X	X
Prevent a secondary logical partition from restarting during a system restart	X	X
Print system configuration for logical partitions	X	X
Recover logical partition configuration data	X	
Reset a disk unit I/O processor with logical partitions	X	X
Restart a secondary logical partition during a system restart		X
Restart a system with logical partitions	X	X
Restore all logical partition configuration data	X	X
Save all logical partition configuration data	X	X
Schedule a dedicated processor move	X	X
Schedule an interactive performance move	X	X
Schedule an I/O processor move	X	X
Schedule a memory move	X	X
Schedule a shared processor move	X	X
Update partition configuration data on all logical partitions	X	
Use remote service with logical partitions	X	X
View the status of a logical partition	X	X

To use an **Operations Console remote panel** across the LAN, a PC needs a device profile in the primary partition with the **Partition remote panel XXXXXXXX nnn** attribute where XXXXXXXX is the target partition name and nnn is the numeric partition identifier. To grant a user the ability to use the remote panel, perform the following steps:

1. Start DST as QSECOFR or with any other user ID with Service tool security privilege.
2. Select option 5 (Work with DST environment).
3. Select option 5 (Service tools device profiles).
4. Select option 1 (Create) to create a new device profile or option 7 (Change attributes) to adjust an existing device.
5. Ensure that the **Partition remote panel** attribute for the appropriate partition is granted.

This device profile enables panel functions from the remote console graphical user interface on the PC. All users will require a valid service tool user profile. For most functions, no special privilege is required to use the panel. However, to change the panel key position (Manual, Normal, Auto, or Secure), the user will require a service tool user profile in the primary partition with the

Partition remote panel key XXXXXXXX nnn where XXXXXXXX

is the target partition name and nnn is the numeric partition identifier. To grant a user the ability to change the key, perform the following steps:

1. Start DST as QSECOFR or with any other user ID with Service tool security privilege.
2. Select option 5 (Work with DST environment).
3. Select option 3 (Service tools user profiles).
4. Select option 1 (Create) to create a new user profile or option 7 (Change attributes) to adjust an existing user.
5. Ensure that the **Partition remote panel key** privilege for the appropriate partition is granted.

For additional information on service tool user IDs, refer to Service tools user IDs.

Related concepts

“Manage logical partitions by using iSeries Navigator, DST, and SST” on page 58
Understand how to manage logical partitions with iSeries Navigator along with DST and SST.
Determine the authority needed to perform logical partition tasks.

“Manage security for logical partitions”

Understand who has authority to perform logical partition tasks and how to restrict access to the system.

Related tasks

“Create logical partitions” on page 56

Find information about the iSeries Navigator wizard that guides you through the process of creating logical partitions on your server.

“Start SST and DST for logical partitions” on page 62

Look here for information about starting SST and DST on primary and secondary partitions.

Manage security for logical partitions

Understand who has authority to perform logical partition tasks and how to restrict access to the system.

Most security related tasks you perform on a partitioned system are the same as on a system without logical partitions. However, when you create logical partitions, you work with more than one independent system. Therefore you will have to perform the same tasks on each logical partition instead of just once on a system without logical partitions.

Here are some basic rules to remember when dealing with security on logical partitions:

- You must first configure the service tools server in order to access the iSeries Navigator logical partition functions. For more information on the service tools server, refer to *Configure the service tools server* .
- Users performing logical partition operation or administration authority will require a Service Tool user profile in the primary partition.
- You add users to the system one logical partition at a time. You need to add your users to each logical partition you want them to access.
- Partitions cannot see or use memory and disk units of another logical partition.
- Partitions can only see their own hardware resources.
- The iSeries Navigator logical partition function can see all system hardware resources in the *Configure Partitions* window by selecting *All hardware* when used from the primary partition. When used from secondary partitions, only the resources assigned to the partition are viewable. In either partition, users require logical partition operation or administration authority to view information.
- The system control panel controls the primary partition. The remote control panel controls all partitions on the server. When any partition is set to secure, no actions can be performed from either the system panel, the remote control panel, or the *Work with Partitions Status* display from SST. To force DST from the system control panel or the remote control panel, you must change the mode to *Manual*.
 - You can use the remote control panel to power on and power off the partition.
 - You can use the remote control panel to set the secondary partition mode from secure to any other value.

Once a secondary partition's mode is no longer secure, you can use the remote control panel to change the partition status.

For more information on security on your iSeries server, refer to *iSeries Security-Reference*  and *Plan and set up system security* for additional information on security.

Related concepts

“System reference codes (SRCs) for logical partitions” on page 92
Find a list that contains the common SRCs that the PAL can report.

“Enforce security in secondary partitions” on page 54
Secondary partitions act as independent servers on your iSeries.

Related tasks

“Logical partition authority” on page 64
The authorities that you grant to service tool users determines what logical partition information they can access and what tasks they can perform. Care should be exercised in assigning service tool user profile privileges to manage partition security.

Print system configuration for logical partitions

Use DST or SST to print copies of your system hardware configuration.

It is strongly recommended that you print the system configuration for all of your I/O resources that are allocated to all of the logical partitions, when your set up is complete. Logical partition configuration information is not saved during the save process, and therefore a printout will be required to allocate appropriate resources should you have to recover your system in a disaster recovery scenario.

You will also need to print the system configuration report for all logical partitions should you need to perform an MES (Miscellaneous Equipment Specification) also known as hardware upgrade to your system with logical partitions. This information will assist your IBM Business Partner or IBM Marketing Representative to understand how your system I/O resources are assigned to the logical partitions.

Attention: Printing a system configuration list through Hardware Service Manager within SST will only provide you with a configuration listing of the resources that are allocated to that specific partition. This report will not provide you with details for the entire system. For this reason, you should use the steps outlined below using the primary partition.

Follow these steps to print the system configuration:

1. From the primary partition start SST or DST.
2. From SST select option 5 (Work with system partitions); from DST select option 11 (Work with system partitions) and press **Enter**.
3. Select option 1 (Display partition information) and press F6 to get all the following information. Or you can proceed to the next steps.
4. Select option 5 (Display system I/O resources).
5. At the Level of detail to display field, type *ALL to set the level of detail to ALL.
6. Press F6 to print the system I/O configuration.
7. Select option 1 and press Enter to print to a spooled file.
8. Press F12 to return to the Display Partition Information display.
9. Select option 2 (Display partition processing configuration).
10. Press F6 to print the processing configuration.
11. Press F12 to return to Display Partition Information display.
12. Select option 7 (Display communications options).
13. Press F11, then press F6 to print communication configuration.
14. Select option 1 and press **Enter** to print to a spooled file.
15. Return to an i5/OS command line and print these three spooled files.

Dynamically move logical partition resources

Understand how to move processors, I/O processors, memory, and interactive performance between partitions without requiring a partition or system restart.

Dynamic movement of resources provides users the ability to move processors, memory, and interactive performance between partitions without requiring a partition or system restart. To take full advantage of this enhancement your primary and secondary partitions must be running V5R1 or V5R2.

Dynamically move interactive performance:

You can set up interactive performance so that you can change the values between logical partitions without needing to restart the entire system.

The minimum and maximum specify the range of values you can enter without needing to restart the partition. When you change the limits for the logical partition's interactive performance, you must restart the partition.

You can specify an interactive performance minimum value equal to the minimum amount of interactive performance needed to support the logical partition. The maximum value must be less than the amount of interactive performance available on the system.

Your system has a certain amount of interactive performance based on the type of system and the number of processors. Interactive performance refers to how much the user must interact with (respond to prompts from) the computer. You can contrast interactive with batch (no user intervention required).

Given the amount of interactive performance on your system (CPW), you need to determine what percentage will be available for each logical partition. The combined total of each logical partition's interactive performance must not exceed 100%.

To move interactive performance from one logical partition to another partition using My Connections, follow these steps:

1. In iSeries Navigator, expand **My Connections** or your active environment.
2. Select the primary partition of the system.
3. Expand **Configuration and Service** and select **Logical Partitions**.
4. Right-click the **Logical Partition** and select **Configure Partitions**. You are now working in the Configure Logical Partitions window.
5. Select the partition from which you would like to move interactive performance.
6. Right-click **Interactive Performance** and select **Move**.
7. Specify the amount of interactive performance to move in **Amount to Move**. This value must be less than the current amount of interactive performance available to the logical partition. The **After Move** values for both the source and receiving partitions must fall within the minimum/maximum ranges specified for interactive performance for both of the partitions.
8. Select the partition to receive the interactive performance in **Move to -- Logical Partition**.
9. Click **OK** to move the amount of interactive performance you specified.

To move interactive performance from one logical partition to another partition using the service tools window, follow these steps:

1. In iSeries Navigator, select **My Connections** or your active environment.
2. Select **Open iSeries Navigator service tools window** in the Taskpad window. If the Taskpad window is not displayed, select **View** and select **Taskpad**.
3. Enter the **IP address** of the service tool network interface to which you want to connect. Click **OK**.
4. You will be prompted for your **Service Tools User ID and password**.
5. Expand the system name select **Logical Partitions**.
6. Right-click the logical partition and select **Configure Partitions**. You are now working in the Configure Logical Partitions window.
7. Select the partition from which you would like to move interactive performance.
8. Right-click **Interactive Performance** and select **Move**.
9. Specify the amount of interactive performance to move in **Amount to Move**. This value must be less than the current amount of interactive performance available to the logical partition. The **After Move** values for both the source and receiving partitions must fall within the minimum/maximum ranges specified for interactive performance for both of the partitions.
10. Select the partition to receive the interactive performance in **Move to -- Logical Partition**.
11. Click **OK** to move the amount of interactive performance you specified.

To move interactive performance from one logical partition to another using Management Central, follow these steps:

1. In iSeries Navigator, expand **Management Central**.
2. Expand **Systems with Partitions**.
3. Select the physical system that has the logical partition with which you want to work.
4. Right-click the logical partition and select **Configure Partitions**. You are now working in the Configure Logical Partitions window.
5. Select the partition from which you would like to move interactive performance.
6. Right-click **Interactive Performance** and select **Move**.
7. Specify the amount of interactive performance to move in **Amount to Move**. This value must be less than the current amount of interactive performance available to the logical partition. The **After Move** values for both the source and receiving partitions must fall within the minimum/maximum ranges specified for interactive performance for both of the partitions.
8. Select the partition to receive the interactive performance in **Move to -- Logical Partition**.

9. Click **OK** to move the amount of interactive performance you specified.

Related concepts

“Restart and power down a system with logical partitions” on page 84
Understand how to safely restart and power down a system with logical partitions.

Dynamically move an I/O processor:

A logical partition controls all devices connected to an IOP.

You cannot switch one I/O device to another logical partition without moving the ownership of IOP. On a shared bus, you can move IOPs from a logical partition without restarting the server.

All resources (IOAs and devices) that are attached to the IOP cannot be in use when you move an IOP from a logical partition.

To move an I/O processor from one logical partition to another partition using My Connections, follow these steps:

1. Ensure that any devices attached to the I/O processor you want to move are not busy. The devices should be varied off and listed as unavailable hardware.
2. In iSeries Navigator, expand **My Connections** or your active environment.
3. Select the primary partition of the system.
4. Expand **Configuration and Service** and select **Logical Partitions**.
5. Right-click the **Logical Partition** and select **Configure Partitions**. You are now working in the Configure Logical Partitions window.
6. Select the partition that has the I/O processor you would like to move.
7. Right-click the I/O processor you want move, and select **Move**.

To move an I/O processor from one logical partition to another partition using the service tools window, follow these steps:

1. Ensure that any devices attached to the I/O processor you want to move are not busy. The devices should be varied off and listed as unavailable hardware.
2. In iSeries Navigator, select **My Connections** or your active environment.
3. Select **Open iSeries Navigator service tools window** in the Taskpad window. If the Taskpad window is not displayed, select **View** and select **Taskpad**.
4. Enter the **IP address** of the service tool network interface to which you want to connect. Click **OK**.
5. You will be prompted for your **Service Tools User ID and user password**.
6. Expand the system name select **Logical Partitions**.
7. Right-click the logical partition and select **Configure Partitions**. You are now working in the Configure Logical Partitions window.
8. Select the partition that has the I/O processor you would like to move.
9. Right-click the I/O processor you want move, and select **Move**.

To move an I/O processor from one logical partition to another using Management Central, follow these steps:

1. Ensure that any devices attached to the I/O processor you want to move are not busy. The devices should be varied off and listed as unavailable hardware.
2. In iSeries Navigator, expand **Management Central**.
3. Expand **Systems with Partitions**.
4. Select the physical system that has the logical partition with which you want to work.

5. Right-click the logical partition and select **Configure Partitions** . You are now working in the Configure Logical Partitions window.
6. Select the partition that has the I/O processor you would like to move.
7. Right-click the I/O processor you want move, and select **Move**.

Change the ownership of a bus:

A logical partition can own a system input/output (I/O) bus one of two ways, own bus dedicated, and own bus shared.

When a logical partition owns a bus with own bus dedicated status, no other logical partition can share it.

If a logical partition owns a bus with the status of own bus shared, the partition can share the bus with another logical partition. However, that other logical partition must add that bus with the status of use bus shared.

Before you change a bus ownership type to own bus dedicated, you must first add all of the resources under that bus to that partition. When you change a bus' ownership type to own bus shared, resources under that bus can now be removed. Other logical partitions (primary partition and all secondary partitions) can now use these resources.

To change the ownership for a bus using My Connections, follow these steps:

1. In iSeries Navigator, expand **My Connections** or your active environment.
2. Select the primary partition of the system.
3. Expand **Configuration and Service** and select **Logical Partitions**.
4. Right-click the **Logical Partition** and select **Configure Partitions**. You are now working in the Configure Logical Partitions window.
5. Right-click the bus for which you want to change ownership and select **Properties**.
6. Select the **Partitions** page.
7. Select the partition that owns the bus in **Owning logical partition**, and then select the ownership type in **Sharing**. If the ownership type is shared, the partitions that share the bus appear in the list. Click **Help** if you need more information on these options.
8. Click **OK**.

Dynamically move memory:

Memory in each logical partition operates within its assigned minimum and maximum values.

You can dynamically move memory between logical partitions without needing to restart the affected partitions as long as your request for memory movement is within the range of the minimum and maximum values specified during partition creation.

When you request to dynamically move memory between partitions, you should note that this memory is removed and added to the base memory pool of each of the partitions (*BASE pool). Private memory pools or shared memory pools are not affected. If the move request exceeds the amount of memory available in the base pool, the system will only free up excess memory pages after keeping the minimum amount of memory required in the base pool. This value is determined by the base storage minimum size (QBASPOOL) system value. To prevent any data loss during memory movement, the system first writes any data from memory pages to the disks before making the memory pages available to another partition. Depending on the amount of memory you have requested to move, this may take some time.

Each partition will report its runtime minimum memory size. This value is an estimate of how much memory in the partition is locked into that partition and cannot be moved dynamically. Reducing the number of processes or threads within a partition or changing the *BASE pool will affect the runtime minimum.

The full amount of memory that you assign to a logical partition may not be available for the partition's use. Static memory overhead required to support the assigned maximum memory will affect the reserved or hidden memory amount. This static memory overhead will also influence the minimum memory size of a partition.

The minimum memory size assigned to a partition can be changed with only a restart of the partition. However, changes to the maximum memory size require a restart of the entire system and may require a larger minimum memory value.

To move memory from one logical partition to another using My Connections, follow these steps:

1. In iSeries Navigator, expand **My Connections** or your active environment.
2. Select the primary partition of the system.
3. Expand **Configuration and Service** and select **Logical Partitions**.
4. Right-click the **Logical Partition** and select **Configure Partitions**. You are now working in the Configure Logical Partitions window.
5. Select the partition from which you would like to move memory.
6. Right-click **Memory** and select **Move**.
7. Specify the amount of memory to move in **Memory to move**. This value must be less than the current amount of memory available to the logical partition. The **Memory after Move** values for both the source and receiving partitions must fall within the minimum/maximum ranges specified for memory.
8. Select the partition to receive the memory in **To logical partition**.
9. Click **OK** to move the memory you specified.

To move memory from one logical partition to another using the service tools window, follow these steps:

1. In iSeries Navigator, select **My Connections** or your active environment.
2. Select **Open iSeries Navigator service tools window** in the Taskpad window. If the Taskpad window is not displayed, select **View** and select **Taskpad**.
3. Enter the **IP address** of the service tool network interface to which you want to connect. Click **OK**.
4. You will be prompted for your **Service Tools User ID and password**.
5. Expand the system name select **Logical Partitions**.
6. Right-click the logical partition and select **Configure Partitions**. You are now working in the Configure Logical Partitions window.
7. Select the partition from which you would like to move memory.
8. Right-click **Memory** and select **Move**.
9. Specify the amount of memory to move in **Memory to move**. This value must be less than the current amount of memory available to the logical partition. The **Memory after Move** values for both the source and receiving partitions must fall within the minimum/maximum ranges specified for memory.
10. Select the partition to receive the memory in **To logical partition**.
11. Click **OK** to move the memory you specified.

To move memory from one logical partition to another using Management Central, follow these steps:

1. In iSeries Navigator, expand **Management Central**.
2. Expand **Systems with Partitions**.

3. Select the physical system that has the logical partition with which you want to work.
4. Right-click the logical partition and select **Configure Partitions**. You are now working in the Configure Logical Partitions window.
5. Select the partition from which you would like to move memory.
6. Right-click **Memory** and select **Move**.
7. Specify the amount of memory to move in **Memory to move**. This value must be less than the current amount of memory available to the logical partition. The **Memory after Move** values for both the source and receiving partitions must fall within the minimum/maximum ranges specified for memory.
8. Select the partition to receive the memory in **To logical partition**.
9. Click **OK** to move the memory you specified.

Related concepts

“Determine the amount of memory to move” on page 45

Primary partitions need a minimum of 256 MB of memory.

“Restart and power down a system with logical partitions” on page 84

Understand how to safely restart and power down a system with logical partitions.

Dynamically move processing power:

The ability to move processor power dynamically becomes important when you need to adjust to changing workloads.

Processors have minimum and maximum values associated with them. These values enable you to establish a range within which you can dynamically move the resource without needing to restart the logical partition. Minimum values dictate what is required to restart the partition. A minimum value of zero is valid. A partition with zero processors or processing units is not functional.

For both shared and dedicated processors you can specify a minimum value equal to the minimum amount of processing power needed to support the logical partition. The maximum value must be less than the amount of processing power available on the system. If you change either the minimum or maximum value, it will require you to restart the entire partition. If the minimum value is not met for all logical partitions, only the primary will restart.

Note for Partitions Not Using DB2 UDB Symmetric Multiprocessing (SMP): Changing processor resources dynamically does not affect the number of tasks used to rebuild database access paths. To apply the processor resource change to database access paths, you need to restart the partition. If you have SMP enabled, no restart is required.

To move a dedicated processor from one logical partition to another partition using My Connections, follow these steps:

1. In iSeries Navigator, expand **My Connections** or your active environment.
2. Select the primary partition of the system.
3. Expand **Configuration and Service** and select **Logical Partitions**.
4. Right-click the **Logical Partition** and select **Configure Partitions**. You are now working in the Configure Logical Partitions window.
5. Select the partition from which you would like to move dedicated processors.
6. Right-click **Dedicated Processors** and select **Move**.
7. Specify the number of dedicated processors to move in **Amount to move**. This value must be less than the number of processors the logical partition currently has. The **Amount after move** values for both the source and receiving partitions must fall within the minimum/maximum ranges specified for dedicated processors. Also, any logical partition that is using dedicated processors, must have at least 1 dedicated processor.

8. Select the partition to receive the dedicated processors in **Move to -- Logical partition**
9. Click **OK** to move the dedicated processors you specified.

To move a dedicated processor from one logical partition to another partition using the service tools window, follow these steps:

1. In iSeries Navigator, select **My Connections** or your active environment.
2. Select **Open iSeries Navigator service tools window** in the Taskpad window. If the Taskpad window is not displayed, select **View** and select **Taskpad**.
3. Enter the **IP address** of the service tool network interface to which you want to connect. Click **OK**.
4. You will be prompted for your **Service Tools User ID and user password**.
5. Expand the system name select **Logical Partitions**.
6. Right-click the logical partition and select **Configure Partitions**. You are now working in the Configure Logical Partitions window.
7. Select the partition from which you would like to move dedicated processors.
8. Right-click **Dedicated Processors** and select **Move**.
9. Specify the number of dedicated processors to move in **Amount to move**. This value must be less than the number of processors the logical partition currently has. The **Amount after move** values for both the source and receiving partitions must fall within the minimum/maximum ranges specified for dedicated processors. Also, any logical partition that is using dedicated processors, must have at least 1 dedicated processor.
10. Select the partition to receive the dedicated processors in **Move to -- Logical partition**
11. Click **OK** to move the dedicated processors you specified.

To move a dedicated processor from one logical partition to another using Management Central, follow these steps:

1. In iSeries Navigator, expand **Management Central**.
2. Expand **Systems with Partitions**.
3. Select the physical system that has the logical partition with which you want to work.
4. Right-click the logical partition and select **Configure Partitions**. You are now working in the Configure Logical Partitions window.
5. Select the partition from which you would like to move dedicated processors.
6. Right-click **Dedicated Processors** and select **Move**.
7. Specify the number of dedicated processors to move in **Amount to move**. This value must be less than the number of processors the logical partition currently has. The **Amount after move** values for both the source and receiving partitions must fall within the minimum/maximum ranges specified for dedicated processors. Also, any logical partition that is using dedicated processors, must have at least 1 dedicated processor.
8. Select the partition to receive the dedicated processors in **Move to -- Logical partition**
9. Click **OK** to move the dedicated processors you specified.

To move shared processing power from one logical partition to another using My Connections, follow these steps:

1. In iSeries Navigator, expand **My Connections** or your active environment.
2. Select the primary partition of the system.
3. Expand **Configuration and Service** and select **Logical Partitions**.
4. Right-click the **Logical Partition** and select **Configure Partitions**. You are now working in the Configure Logical Partitions window.
5. Select the partition from which you would like to move shared processing power.
6. Right-click **Shared pool processors** and select **Move**.

7. Select the units with which you want to work in **Display units in -- Processor pool** . If you need more information on this field, click **Help**.
8. Specify the amount of shared processing power to move in **Amount to move**. This value must be less than the current amount of shared processing power available to the logical partition. The **Amount after move** values for the source must fall within the minimum/maximum ranges specified for shared processing power for both partitions.
9. Select the partition to receive the dedicated processors in **Move to -- Logical partition**.
10. Click **OK** to move the shared processing power you specified.

To move shared processing power from one logical partition to another using the service tools window, follow these steps:

1. In iSeries Navigator, select **My Connections** or your active environment.
2. Select **Open iSeries Navigator service tools window** in the Taskpad window. If the Taskpad window is not displayed, select **View** and select **Taskpad**.
3. Enter the **IP address** of the service tool network interface to which you want to connect. Click **OK**.
4. You will be prompted for your **Service Tools User ID and password**.
5. Expand the system name select **Logical Partitions**.
6. Right-click the logical partition and select **Configure Partitions**. You are now working in the Configure Logical Partitions window.
7. Select the partition from which you would like to move shared processing power.
8. Right-click **Shared pool processors** and select **Move**.
9. Select the units with which you want to work in **Display units in -- Processor pool** . If you need more information on this field, click **Help**.
10. Specify the amount of shared processing power to move in **Amount to move**. This value must be less than the current amount of shared processing power available to the logical partition. The **Amount after move** values for the source must fall within the minimum/maximum ranges specified for shared processing power for both partitions.
11. Select the partition to receive the dedicated processors in **Move to -- Logical partition**.
12. Click **OK** to move the shared processing power you specified.

To move shared processing power from one logical partition to another using Management Central, follow these steps:

1. In iSeries Navigator, expand **Management Central**.
2. Expand **Systems with Partitions**.
3. Select the physical system that has the logical partition with which you want to work.
4. Right-click the logical partition and select **Configure Partitions**. You are now working in the Configure Logical Partitions window.
5. Select the partition from which you would like to move shared processing power.
6. Right-click **Shared pool processors** and select **Move**.
7. Select the units with which you want to work in **Display units in -- Processor pool**. If you need more information on this field, click **Help**.
8. Specify the amount of shared processing power to move in **Amount to move**. This value must be less than the current amount of shared processing power available to the logical partition. The **Amount after move** values for the source must fall within the minimum/maximum ranges specified for shared processing power for both partitions.
9. Select the partition to receive the dedicated processors in **Move to -- Logical partition**.
10. Click **OK** to move the shared processing power you specified.

Schedule moving logical partition resources

Understand how to schedule moves of memory, processors, interactive performance, and I/O processors.

You can schedule the movement of memory, processors, interactive performance, and I/O processors. You have the option of choosing to perform a task immediately or choosing a later time. Using the logical partition scheduling functions, gives you the flexibility to accommodate changing workloads and demands on resources.

You need to meet Dedicated Service Tools (DST) and i5/OS security requirements before scheduled LPAR moves will work successfully.

The primary partition for the system where the resource move will occur must have the DST password level set to use password support. To change the DST password level, follow these steps:

1. From DST, select option 5 (Work with DST environment).
2. Select option 6 (Service tools security data).
3. Select option 6 (Password level).
4. Press Enter to confirm the password level change.

The DST user ID password must be changed AFTER the DST password level is set to apply the new encryption level to the DST user ID. This ID is the uppercase equivalent of the same user profile. For example, OS/400user/password= 'BOB'/'mypass' needs DST user='BOB'/'MYPASS'. The DST user profile needs the following authority:

1. System Partitions - Operations
or
2. System Partitions - Administration

User profile needs the following special authorities:

1. *ALLOBJ - All object authority
2. *SERVICE - Service

A user profile must exist on the central system and the system where the resource move will occur. By default, Management Central requires the user profile used to sign on to the central system to have the same password on each endpoint system. For more information, see the iSeries Navigator help for the "Require password on endpoint systems" field on the Security tab in Management Central properties.

LPAR resource moves are scheduled and run with the user profile used to access the central system.

The service tools server must be enabled on the target server. To enable the service tools server, follow these steps:

1. From a command line, type ADDSRVTBLE (Add Service Table Entry) and press Enter. The Service Table Entry display appears.
2. Enter the following information:

Note: The following information is case sensitive.

- Service: 'as-sts'
- PORT: 3000
- PROTOCOL: 'tcp'
- TEXT: 'Service Tools Server'
This field is optional, but you are strongly recommended to enter a description of the table entry.
- Press F10 (Additional Parameters).
- ALIAS: 'AS-STS'

The Alias **must** be capitalized because some table searches are case sensitive.

3. Press Enter to add the table entry.
4. Press F3 to Exit the Add Service Table Entry display.

5. Enter ENDTCP (End TCP).
6. Enter STRTCP (Start TCP)
7. Once active, the service tool server starts when TCP/IP starts until the service table entry is removed.

Note: This server was disabled when shipped for security reasons. You should not enable this service on a machine which still has default DST User IDs and passwords (QSECOFR, QSRV, 11111111, or 22222222). These DST profiles are well known and can create a possible security vulnerability since this network service uses DST security for authentication.

Scheduling support uses the QYHCHCOP API.

Schedule moving a dedicated processor:

Dedicated processors are whole processors that are dedicated to a single partition.

The dedicated processor handles the processing for a specific logical partition. To adjust to changing workloads, you can schedule movement of dedicated processors.

To schedule a dedicated processor move using My Connections, follow these steps:

1. In iSeries Navigator, expand **My Connections** or your active environment.
2. Select the primary partition of the system.
3. Expand **Configuration and Service** and select **Logical Partitions**.
4. Right-click the **Logical Partition** and select **Configure Partitions**. You are now working in the Configure Logical Partitions window.
5. Select the partition from which you want to move the dedicated processor.
6. Right-click the dedicated processors you want to move and select **Move**.
7. Specify the dedicated processor to move in **Processors to move**.
8. Click **Schedule** to specify when you want the move to occur.
9. Click **Help** if you need more information about this field.
10. Click **OK**.

To schedule a dedicated processor move using the service tools window, follow these steps:

1. In iSeries Navigator, select **My Connections** or your active environment.
2. Select **Open iSeries Navigator service tools window** in the Taskpad window. If the Taskpad window is not displayed, select **View** and select **Taskpad**.
3. Enter the **IP address** of the service tool network interface to which you want to connect. Click **OK**.
4. You will be prompted for your **Service Tools User ID and password**.
5. Expand the system name select **Logical Partitions**.
6. Right-click the logical partition and select **Configure Partitions**. You are now working in the Configure Logical Partitions window.
7. Select the partition from which you want to move the dedicated processor.
8. Right-click the dedicated processors you want to move and select **Move**.
9. Specify the dedicated processor to move in **Processors to move**.
10. Click **Schedule** to specify when you want the move to occur.
11. Click **Help** if you need more information about this field.
12. Click **OK**.

To schedule a dedicated processor move using Management Central, follow these steps:

1. In iSeries Navigator, expand **Management Central**.
2. Expand **Systems with Partitions**.

3. Select the physical system that has the logical partition with which you want to work.
4. Right-click the logical partition and select **Configure Partitions**. You are now working in the Configure Logical Partitions window.
5. Select the partition from which you want to move the dedicated processor.
6. Right-click the dedicated processors you want to move and select **Move**.
7. Specify the number of dedicated processors to move in **Processors to move**.
8. Click **Schedule** to specify when you want the move to occur.
9. Click **Help** if you need more information about this field.
10. Click **OK**.

Schedule moving interactive performance:

You can specify an interactive performance minimum value equal to the minimum amount of interactive performance needed to support the logical partition.

The maximum value must be less than the amount of interactive performance available on the system. You can use the schedule interactive performance move function to adjust the interactive requirements for partitions.

To schedule an interactive performance move using My Connections, follow these steps:

1. In iSeries Navigator, expand **My Connections** or your active environment.
2. Select the primary partition of the system.
3. Expand **Configuration and Service** and select **Logical Partitions**.
4. Right-click the **Logical Partition** and select **Configure Partitions**. You are now working in the Configure Logical Partitions window.
5. Select the partition from which you want to move interactive performance.
6. Right-click the interactive performance you want to move and select **Move**.
7. Click **Schedule** to specify when you want the move to occur.
8. Click **Help** if you need more information about this field.
9. Click **OK**.

To schedule an interactive performance move using the service tools window, follow these steps:

1. In iSeries Navigator, select **My Connections** or your active environment.
2. Select **Open iSeries Navigator service tools window** in the Taskpad window. If the Taskpad window is not displayed, select **View** and select **Taskpad**.
3. Enter the **IP address** of the service tool network interface to which you want to connect. Click **OK**.
4. You will be prompted for your **Service Tools User ID and password**.
5. Expand the system name select **Logical Partitions**.
6. Right-click the logical partition and select **Configure Partitions**. You are now working in the Configure Logical Partitions window.
7. Select the partition from which you want to move interactive performance.
8. Right-click the interactive performance you want to move and select **Move**.
9. Click **Schedule** to specify when you want the move to occur.
10. Click **Help** if you need more information about this field.
11. Click **OK**.

To schedule an interactive performance move using Management Central, follow these steps:

1. In iSeries Navigator, expand **Management Central**.
2. Expand **Systems with Partitions**.

3. Select the physical system that has the logical partition with which you want to work.
4. Right-click the logical partition and select **Configure Partitions**. You are now working in the Configure Logical Partitions window.
5. Select the partition from which you want to move interactive performance.
6. Right-click the interactive performance you want to move and select **Move**.
7. Click **Schedule** to specify when you want the move to occur.
8. Click **Help** if you need more information about this field.
9. Click **OK**.

Schedule moving an I/O processor:

Scheduled I/O processor moves are successful only if the LPAR configuration does not create any "In Use" or "Unknown State" warnings for the I/O processor.

You must make sure that all I/O adapters under this I/O processor are varied off before the scheduled task runs. You can also schedule the vary off of the I/O adapters by creating and scheduling a Command Definition in the Management Central folder.

All scheduled IOP moves might not be valid when the primary partition has been restarted. Each IOP move uses an LPAR System Resource ID to identify which IOP you want to move. The LPAR Resource ID is valid as long as the primary partition has not been restarted. This implementation only applies to the IOP scheduling function and does not apply to the scheduling of interactive performance, memory, or processing power.

Attention: Use caution when selecting "Remove hardware resource information from source partition" for a scheduled I/O processor move because this removes hardware resource information from the partition that owns the I/O processor when the move runs.

To schedule an I/O processor move using My Connections, follow these steps:

1. Ensure that any devices attached to the I/O processor you want to move are not busy. The devices should be varied off and listed as unavailable hardware.
2. In iSeries Navigator, expand **My Connections** or your active environment.
3. Select the primary partition of the system.
4. Expand **Configuration and Service** and select **Logical Partitions**.
5. Right-click the **Logical Partition** and select **Configure Partitions**. You are now working in the Configure Logical Partitions window.
6. Select the partition from which you want to move I/O processors.
7. Right-click the I/O processor you want to move and select **Move**.
8. Click **Schedule** to specify when you want the move to occur.
9. Click **Help** if you need more information about this field.
10. Click **OK**.

To schedule an I/O processor move using the service tools window, follow these steps:

1. Ensure that any devices attached to the I/O processor you want to move are not busy. The devices should be varied off and listed as unavailable hardware.
2. In iSeries Navigator, select **My Connections** or your active environment.
3. Select **Open iSeries Navigator service tools window** in the Taskpad window. If the Taskpad window is not displayed, select **View** and select **Taskpad**.
4. Enter the **IP address** of the service tool network interface to which you want to connect. Click **OK**.
5. You will be prompted for your **Service Tools User ID and password**.
6. Expand the system name select **Logical Partitions**.

7. Right-click the logical partition and select **Configure Partitions**. You are now working in the Configure Logical Partitions window.
8. Select the partition from which you want to move I/O processors.
9. Right-click the I/O processor you want to move and select **Move**.
10. Click **Schedule** to specify when you want the move to occur.
11. Click **Help** if you need more information about this field.
12. Click **OK**.

To schedule an I/O processor move using Management Central, follow these steps:

1. Ensure that any devices attached to the I/O processor you want to move are not busy. The devices should be varied off and listed as unavailable hardware.
2. In iSeries Navigator, expand **Management Central**.
3. Expand **Systems with Partitions**.
4. Select the physical system that has the logical partition with which you want to work.
5. Right-click the logical partition and select **Configure Partitions**. You are now working in the Configure Logical Partitions window.
6. Select the partition from which you want to move I/O processors.
7. Right-click the I/O processor you want to move and select **Move**.
8. Click **Schedule** to specify when you want the move to occur.
9. Click **Help** if you need more information about this field.
10. Click **OK**.

Schedule moving memory:

When you create a partition, you must add a whole number of megabytes of memory to the partition.

The primary partition needs a minimum of 256 MB of memory while secondary partitions need a minimum of 128 MB. Workload demands might require you to add more MBs to a partition at certain times. You can use the schedule memory move function to adjust memory requirements for partitions.

To schedule a memory move using My Connections, follow these steps:

1. In iSeries Navigator, expand **My Connections** or your active environment.
2. Select the primary partition of the system.
3. Expand **Configuration and Service** and select **Logical Partitions**.
4. Right-click the **Logical Partition** and select **Configure Partitions**. You are now working in the Configure Logical Partitions window.
5. Select the partition from which you are moving the memory.
6. Right-click **Memory** and select **Move**.
7. Specify the amount of memory you want to move in **Memory to move**.
8. Click **Schedule** to specify when you want the move to occur.
9. Click **Help** if you need more information about this field.
10. Click **OK**.

To schedule a memory move using the service tools window, follow these steps:

1. In iSeries Navigator, select **My Connections** or your active environment.
2. Select **Open iSeries Navigator service tools window** in the Taskpad window. If the Taskpad window is not displayed, select **View** and select **Taskpad**.
3. Enter the **IP address** of the service tool network interface to which you want to connect. Click **OK**.
4. You will be prompted for your **Service Tools User ID and password**.

5. Expand the system name select **Logical Partitions**.
6. Right-click the logical partition and select **Configure Partitions**. You are now working in the Configure Logical Partitions window.
7. Select the partition from which you are moving the memory.
8. Right-click **Memory** and select **Move**.
9. Specify the amount of memory you want to move in **Memory to move**.
10. Click **Schedule** to specify when you want the move to occur.
11. Click **Help** if you need more information about this field.
12. Click **OK**.

To schedule a memory move using Management Central, follow these steps:

1. In iSeries Navigator, expand **Management Central**.
2. Expand **Systems with Partitions**.
3. Select the physical system that has the logical partition with which you want to work.
4. Right-click the logical partition and select **Configure Partitions**. You are now working in the Configure Logical Partitions window.
5. Select the partition from which you are moving the memory.
6. Right-click **Memory** and select **Move**.
7. Specify the amount of memory you want to move in **Memory to move**.
8. Click **Schedule** to specify when you want the move to occur.
9. Click **Help** if you need more information about this field.
10. Click **OK**.

Schedule moving a shared processor:

The shared processing pool allows you to assign partial processors to a logical partition.

The physical processors are held in the shared processing pool and are shared among the logical partitions. To accommodate changing workloads, you can schedule the movement shared processing units.

To schedule a shared processor move using My Connections, follow these steps:

1. In iSeries Navigator, expand **My Connections** or your active environment.
2. Select the primary partition of the system.
3. Expand **Configuration and Service** and select **Logical Partitions**.
4. Right-click the **Logical Partition** and select **Configure Partitions**. You are now working in the Configure Logical Partitions window.
5. Select the partition from which you are moving the shared processor.
6. Right-click the shared pool processors you want to move and select **Move**.
7. Specify the number of units in the shared processor pool to move in **Amount to move**.
8. Click **Schedule** to specify when you want the move to occur.
9. Click **Help** if you need more information about this field.
10. Click **OK**.

To schedule a shared processor move using the service tools window, follow these steps:

1. In iSeries Navigator, select **My Connections** or your active environment.
2. Select **Open iSeries Navigator service tools window** in the Taskpad window. If the Taskpad window is not displayed, select **View** and select **Taskpad**.
3. Enter the **IP address** of the service tool network interface to which you want to connect. Click **OK**.

4. You will be prompted for your **Service Tools User ID and password**.
5. Expand the system name select **Logical Partitions**.
6. Right-click the logical partition and select **Configure Partitions**. You are now working in the Configure Logical Partitions window.
7. Select the partition from which you are moving the shared processor.
8. Right-click the shared pool processors you want to move and select **Move**.
9. Specify the number of units in the shared processor pool to move in **Amount to move**.
10. Click **Schedule** to specify when you want the move to occur.
11. Click **Help** if you need more information about this field.
12. Click **OK**.

To schedule a shared processor move using Management Central, follow these steps:

1. In iSeries Navigator, expand **Management Central**.
2. Expand **Systems with Partitions**.
3. Select the physical system that has the logical partition with which you want to work.
4. Right-click the logical partition and select **Configure Partitions**. You are now working in the Configure Logical Partitions window.
5. Select the partition from which you are moving the shared processor.
6. Right-click the shared pool processors you want to move and select **Move**.
7. Specify the number of units in the shared processor pool to move in **Amount to move**.
8. Click **Schedule** to specify when you want the move to occur.
9. Click **Help** if you need more information about this field.
10. Click **OK**.

Install new hardware for logical partitions

Understand the rules on installing hardware to a system with logical partitions.

When you install new hardware in a partitioned environment, you should be aware of the following things:

- Verify that your logical partition configuration is current. You might need to clear nonreporting resources from your LPAR configuration.
- Empty positions on a shared bus might not be owned by a partition. They should be assigned to the partition you want before installing new adapters in them.
- A new device is owned by the logical partition which owns the I/O processor (IOP) to which the device is attached.
- A new IOP or IOA is owned by the partition which owns the dedicated bus.
- A new IOP or IOA is owned by the partition which owns the empty position on a shared bus.
- The primary partition owns a new system bus.
- New processors and memory are available (unassigned) to be assigned to any partition.
- When adding or removing new disk units to your system you might need to clear partition configuration data on the device.
- New 5250 interactive CPW is assigned across partitions by the percentage specified in the create wizard. After an upgrade, ensure partitions are not assigned more 5250 interactive CPW than they can use.

The IBM recommended approach to installing an IOP or IOA is to perform the following steps:

1. Use the clear non-reporting logical partition resources option to remove resources that are no longer available, that are listed twice, or that are no longer on the server.
2. Assign empty positions to the partition you want.

3. Install the new hardware using the Customer Installable Features information.

Related tasks

“Clear nonreporting resources on logical partitions” on page 132

“Clear partition configuration data from nonconfigured disk units” on page 131

When you move disk units among logical partitions or servers, you may need to erase any old configuration data before the server can use the logical partition again.

Install a new software release in the primary partition

Understand the memory requirement for a primary partition.

The minimum memory required by the primary partition may change if you install a new i5/OS software release. A logical partition configuration error may occur if the minimum memory value is insufficient. Use iSeries Navigator to change the minimum and maximum memory value for each partition.

Note - SRC Error B600 5390: When installing a new release to a partition, this error usually indicates that the partition to which you are installing does not have enough minimum memory to restart. To increase the minimum memory for the partition, you must reconfigure the partition’s memory using iSeries Navigator or the character-based interface. When reconfiguring, the system will provide suggested memory minimums.

For more information on installing i5/OS, refer to Install the i5/OS release and related software.

Expansion unit conversions in a partitioned environment

Understand how to converge expansion units on partitioned 8xx or 270 iSeries servers.

Detailed planning is necessary prior to beginning the expansion unit conversion of a partitioned server. It is highly recommended that all of the logical partition configuration actions be performed by an LPAR trained services person.

Refer to Convert expansion units for a partitioned server for detailed instructions on the following feature conversions:

- Feature conversion 5065 to 5074
- Feature conversion 5066 to 5079
- Feature conversion 5075 to 5074

Related tasks

Install a fix

Restart and power down a system with logical partitions

Understand how to safely restart and power down a system with logical partitions.

At times you will need to perform an initial program load (IPL) or power down the entire system or a single partition.

It is important to remember that when you perform an IPL on the primary partition you are also performing an IPL on all the secondary partitions.

If you power down the primary partition, you will also power down any secondary partitions that are running. Unless you power down the secondary partitions before the primary partition, any secondary partitions that are still running may have an abnormal IPL.

Refer to Basic system operations for more information on abnormal IPLs.

Some of the IPL tasks you can perform are as follows:

- Change a logical partition power schedule

- Change the time on a primary partition.
- Power down the system.
- Restart the system.
- Change operating mode for a logical partition.
- Change the IPL source for a logical partition.
- Restart a secondary logical partition during a system restart.
- Prevent a secondary logical partition from restarting during a system restart.

Related concepts

“Change logical partition power schedule”

You can schedule when a secondary partition will power on and power off by changing the IPL Date and Time (QIPLDATTIM) system value. You can change the QIPLDATTIM system value in Management Central in iSeries Navigator.

“Change the time on a primary partition” on page 86

When changing the time on the primary partition, verify that all secondary partitions are powered on. This will ensure that the configuration data for each secondary load source is updated appropriately.

“Power down a system with logical partitions” on page 86

The proper way to power down a secondary partition is by using the i5/OS power down system (PWRDWN SYS) command.

“Change the operating mode for a logical partition” on page 88

The operating mode for logical partitions works just like operating mode on a system without logical partitions.

“Change the IPL source for a logical partition” on page 89

You can choose a separate initial program load (IPL) source (type) for each logical partition.

“Resolve system reference codes for logical partitions” on page 111

Find a list of common system reference codes and a suggested corrective action for logical partitions.

“Logical partition concept: memory” on page 15

Processors use memory to temporarily hold information.

Related tasks

“Dynamically move interactive performance” on page 69

You can set up interactive performance so that you can change the values between logical partitions without needing to restart the entire system.

“Dynamically move memory” on page 72

Memory in each logical partition operates within its assigned minimum and maximum values.

“Restart a secondary logical partition during a system restart” on page 89

“Prevent a secondary logical partition from restarting during a system restart” on page 90

When you select this option the logical partition will not start when you perform a system (primary partition) restart or initial program load (IPL).

“Restart a system with logical partitions” on page 87

To restart the whole system (perform a power down and an initial program load (IPL)) the secondary partitions must power down with the primary partition.

Change logical partition power schedule:

You can schedule when a secondary partition will power on and power off by changing the IPL Date and Time (QIPLDATTIM) system value. You can change the QIPLDATTIM system value in Management Central in iSeries Navigator.

At a command line on a secondary partition workstation, use the GO POWER or CHGPWRSCD command to change a secondary partition power schedule.

When you schedule a secondary partition to power on, ensure that it is only during a time when the primary partition is already on. You have to power on the primary partition before you can power on any secondary partitions.

See Basic system operations for more information about power schedules.

Related concepts

“Restart and power down a system with logical partitions” on page 84

Understand how to safely restart and power down a system with logical partitions.

Change the time on a primary partition:

When changing the time on the primary partition, verify that all secondary partitions are powered on. This will ensure that the configuration data for each secondary load source is updated appropriately.

The following information applies only to **primary partitions**.

If a secondary partition is powered down when the time is changed on the primary partition, a system reference code of A6005090 800140A may occur.

To resolve the error, IPL the server in manual mode to accept the load source data. For more information on accepting the load source data, refer to Accept a disk unit as a load source for logical partitions.

Related concepts

“Restart and power down a system with logical partitions” on page 84

Understand how to safely restart and power down a system with logical partitions.

Power down a system with logical partitions:

The proper way to power down a secondary partition is by using the i5/OS power down system (PWRDWNSYS) command.

Power down a secondary partition

From a command line at a workstation on that secondary partition type PWRDWNSYS OPTION (*CNTRLD) DELAY (600) and press Enter.

If you power down a secondary partition, you will not affect any other logical partitions. This command is the preferred way to power down a secondary partition.

Power down the primary partition

Before you power down the primary partition, use the PWRDWNSYS command to power down each of the secondary partitions. Then, use the PWRDWNSYS command to power down the primary partition.

Beginning in V5R2, you can set up confirmation support on the PWRDWNSYS command. This confirmation display will ask you if you want to power down the primary partition while secondary partitions are active. To change the primary PWRDWNSYS command default from a command line, type ADDENVVAR and press Enter. The environment variable is QIBM_PWRDWNSYS_CONFIRM.

From a command line at a workstation on the primary partition type PWRDWNSYS OPTION (*CNTRLD) DELAY (600) and press Enter.

If you do not power down the secondary partitions before the primary partition, all of the active secondary partitions will power down abnormally.

The partition manager will allow secondary partitions to attempt to write changed data from memory to disk units. However, the operating system may not reach normal job termination. The next IPL for the affected secondary partition will be treated as an abnormal IPL and may take much longer to complete.

Delayed power off

Use delayed power off (the power button on the remote control panel) only when you must power down a logical partition, and the PWRDWNSYS command does not work.

When you use the delayed power off option, the partition waits a predetermined amount of time to power down. This allows the partition time to end jobs and write data to disks. If the partition is unable to shut down within the predetermined amount of time, it will end abnormally and the next restart may take a long time.

Immediate power off

Use immediate power off (function 8 on the remote control panel) only when a logical partition cannot power down using PWRDWNSYS or delayed power off.

When you use the immediate power off option from the remote control panel, the system powers down without any preset delay. This may cause an abnormal IPL of the logical partition and possibly cause loss of data.

To perform a delayed power off or an immediate power off, you should be working with the remote control panel. The **power button** will start a delayed power off and **function 8** will start an immediate power off of a system. You need a Service Tools user ID with operations or administration authority to the System Partitions function in Dedicated Service Tools (DST) to display the remote control panel.

Refer to Control panel functions for information on how to use the remote control panel and Restart the system (IPL) for instructions on how to restart your server.

Related concepts

“Restart and power down a system with logical partitions” on page 84
Understand how to safely restart and power down a system with logical partitions.

Related tasks

“Restart a system with logical partitions”
To restart the whole system (perform a power down and an initial program load (IPL)) the secondary partitions must power down with the primary partition.

Restart a system with logical partitions:

To restart the whole system (perform a power down and an initial program load (IPL)) the secondary partitions must power down with the primary partition.

If you are going to restart the primary partition, first power down all of the secondary partitions.

You can restart a secondary partition without affecting the other secondary partitions. If the secondary partition is powered on, you can restart it using PWRDWNSYS OPTION *CNTRLD DELAY (600) RESTART (*YES). You can use this command from a command line at one of its workstations or use the Run Command in iSeries Navigator.

Secondary Partition State	Unattended IPL	Attended IPL
Running with i5/OS active	<ol style="list-style-type: none"> 1. Use the remote control panel for the logical partition to select normal mode and to set the appropriate source (type). 2. Right-click the logical partition with which you want to work and select Run Command. 3. Type PWRDWNSYS OPTION (*CNTRLD) DELAY (600) RESTART (*YES) and Click OK. 	<ol style="list-style-type: none"> 1. Use the remote control panel for the logical partition to select manual mode and to set the appropriate source (type) . 2. Right-click the logical partition with which you want to work and select Run Command. 3. Type PWRDWNSYS OPTION (*CNTRLD) DELAY (600) RESTART (*YES) and Click OK.
Running with i5/OS not active	<ol style="list-style-type: none"> 1. Use the remote control panel for the logical partition to select normal mode and to set the appropriate source (type). 2. Use the remote control panel and click the power button. (Delayed power off). 3. Wait for the partition to power off. 4. Use the remote control panel and click the power button again. 	<ol style="list-style-type: none"> 1. Use the remote control panel for the logical partition to select manual mode and to set the appropriate source (type). 2. Use the remote control panel and click the power button. (Delayed power off). 3. Wait for the partition to power off. 4. Use the remote control panel and click the power button again.
Not running	<ol style="list-style-type: none"> 1. Use the remote control panel for the logical partition to select normal mode and to set the appropriate source (type). 2. Use the remote control panel and click the power on button. 	<ol style="list-style-type: none"> 1. Use the remote control panel for the logical partition to select manual mode and to set the appropriate source (type). 2. Use the remote control panel and click the power on button.

See Basic system operations for more information on performing attended or unattended IPLs. Operations Console provides additional information on the remote control panel.

Related concepts

“Restart and power down a system with logical partitions” on page 84

Understand how to safely restart and power down a system with logical partitions.

“Power down a system with logical partitions” on page 86

The proper way to power down a secondary partition is by using the i5/OS power down system (PWRDWNSYS) command.

“Change the IPL source for a logical partition” on page 89

You can choose a separate initial program load (IPL) source (type) for each logical partition.

Related tasks

“Restart a secondary logical partition during a system restart” on page 89

“Start SST and DST for logical partitions” on page 62

Look here for information about starting SST and DST on primary and secondary partitions.

Change the operating mode for a logical partition:

The operating mode for logical partitions works just like operating mode on a system without logical partitions.

For more information on how operating mode works and why you may need to change it, refer to Operating Mode of an IPL.

To change the operating mode for a partition, you should be working with the remote control panel. You need a Service Tools user ID with operations or administration authority to the System Partitions function in Dedicated Service Tools (DST).

Refer to Change operating modes and IPL types for instructions on how to change the operating mode for a partition.

Related concepts

“Restart and power down a system with logical partitions” on page 84
Understand how to safely restart and power down a system with logical partitions.

Related tasks

“Start SST and DST for logical partitions” on page 62
Look here for information about starting SST and DST on primary and secondary partitions.

Change the IPL source for a logical partition:

You can choose a separate initial program load (IPL) source (type) for each logical partition.

Each IPL source (A, B, C, or D) on a system with logical partitions works just like it would on a system without logical partitions.

For information on how each IPL source works and why you may need to change it, refer to IPL Type for more information.

Attention: Only a hardware service representative should use IPL source C. Only use IPL source C under the direction of your service representative. Severe data loss can occur with improper use of this function.

To change the IPL source for a partition, you should be working with the remote control panel. You need a Service Tools user ID with operations or administration authority to the System Partitions function in Dedicated Service Tools (DST) to work with the remote control panel.

Refer to Control panel functions for information on how to use the remote control panel and Change operating modes and IPL types for instructions on how to change the IPL source for a partition.

Related concepts

“Restart and power down a system with logical partitions” on page 84
Understand how to safely restart and power down a system with logical partitions.

Related tasks

“Restart a system with logical partitions” on page 87
To restart the whole system (perform a power down and an initial program load (IPL)) the secondary partitions must power down with the primary partition.

Restart a secondary logical partition during a system restart:

When you select this option, you can set a secondary logical partition to start automatically when you perform a system (primary partition) restart or initial program load (IPL).

You can perform this procedure from iSeries Navigator. You need a Service Tools user ID with administration authority to the System Partitions function in Dedicated Service Tools (DST).

To restart a secondary logical partition during a system restart using My Connections, follow these steps:

1. In iSeries Navigator, expand **My Connections** or your active environment.
2. Select the primary partition of the system.
3. Expand **Configuration and Service** and select **Logical Partitions**.

4. Right-click the logical partition and select **Properties**.
5. Select the **Options** page.
6. Select the **Automatically restart when primary partition is restarted** box to automatically restart the secondary partition during a system restart. Click **Help** if you need more information on this field.
7. Click **OK**.

To restart a secondary logical partition during a system restart using the service tools window, follow these steps:

1. In iSeries Navigator, select **My Connections** or your active environment.
2. Select **Open iSeries Navigator service tools window** in the Taskpad window. If the Taskpad window is not displayed, select **View** and select **Taskpad**.
3. Enter the **IP address** of the service tool network interface to which you want to connect. Click **OK**.
4. You will be prompted for your **Service Tools User ID and password**.
5. Expand the system name select **Logical Partitions**.
6. Right-click the logical partition and select **Properties**.
7. Select the **Options** page.
8. Select the **Automatically restart when primary partition is restarted** box to automatically restart the secondary partition during a system restart. Click **Help** if you need more information on this field.
9. Click **OK**.

To restart a secondary logical partition during a system restart using Management Central, follow these steps:

1. In iSeries Navigator, expand **Management Central**.
2. Expand **Systems with Partitions**.
3. Select the physical system that has the logical partition with which you want to work.
4. Right-click the logical partition and select **Properties**.
5. Select the **Options** page.
6. Select the **Automatically restart when primary partition is restarted** box to automatically restart the secondary partition during a system restart. Click **Help** if you need more information on this field.
7. Click **OK**.

Related concepts

“Restart and power down a system with logical partitions” on page 84
Understand how to safely restart and power down a system with logical partitions.

Related tasks

“Restart a system with logical partitions” on page 87
To restart the whole system (perform a power down and an initial program load (IPL)) the secondary partitions must power down with the primary partition.

Prevent a secondary logical partition from restarting during a system restart:

When you select this option the logical partition will not start when you perform a system (primary partition) restart or initial program load (IPL).

You can perform this procedure from iSeries Navigator. You need a Service Tools user profile with administration authority to the System Partitions function in Dedicated Service Tools (DST). To prevent a secondary logical partition from restarting during a system restart, follow these steps:

To prevent a secondary logical partition from restarting during a system restart using My Connections, follow these steps:

1. In iSeries Navigator, expand **My Connections** or your active environment.

2. Select the primary partition of the system.
3. Expand **Configuration and Service** and select **Logical Partitions**.
4. Right-click the logical partition and select **Properties**.
5. Select the **Options** page.
6. Deselect the **Automatically restart when primary partition is restarted** box to hold the logical partition from restarting during the system restart. Click **Help** if you need more information on this field.
7. Click **OK**.

To prevent a secondary logical partition from restarting during a system restart using the service tools window, follow these steps:

1. In iSeries Navigator, select **My Connections** or your active environment.
2. Select **Open iSeries Navigator service tools window** in the Taskpad window. If the Taskpad window is not displayed, select **View** and select **Taskpad**.
3. Enter the **IP address** of the service tool network interface to which you want to connect. Click **OK**.
4. You will be prompted for your **Service Tools User ID and password**.
5. Expand the system name select **Logical Partitions**.
6. Right-click the logical partition and select **Properties**.
7. Select the **Options** page.
8. Deselect the **Automatically restart when primary partition is restarted** box to hold the logical partition from restarting during the system restart. Click **Help** if you need more information on this field.
9. Click **OK**.

To prevent a secondary logical partition from restarting during a system restart using Management Central, follow these steps:

1. In iSeries Navigator, expand **Management Central**.
2. Expand **Systems with Partitions**.
3. Select the physical system that has the logical partition with which you want to work.
4. Right-click the logical partition and select **Properties**.
5. Select the **Options** page.
6. Deselect the **Automatically restart when primary partition is restarted** box to hold the logical partition from restarting during the system restart. Click **Help** if you need more information on this field.
7. Click **OK**.

Related concepts

“Restart and power down a system with logical partitions” on page 84
Understand how to safely restart and power down a system with logical partitions.

Troubleshoot logical partitions

Resolve logical partition errors efficiently using the troubleshooting advisor. You can also determine whether the server having problems has logical partitions so that you can more quickly find a solution.

If you have problems with a partitioned system, determine if the problem is specific to logical partitions or a general system problem. If your problem is specific to logical partitions, use this section along with the SRC finder to understand system reference codes (SRCs) and recovery action needed to resolve the error. However, specific recovery actions and tasks might require the assistance of the Technical Support Center.

Related concepts

Related reference

Linux in a guest partition

System reference codes (SRCs) for logical partitions

Find a list that contains the common SRCs that the PAL can report.

The following table contains the common SRCs that the PAL can report. Suggested corrective actions follow each SRC. If an SRC is not listed, it might not be related to logical partitions.

Note: In the following table, the xx numbers in the SRC codes equal the partition ID.

Table 11. Common SRCs that the PAL can report

SRC	Information
1 B2xx 1230	<p>Cause: The secondary partition could not perform the IPL. The IPL is ended. An example of what causes this SRC to appear is not assigning the correct amount of processors or memory to a secondary partition.</p> <p>Recovery: From the Work With System Partitions display, correct the configuration problem based on the reason code, then try the secondary partition's IPL again. If it continues to fail, contact your service provider.</p> <p>Problem analysis procedure: Identify the reason code from word 3 of the SRC. Possible reason code values are the following:</p> <ul style="list-style-type: none"> • 000000A2: Insufficient amount of interactive performance • 000000A3: Insufficient number of processors • 000000A4: Insufficient main storage size <p>For any other reason code, contact your service provider.</p>
B2xx 1250	<p>Cause: The primary partition's IPL mode does not allow the secondary partition to IPL the given mode. The IPL is ended. An example of what causes this SRC to appear is the primary partition is in C-mode IPL and the secondary partition is B-mode IPL. When the primary partition is in a D-mode IPL, the secondary partitions are not allowed to IPL at all.</p> <p>Recovery: Go to the Work With System Partitions display and assign the secondary partitions the same IPL mode as the primary partition. Then, try the secondary partition IPL again. If the problem continues to fail, contact your service provider.</p> <p>Problem analysis procedure: Collect the detailed hexadecimal data from the product activity log (PAL) entry for this problem.</p>

Table 11. Common SRCs that the PAL can report (continued)

SRC	Information
B2xx 1260	<p>Cause: The Timed Power On (TPO) setting was reached for a secondary partition, but the keylock was not set to Automatic or Normal. The IPL will end.</p> <p>Recovery: Go to the Work With System Partitions display and change the keylock from its current setting of Manual-Secure to Normal- Automatic. Then, try the secondary partition IPL again. If the problem continues to fail, contact your service provider.</p> <p>Problem analysis procedure: Collect the detailed hexadecimal data from the product activity log (PAL) entry for this problem.</p>
B2xx 1310	<p>Cause: No alternate (D-mode) IPL device IOP selected. The IPL will attempt to continue, but there might not be enough information to find the correct D-mode load source.</p> <p>Recovery: Go to the Work With System Partitions display and configure an alternate IPL IOP for the secondary partition. Then, try the secondary partition IPL again. If it continues to fail, contact your service provider.</p> <p>Problem analysis procedure: Collect the detailed hexadecimal data from the product activity log (PAL) for this problem for your service provider.</p>
B2xx 1320	<p>Cause: No default load source IOP selected for an A-mode or a B-mode IPL. The IPL will attempt to continue, but there might not be enough information to find the correct load source.</p> <p>Recovery: Go to the Work With System Partitions display and configure a load source IOP for the secondary partition. Then, try the secondary partition IPL again. If it continues to fail, contact your service provider.</p> <p>Problem analysis procedure: Collect the detailed hexadecimal data from the product activity log (PAL) for this problem for your service provider.</p>
B2xx 3110	<p>Cause: All load source candidates have been scanned for valid secondary partition code. However, in all cases, errors were encountered that prevented each from being used as a load source candidate for the IPL. The IPL is ended.</p> <p>Recovery: Address each problem found, and then try the secondary partition's IPL again. If it continues to fail, contact your service provider.</p> <p>Problem analysis procedure: Scan the secondary partition's SRC history list for prior B2ppxxxx failure SRCs (where pp is the partition ID) to pinpoint the source of the problem.</p>

Table 11. Common SRCs that the PAL can report (continued)

SRC	Information
B2xx 3123	<p>Cause: The IOA slot does not belong to the IOP. A check is made to the specific IOP to ensure an IOA slot has been assigned to it. This SRC indicates that no IOA slot has been assigned to an IOP, and hence all unit addresses under this slot will not be attempted. The IPL will attempt to continue by skipping to the next slot address.</p> <p>Recovery: This SRC probably indicates a LPAR configuration error. Use the Work with Partitions display to check your partition configuration to ensure that all the slots are allocated to the partition correctly.</p> <p>Problem analysis procedure: Use the product activity log (PAL) to find SRCs that pertain to the device address referenced in words 13-16 of the SRC. Correct any problems found, and then retry the secondary IPL.</p>
B2xx 3125	<p>Cause: Memory allocation for early IPL objects failed. The primary is low on memory. The IPL sequence will be retried to the same device.</p> <p>Recovery: If the primary partition does not have enough main storage, remove some main storage from one or more secondary partitions, then add it to the primary partition. If the primary partition does have enough main storage, try the IPL again. If it continues to fail, contact your service provider.</p> <p>Problem analysis procedure: Ensure that the primary partition has an adequate amount of main storage available to perform the IPL of the secondary partition.</p>
B2xx 3130	<p>Cause: No bus object was found for the specified bus number. The IPL will attempt to continue, but all subsequent load source devices at this bus address will be skipped.</p> <p>Recovery: If word 3 is zero, then is SRC is informational and can be ignored. A nonzero bus number has no associated bus object. Contact your service provider to resolve the issue.</p> <p>Problem analysis procedure: The value for word 3 is as follows:</p> <ul style="list-style-type: none"> • Word 3: Bus address information <p>This value can help you to identify the hardware that caused the error.</p>

Table 11. Common SRCs that the PAL can report (continued)

SRC	Information
B2xx 3135	<p>Cause: The Transport Manager bus object type is neither SPD nor PCI. The only known bus types are RIO, SAN, and Virtual and none of these support the IPL mode as an LPAR load source. The entire bus will be skipped. The IPL will attempt to continue.</p> <p>Recovery: Contact your service provider to resolve the issue.</p> <p>Problem analysis procedure: The value for word 3 is as follows:</p> <ul style="list-style-type: none"> • Word 3: Bus address information <p>This value can help you to identify the hardware that caused the error.</p>
B2xx 3200	<p>Cause: The command (Initiate Self Load) sent to the IOP telling it to locate the selected load source device and load or reset itself has failed. The IPL will attempt to continue, and depending on the type of failure, the load source device can be retried or skipped.</p> <p>Recovery: Look for SRCs in the PAL relating to the device location specified in words 3-6. Follow the recovery actions for problems found. Then, try the secondary partition IPL again. If it continues to fail, contact your service provider.</p> <p>Problem analysis procedure: The values for words 3-6 are as follows:</p> <ul style="list-style-type: none"> • Word 3: Bus address information • Word 4: Board address information • Word 5: Card address information • Word 6: Unit address information <p>These values can help you to identify the hardware that caused the error.</p>
B2xx 4310	<p>Cause: The load source device hardware drive has no HRI object. The IPL will attempt to try the entire IPL sequence from the specified load source again.</p> <p>Recovery: If your IPL failed due to this SRC, capture a primary partition MSD and contact your service provider.</p> <p>Problem analysis procedure: The value for word 3 is as follows:</p> <ul style="list-style-type: none"> • Word 3: Bus address information • Word 4: Board address information • Word 5: Card address information • Word 6: Unit address information <p>This value can help you to identify the hardware that caused the error.</p>

Table 11. Common SRCs that the PAL can report (continued)

SRC	Information
B2xx 4312	<p>Cause: A mismatch has occurred between the expected load source candidate device's logical device location and the enlisted load source candidate device. The IPL will attempt to try the entire IPL sequence from the specified load source again.</p> <p>Recovery: If your IPL failed due to this SRC, capture a primary partition MSD and contact your service provider.</p> <p>Problem analysis procedure: The value for word 3 is as follows:</p> <ul style="list-style-type: none"> • Word 3: Bus address information • Word 4: Board address information • Word 5: Card address information • Word 6: Unit address information <p>This value can help you to identify the hardware that caused the error.</p>
B2xx 4315	<p>Cause: A failure occurred when attempting to allocate storage in the primary partition.</p> <p>Recovery: If the primary partition does not have enough main storage, remove some main storage from one or more secondary partitions, then add it to the primary partition.</p> <p>Problem analysis procedure: Ensure the primary partition has an adequate amount of memory. Try the secondary partition IPL again.</p>
B2xx 4320	<p>Cause: The wrong kind of primary load source reported. The IPL will attempt to proceed by skipping all subsequent attempts to this device.</p> <p>Recovery: Verify your hardware configuration for the secondary partition.</p> <p>Problem analysis procedure: Ensure that the devices are located in the correct location.</p>
B2xx 4321	<p>Cause: The wrong kind of alternate load source reported. The IPL will attempt to continue by skipping all subsequent attempts to this device.</p> <p>Recovery: Verify your hardware configuration for the secondary partition.</p> <p>Problem analysis procedure: Ensure that the devices are located in the correct slot.</p>

Table 11. Common SRCs that the PAL can report (continued)

SRC	Information
B2xx 5106	<p>Cause: Creation of main storage dump-temporary segment has failed. An example of what causes this failure is running out of memory in the primary partition. The IPL will be retried to the same device unit address, under the assumption that this is a temporary condition.</p> <p>Recovery: If the primary partition does not have enough main storage, remove some main storage from one or more secondary partitions, then add it to the primary partition. If the primary partition does have enough main storage, try the IPL again. If it continues to fail, contact your service provider.</p> <p>Problem analysis procedure: Ensure that the primary partition has an adequate amount of main storage available to perform the IPL of the secondary partitions.</p>
B2xx 5114	<p>Cause: The secondary load source has allocated a MSD that is smaller than the minimum dump size. No dump can be captured. The IPL will end.</p> <p>Recovery: Contact your service provider.</p> <p>Problem analysis procedure: Collect the detailed hexadecimal data from the product activity log (PAL) entry for this problem. Contact your service provider.</p>
B2xx 5115	<p>Cause: Loading from the load source has failed. The IPL will attempt to continue by trying the entire IPL sequence to the same load source device again.</p> <p>Recovery: If this SRC is preventing the secondary IPL from continuing, focus on the load source device at the location specified in words 3-6. Try the secondary partition's IPL again, after fixing any problems found.</p> <p>Problem analysis procedure: These values for words 3-6 is as follows:</p> <ul style="list-style-type: none"> • Word 3: Bus information • Word 4: Board information • Word 5: Card information • Word 6: Unit information <p>These values can help you to identify the hardware that caused the error.</p> <p>Collect the detailed hexadecimal data from the product activity log (PAL) for this problem for your service provider.</p>

Table 11. Common SRCs that the PAL can report (continued)

SRC	Information
B2xx 5117	<p>Cause: An MSD or CPM IPL has occurred, but the current information cannot be written to the load source device because a valid dump already exists. The current MSD or CPM information is lost, and the IPL is ended.</p> <p>Recovery: Perform the IPL of the secondary partition past dedicated service tools (DST) to invalidate the old MSD or CPM information on the load source. Then, subsequent MSD or CPM dumps can be saved.</p> <p>Problem analysis procedure: Identify the partition that has the problem through the partition identification number (xx) given in the SRC.</p>
B2xx 5121	<p>Cause: An MSD or CPM IPL has occurred, but the current information cannot be written to the load source device because a valid dump already exists. The current MSD or CPM information is lost, and the IPL is ended.</p> <p>Recovery: Perform the IPL of the secondary partition past dedicated service tools (DST) to invalidate the old MSD or CPM information on the load source. Then, subsequent MSD or CPM dumps can be saved.</p> <p>Problem analysis procedure: Collect the detailed hexadecimal data from the product activity log (PAL) and fix any problems found.</p>
B2xx 5135	<p>Cause: A disk unit write operation has failed during the writing of MSD or CPM mainstore pages. A partial dump of phase II information might be available in the dump and the MSD or CPM IPL will continue.</p> <p>Recovery: Collect the detailed hexadecimal data from the product activity log (PAL) associated with the disk unit at the given location. Fix any potential problems found. This can be a sign of a disk unit, IOP, or Bus problem that needs to be fixed.</p> <p>Problem analysis procedure: Identify the reason code from words 3-9 of the SRC. Possible reason code values are the following:</p> <ul style="list-style-type: none"> • Word 3: bus address information • Word 4: Board address information • Word 5: Card address information • Word 6: Unit address information • Word 7: Number of pages written in the operation • Word 8: Device page position • Word 9: DASD hardware driver return code <p>For any other reason code, contact your service provider.</p>

Table 11. Common SRCs that the PAL can report (continued)

SRC	Information
B2xx 5145	<p>Cause: Storing SID 82 LIDs during Phase II for the MSD or CPM path has failed. Phase II information will most likely not be available in the dump and the MSD or CPM IPL will continue.</p> <p>Recovery: Collect the detailed hexadecimal data from the product activity log (PAL) associated with the disk unit at the given location. Fix any potential problems found. This can be a sign of a disk unit, IOP, or Bus problem that needs to be fixed.</p> <p>Problem analysis procedure: Identify the reason code from words 3-6 of the SRC. Possible reason code values are the following:</p> <ul style="list-style-type: none"> • Word 3: bus address information • Word 4: Board address information • Word 5: Card address information • Word 6: Unit address information <p>For any other reason code, contact your service provider.</p>
B2xx 5148	<p>Cause: A MSD occurred while the system was already performing a MSD or CPM recovery IPL. The first dump has already been copied or cleared. The second dump has been successfully saved into the secondary load source's SID 82, but the secondary partition will not IPL.</p> <p>Recovery: Contact your service provider.</p> <p>Problem analysis procedure: Identify the reason code from words 3-6 of the SRC. Possible reason code values are the following:</p> <ul style="list-style-type: none"> • Word 3: bus address information • Word 4: Board address information • Word 5: Card address information • Word 6: Unit address information <p>For any other reason code, contact your service provider.</p>

Table 11. Common SRCs that the PAL can report (continued)

SRC	Information
B2xx 6012	<p>Cause: A secondary partition LID has been loaded into the partition's main storage successfully. However, it has been determined afterward that the actual LID was not fully contained in the partition's load area, and memory damage or corruption has potentially occurred. The IPL will be terminated.</p> <p>Recovery: Contact your service provider. The secondary partition's load source device is corrupt. A reinstall might be necessary if the load source is DASD.</p> <p>Problem analysis procedure: Identify the reason code from words 3-6 of the SRC. Possible reason code values are the following:</p> <ul style="list-style-type: none"> • Word 3: bus address information • Word 4: Board address information • Word 5: Card address information • Word 6: Unit address information <p>For any other reason code, contact your service provider.</p>
B2xx 6015	<p>Cause: Getting the partition's load data area failed. The IPL will attempt to continue by skipping this device, and trying a subsequent load source candidate device.</p> <p>Recovery: This is likely a problem with the load source media being corrupt or not valid. A re-installation of the Licensed Internal Code of the secondary partition is probably required to recover. If it continues to fail, contact your service provider.</p> <p>Problem analysis procedure: Collect the detailed hexadecimal data from the product activity log (PAL) for this problem for your service provider.</p>
B2xx 6025	<p>Cause: Invalid memory for loading into the load ID. The IPL will attempt to continue by skipping this load source device candidate and trying the next candidate.</p> <p>Recovery: This is likely a problem with the load source media being corrupt or invalid. A re-installation of the Licensed Internal Code of the secondary partition is probably required to recover. If it continues to fail, contact your service provider.</p> <p>Problem analysis procedure: Collect the detailed hexadecimal data from the product activity log (PAL) for this problem for your service provider.</p>

Table 11. Common SRCs that the PAL can report (continued)

SRC	Information
B2xx 6027	<p>Cause: A low memory condition in the primary partition is the most likely cause of this SRC. The entire IPL sequence to the same unit address will be retried.</p> <p>Recovery: If the primary partition does not have enough main storage, remove some main storage from one or more secondary partitions, then add it to the primary partition. If the primary partition does have enough main storage and there are no memory leaks, try the operation again.</p> <p>Problem analysis procedure: Ensure that the partition was allocated enough main storage, verify that no memory leaks are present, and then try the operation again.</p>
B2xx 7111	<p>Cause: The secondary load source does not have an associated IOP hardware driver.</p> <p>Recovery: Capture a primary partition MSD. Contact your service provider to resolve the issue.</p> <p>Problem analysis procedure: Contact your service provider to resolve the issue.</p>
B2xx 7115	<p>Cause: Removing an IOP hardware driver (not the load source for the current IPL) from the primary partition failed. The IPL will continue, but the secondary partition will most likely not be able to establish connections to this IOP.</p> <p>Recovery: You might need to perform another IPL of the secondary partition to recover the specified IOP for use by the secondary partition. If it continues to fail, contact your service provider.</p> <p>Problem analysis procedure: Identify the values for words 3-5 to determine the cause of the error. The values for the words are as follows:</p> <ul style="list-style-type: none"> • Word 3: Bus address information • Word 4: Board address information • Word 5: Card address information

Table 11. Common SRCs that the PAL can report (continued)

SRC	Information
B2xx 7117	<p>Cause: Removing the IOP hardware driver that is associated with the current load source has failed. The IPL will not proceed.</p> <p>Recovery: Collect the detailed hexadecimal data from the product activity log (PAL) related to the specified IOP address. Fix any problems found by following the recovery actions for the PAL SRCs. Try the secondary partition IPL again. An IPL of the primary partition might be required to regain control of the IOP.</p> <p>Problem analysis procedure: Identify the reason code from words 3-6 of the SRC. Possible reason code values are the following:</p> <ul style="list-style-type: none"> • Word 3: bus address information • Word 4: Board address information • Word 5: Card address information • Word 6: IOP return code <p>For any other reason code, contact your service provider.</p>
B2xx 7200	<p>Cause: An error condition was encountered when attempting to send the exit VSP mode command (PCI-only bus command) to the load source IOP.</p> <p>Recovery: Collect the detailed hexadecimal data from the product activity log (PAL) related to the specified IOP address. Fix any problems found by following the recovery actions for the PAL SRCs. Try the secondary partition IPL again. An IPL of the primary partition might be required to regain control of the IOP.</p> <p>Problem analysis procedure: Identify the reason code from words 3-5 of the SRC. Possible reason code values are the following:</p> <ul style="list-style-type: none"> • Word 3: bus address information • Word 4: Board address information • Word 5: Card address information <p>For any other reason code, contact your service provider.</p>
B2xx 8105	<p>Cause: Initialization of secondary partition main storage data structures failed. The IPL is ended.</p> <p>Recovery: This is likely a problem with the load source media being corrupt or invalid. A re-installation of the Licensed Internal Code of the secondary partition is probably required to recover. If it continues to fail, contact your service provider.</p> <p>Problem analysis procedure: Collect the detailed hexadecimal data from the product activity log (PAL) for this problem for your service provider.</p>

Table 11. Common SRCs that the PAL can report (continued)

SRC	Information
B2xx 8107	<p>Cause: Failed to allocate main storage for Licensed Internal Code event messages. This indicates that free main storage is low in the primary partition. The IPL is ended.</p> <p>Recovery: If the primary partition does not have enough main storage, remove some main storage from one or more secondary partitions, then add it to the primary partition.</p> <p>Problem analysis procedure: Ensure the primary partition has an adequate amount of main storage to IPL the secondary partition.</p>
B2xx 8115	<p>Cause: The opening Licensed Internal Code Session Manager connections failed for some or all of the connections. The IPL will continue, but some connections will not be functional.</p> <p>Recovery: You might need to perform another IPL of the secondary partition to recover the Licensed Internal Code Session Manager connections. If it continues to fail, contact your service provider.</p> <p>Problem analysis procedure: Collect the detailed hexadecimal data from the product activity log (PAL) for this problem for your service provider.</p>
1 B600 5310	<p>Cause: Logical partition configuration data has a consistency error. The server cannot find a working copy of the configuration data for the logical partition.</p> <p>Recovery: Contact your service provider. The server will not continue its IPL past dedicated service tools (DST) until the problem is corrected.</p> <p>Problem analysis procedure: Collect the detailed hexadecimal data from the product activity log (PAL) for this problem for your service provider.</p>

Table 11. Common SRCs that the PAL can report (continued)

SRC	Information
1 B600 5311	<p>Cause: Logical partition configuration data does not match the current server configuration. Possible causes include:</p> <ul style="list-style-type: none"> • A nonconfigured disk unit which was previously a load source for a logical partition. • Load source configuration data does not match the logical partition for which it is being used. • Load source configuration data does not match the server serial number for which it is being used. • Load source configuration data is newer than the primary partition configuration data. <p>Recovery: Perform one of the following tasks:</p> <ul style="list-style-type: none"> • If the load source has been replaced inadvertently, return the original and restart the server. • If the load source is for the primary partition, recover the logical partition configuration data. • If the specified load source is for a secondary partition, accept the disk as a load source for that secondary partition. • If the specified disk unit is not configured, clear the nonconfigured load source to use the new disk unit in the server. • If a load source disk unit has been moved from a server that has logical partitions, but the current server should not have logical partitions, clear all partition configuration data. This will delete all secondary partitions. • If the load source came from a partitioned server and was inadvertently used to perform a partition IPL, do not take any action. The initialize disk process during installation clears existing configuration data. <p>The logical partition will not continue its IPL past DST until the problem is corrected with one of the above actions.</p> <p>Problem analysis procedure: Collect the detailed hexadecimal data from the product activity log (PAL) entry for this problem for your service provider.</p>
1 B600 5312	<p>Cause: Informational indication that the server detected and corrected a configuration data inconsistency on a logical partition without any loss of data.</p> <p>Recovery: None.</p> <p>Problem analysis procedure: None unless a significant number of errors occur. Collect the detailed hexadecimal data from the product activity log (PAL) entries for these problems for your service provider.</p>

Table 11. Common SRCs that the PAL can report (continued)

SRC	Information
1 B600 5313	<p>Cause: The server detected a configuration data inconsistency for a logical partition and could not correct it without loss of the last configuration data update.</p> <p>Recovery: Manually validate configuration data and repeat any missing configuration actions.</p> <p>Problem analysis procedure: None unless a significant number of errors occur. Collect the detailed hexadecimal data from the product activity log (PAL) entries for these problems for your service provider.</p>
B600 5320	<p>Cause: An I/O Adapter used by a guest partition is located in a card position on the same Multi-adapter bridge domain as an I/O Processor. Guest partition data might be lost if any of the following occur:</p> <ul style="list-style-type: none"> • A primary partition Type D IPL is performed. • The I/O Adapter is moved to an i5/OS partition. • An error causes the Logical partition (LPAR) configuration data to not be used. <p>Recovery: Use the LPAR Validation Tool (LVT) to create a valid LPAR configuration. For more information about the LPAR Validation Tool, see the following Web site: http://www.ibm.com/eserver/series/lpar</p> <p>Problem analysis procedure: Use the product activity log (PAL) to check the reason code from words 3-9 of the SRC. Use the reason code from words 3-9 to identify the location of the IOP and IOA. Possible reason code values are the following:</p> <ul style="list-style-type: none"> • Word 3: IOP partition ID • Word 4: IOP Frame ID • Word 5: IOP slot • Word 6: IOA partition ID • Word 7: IOA Frame ID • Word 8: IOA slot • Word 9: IOA Type number <p>For any other reason code, contact your service provider</p>
1 B600 5340	<p>Cause: A logical partition is running with less than the requested number of processors.</p> <p>Recovery: Perform recovery for the processor-specific errors that are logged in the primary partition.</p> <p>Problem analysis procedure: Check the product activity log (PAL) in the primary partition for SRCs that indicate hardware errors that should be corrected.</p>

Table 11. Common SRCs that the PAL can report (continued)

SRC	Information
1 B600 5341	<p>Cause: A logical partition is running with less than the requested amount of main storage.</p> <p>Recovery: Perform recovery for the main storage-specific errors that are logged in the primary partition.</p> <p>Problem analysis procedure: Check the product activity log (PAL) in the primary partition for SRCs that indicate hardware errors that should be corrected.</p>
B600 5342	<p>Cause: A logical partition has an insufficient number of processors. The logical partitions processor minimums could not be satisfied.</p> <p>Recovery: All resources have been temporarily assigned to the primary. Perform recovery for the processor specific errors that are logged in the primary partition.</p> <p>Problem analysis procedure: Check the product activity log (PAL) for hardware errors.</p>
B600 5343	<p>Cause: A logical partition has an insufficient amount of memory. The logical partitions memory minimums could not be satisfied.</p> <p>Recovery: All resources have been temporarily assigned to the primary. Perform recovery for the memory specific errors that are logged in the primary partition.</p> <p>Problem analysis procedure: Check the product activity log (PAL) for hardware errors.</p>
B600 5344	<p>Cause: A logical partition has an insufficient amount of interactive performance. The logical partitions interactive performance minimums could not be satisfied.</p> <p>Recovery: All resources have been temporarily assigned to the primary. Perform recovery for the interactive performance specific errors that are logged in the primary partition.</p> <p>Problem analysis procedure: Check the product activity log (PAL) for hardware errors.</p>
1 B600 5350	<p>Cause: A logical partition software version is outside of the supported secondary partition release delta.</p> <p>Recovery: Perform one of the following:</p> <ul style="list-style-type: none"> • Install a supported operating system version in the logical partition that has the problem. • Install an operating system version in the primary partition that supports the version in the offending logical partition. <p>Problem analysis procedure: Display the logical partition release level and check the logical partition release delta.</p>

Table 11. Common SRCs that the PAL can report (continued)

SRC	Information
1 B600 5380	<p>Cause: An unexpected event occurred in the logical partition management code that was recovered.</p> <p>Recovery: Contact your service provider if a significant number of these errors have occurred.</p> <p>Problem analysis procedure: Collect the detailed hexadecimal data from the product activity log (PAL) entry for this problem.</p>
1 B600 5390	<p>Cause: An unexpected event occurred in the logical partition management code which could not be recovered. Further changes to the logical partition configuration might not be possible.</p> <p>Recovery: If this error occurs on an installation or upgrade, the most likely resolution is to increase the minimum memory of the partition to which you are installing or upgrading. If increasing the minimum memory does not resolve the issue, contact your service provider. The server might not IPL past DST until the problem is corrected.</p> <p>Problem analysis procedure: Collect the detailed hexadecimal data from the product activity log (PAL) entry for this problem.</p>

Related concepts

“Manage security for logical partitions” on page 67

Understand who has authority to perform logical partition tasks and how to restrict access to the system.

Troubleshooting and Service

Related tasks

“View the Product Activity Log (PAL) for logical partitions” on page 109

Use Dedicated Service Tools (DST) or System Service Tools (SST) to find system reference codes for logical partitions.

Determine whether the server has logical partitions

Use iSeries Navigator to determine whether the server has been configured to run logical partitions.

All systems ship with a primary partition. You can create logical partitions on systems depending on the hardware and release you are currently running.

To determine if your server has logical partitions in V5R1 or later releases, complete the following steps:

1. Using iSeries Navigator, select **My Connections**.
2. Expand the physical system with which you want to work.
3. Select **Configurations and Service** and select Logical partitions. If the system has logical partitions, it lists all of partitions on the server.

System reference codes (SRCs) for logical partitions

Understand how to determine whether your server has run into any logical partitioning errors.

System reference codes (SRCs) can appear on the control panel, the product activity log (PAL), the Main Storage Dump Manager display, in iSeries Navigator, or on various displays within DST or SST.

SRCs consist of nine "words" that you can view by accessing the control panel function that corresponds to that word. SRCs for secondary partitions are found on the virtual control panel. A word usually consists of 8 hexadecimal characters (0-9 and A-F). The function corresponds to the function on the control panel that would show the specific word of the SRC.

V4R5 and later releases

The iSeries servers have a control panel that can display up to four words at the same time. In addition, the first word of the SRC can be any ASCII character. The other eight words of the SRC still consist of hexadecimal data.

Function 11 still displays the first word of the SRC. However, the first word can contain 8 to 32 characters.

Since you can display up to 4 words of the SRC at a time, the function you use to see the word is different for V4R5 and later releases. Functions 11 through 13 show all nine words of the SRC. Functions 14 through 19 are not available.

In the PAL and other software displays, the SRC appears much like it does for earlier releases. One difference is that the first word will have up to 32 characters of text. Another difference is that the word will be a number from 1 to 9 instead of 11 to 19. This helps to avoid confusing the word number with the function number used to find it.

The SRCs for V4R5 and later releases display as follows:

Function	Word
11	1
	expanded word 1
	expanded word 1
	expanded word 1
12	2
	3
	4
	5
13	6
	7
	8
	9

V4R4

For V4R4 hardware and software, the word number is the same as the function number to which it corresponds. For example, word 11 of the SRC appears in function 11.

In the PAL and other software displays, the SRC appears as nine rows of hexadecimal data. Each row represents a function, and the word number displays in front of the hexadecimal data.

The complete list of words and functions for V4R4 and earlier releases are as follows:

Function	Word
11	11

Function	Word
12	12
12	13
14	14
15	15
16	16
17	17
18	18
19	19

Related concepts

“Resolve system reference codes for logical partitions” on page 111

Find a list of common system reference codes and a suggested corrective action for logical partitions.

Related tasks

“View the Product Activity Log (PAL) for logical partitions”

Use Dedicated Service Tools (DST) or System Service Tools (SST) to find system reference codes for logical partitions.

“Copy partition configuration data between IPL sources” on page 133

Your server may experience a disk read error of logical partition configuration data if you restart from the A or B IPL source, but not both

View the Product Activity Log (PAL) for logical partitions

Use Dedicated Service Tools (DST) or System Service Tools (SST) to find system reference codes for logical partitions.

The product activity log (PAL) allows you to display or print system, Licensed Internal Code, software components, and I/O device data that has been logged.

It also provides data summaries, displays reference code descriptions, allows you to work with removable media statistics, and allows data to be sorted.

Most SRCs display in the PAL for the logical partition that caused the SRC to appear. However, some SRCs may only appear in the PAL for the primary partition since it has the controlling authority over all other partitions. For example, SRCs resulting from processor or main storage problems appear in the PAL of the primary partition.

You can view the product activity log (PAL) from Dedicated Service Tools (DST) or System Service Tools (SST) in the desired partition:

- From DST, perform the following steps:
 1. Select option 7 (Start a service tool).
 2. Select option 6 (Product Activity Log).
- From SST, perform the following steps:
 1. Select option 1 (Start a service tool).
 2. Select option 1 (Product Activity Log).

Attention: Make sure that you choose to display *ALL entries.

Related concepts

“How logical partitioning works” on page 2

Understand the meaning of a logical partitioned system and how primary and secondary partitions operate as independent servers.

“Logical partition concept: IOP” on page 10

The IOP attaches to the system I/O bus and one or more input/output adapters (IOAs). The IOP processes instructions from the server and works with the IOAs to control the I/O devices.

“Logical partition concept: Processor” on page 12

A processor is a device that executes programmed instructions.

“System reference codes (SRCs) for logical partitions” on page 107

Understand how to determine whether your server has run into any logical partitioning errors.

“Resolve system reference codes for logical partitions” on page 111

Find a list of common system reference codes and a suggested corrective action for logical partitions.

“System reference codes (SRCs) for logical partitions” on page 92

Find a list that contains the common SRCs that the PAL can report.

“Logical partition concept: memory” on page 15

Processors use memory to temporarily hold information.

Communications Management

Related tasks

“Logical partition error messages and reports” on page 112

Obtain a list of error messages specific to logical partitions.

“Clear partition configuration data from nonconfigured disk units” on page 131

When you move disk units among logical partitions or servers, you may need to erase any old configuration data before the server can use the logical partition again.

“Accept a disk unit as load source for a logical partition” on page 133

Find system reference codes for each logical partition

Use iSeries Navigator to find the most recent system reference codes for each logical partition on your server.

Each logical partition on your system displays its own set of SRCs. Remember each partition is operating as an independent system and generating its own set of SRCs.

To display system reference code history for a logical partition using My Connections, follow these steps:

1. In iSeries Navigator, expand **My Connections** or your active environment.
2. Select the primary partition of the system.
3. Expand **Configuration and Service** and select **Logical Partitions**.
4. Right-click the **Logical Partition** and select **Properties**.
5. Select the **Reference Code** page to view a list of the 200 most recent system reference codes.
6. Click **Help** if you need more information on this field.
7. Click **OK**.

To display system reference code history for a logical partition using the service tools window, follow these steps:

1. In iSeries Navigator, select **My Connections** or your active environment.
2. Select **Open iSeries Navigator service tools window** in the Taskpad window. If the Taskpad window is not displayed, select **View** and select **Taskpad**.
3. Enter the **IP address** of the service tool network interface to which you want to connect. Click **OK**.
4. You will be prompted for your **Service Tools User ID and user password**.
5. Expand the system name select **Logical Partitions**.
6. Right-click the logical partition and select **Properties**.
7. Select the **Reference Code** page to view a list of the 200 most recent system reference codes.
8. Click **Help** if you need more information on this field.
9. Click **OK**.

To display the reference codes for each logical partition, follow these steps:

1. In iSeries Navigator, expand **Management Central**.
2. Expand **Systems with Partitions**.
3. Select the physical system that has the logical partition with which you want to work.
4. Right-click the logical partition and select **Properties**.
5. Select the **Reference Code** page to view a list of the 200 most recent system reference codes.
6. Click **Help** if you need more information on this field.
7. Click **OK**.

This panel displays a list of the last 200 system reference codes sorted by date and time and from newest to oldest.

Related concepts

“Resolve system reference codes for logical partitions”

Find a list of common system reference codes and a suggested corrective action for logical partitions.

Resolve system reference codes for logical partitions

Find a list of common system reference codes and a suggested corrective action for logical partitions.

You can also use the Logical partition SRC finder to find answers to logical partition problems that report as SRCs.

If a server with logical partitions experiences a configuration data error, the following indications will occur:

- When you perform a normal mode IPL, the system reference codes 1 A600 5090 and 3 0026 0000 display on the control panel. Restart the server by using a manual mode IPL. Check the product activity log (PAL) for specific SRCs.
- When you perform a manual mode IPL, the following messages appear:
- The message Unit has incorrect logical partition configuration appears instead of the sign-on display for dedicated service tools (DST).
- The message Configuration data errors detected - see Product Activity Log appears at the bottom of the Work with System Partitions display.

Check the product activity log for specific system reference codes (SRCs).

Related concepts

“System reference codes (SRCs) for logical partitions” on page 107

Understand how to determine whether your server has run into any logical partitioning errors.

“Restart and power down a system with logical partitions” on page 84

Understand how to safely restart and power down a system with logical partitions.

Related tasks

“Find system reference codes for each logical partition” on page 110

Use iSeries Navigator to find the most recent system reference codes for each logical partition on your server.

“View the Product Activity Log (PAL) for logical partitions” on page 109

Use Dedicated Service Tools (DST) or System Service Tools (SST) to find system reference codes for logical partitions.

Related information

Logical partition system reference code (SRC) finder

Logical partition error messages and reports

Obtain a list of error messages specific to logical partitions.

If the server experiences logical partition errors, it will notify you in one of the following ways:

- An error message is displayed at the bottom of the display screen.
- The Logical Partitioning Error Report display screen is displayed on the system console.

Logical partition error messages at the bottom of the display screen

This list contains error messages that are specific to the logical partitions green screen interface. These messages generally appear near the bottom of the display screen.

The following information lists each error message and a reason why the error occurred. Recovery actions, if appropriate, are included.

A console resource must be selected before an alternate console resource

You need to select the main console resource before you can proceed with selecting the alternate console resource. Main and alternate consoles can be the same resource.

Accept load source disk unit failed

An internal error has occurred in the logical partition configuration manager during a configuration data recovery action. Contact your service provider.

Accept load source disk unit failed - no data found

No logical partition configuration data exists. No one has altered the server yet by removing resources from the primary partition and assigning them to new secondary partitions. The server did not perform the requested action.

Accept load source disk unit not performed - data not protected

The server does not detect a problem with the logical partition configuration data saved on this partition's load source disk unit. There is no reason to perform the accept operation.

Activate remote service failed

The panel task has experienced a failure. Try the request again. If it continues to fail, contact your service provider.

Add I/O resource failed

An internal error occurred. The server did not find the IOP you are adding as an available resource. It is not currently allocated to the relevant partition. Contact your service provider.

Adjust configuration values when changing to i5/OS

This message is informational only.

Alternate console IOP selection failed

An internal error occurred. The server could not correlate the IOP with the list of resources that are assigned to the partition. Check the Licensed Internal Code logs for a 0C00 C9FF entry.

Alternate console IOP selection successful, no console IOP selected yet

This is a warning message. You need to select the console IOP for this partition. For more help, contact your service provider.

Alternate IPL IOP selection failed

An internal error occurred. The server could not correlate the IOP with the list of resources assigned to the partition. Check the Licensed Internal Code logs for a 0C00 C9FF entry.

Alternate IPL IOP selection successful, but optical not supported

You have successfully selected an alternate IPL IOP for a secondary partition. That kind of resource does not support optical devices. A tape device might be available for use.

Alternate IPL IOP selection successful, but tape not supported

You have successfully selected an alternate IPL IOP for a secondary partition. That kind of resource does not support tape devices. A CD-ROM device might be available for use.

Bus xxx already allocated

The partition is already using the bus. If you want to change the ownership type of the bus, select option 5 (Change bus ownership type) from the Work with Partition Configuration display screen.

Bus xxx not allocated

You cannot remove or change the bus. Or you cannot add the IOP since the partition does not currently own the bus. No other logical partition currently owns the bus.

Bus xxx not available

Another partition already owns the bus in shared mode that you attempted to add. You can choose to use the bus instead of own the bus.

Bus xxx ownership type cannot be changed

The bus is a special type that prevents it from being changed to shared. The virtual OptiConnect bus or the primary bus that contains the service processor falls into this category.

Bus requires allocation

A partition must own the bus before another partition can use it in shared mode. Add the bus to a partition with the status of own shared before attempting to use it in another partition.

Bus xxx requires an owner

Before you can select the IOP, you need to assign the bus to a partition.

Cannot change bus xxx ownership while it is in use by another partition

Cannot change the status of the bus while it is in use by another partition. Remove usage of the bus before proceeding with the current requested action.

Cannot perform requested panel function 22 during system MSD IPL

This partition is currently going through a main storage dump. You cannot do another one yet.

Cannot perform requested panel function at this time

The server is performing internal processing (such as an early-stage IPL of a secondary partition) and cannot accept the requested panel function. Try the request again at a later time.

Cannot perform requested panel function, partition must be in manual mode

This error will occur if you attempt to use option 10 on the Work with Partition Status display screen on a partition that is not set to manual mode. To perform option 10, first set the partition to manual mode and restart the partition.

Cannot perform requested panel function while system is in secure mode

This error will occur if you attempt to use panel functions on the Work with Partition Status display screen on a secondary partition set to secure mode. When a secondary partition is set to secure mode, you can only perform its panel functions from the primary partition Work with Partition Status display screen from a DST console. When you change a secondary partition mode from secure to another mode, you can use panel functions on that secondary partition.

Cannot use reserved primary partition name

You tried to use the word "PRIMARY" for the name of a secondary partition. This name is reserved for the primary partition only. Enter a different name.

Change bus ownership type failed

The information on the server indicates that the partition does not own or use the bus, so the change ownership type has failed. Refresh the list of resources by exiting and entering the screen again. Try the request again if logical partition really owns or uses the bus. If the request fails again, contact your service provider.

Change operating environment failed - partition must be powered off.

Some logical partition actions require a partition to be powered on or off.

Change operating environment was cancelled.

A user manually cancelled the change to the operating environment. This message is informational only.

Change operating environment was successful.

This message is informational only.

Change successful, but SLIC release does not support shared processors.

This function is not supported for one of the following reasons: The version or release of the operating system does not support this function or the installed guest operating system does not support this function.

Clear configuration data failed

An internal error has occurred in the logical partition configuration manager during a configuration data recovery action. Contact your service provider.

Clear configuration data failed - no data found

No logical partition configuration data exists. No one has altered the server yet by removing resources from the primary and assigning them to new secondary partitions. The server did not perform the requested action.

Clear non-configured disk unit configuration data failed

An internal error has occurred in the logical partition configuration manager during a configuration data recovery action. Contact your service provider.

Clear non-configured disk unit configuration data failed - no data found

No logical partition configuration data exists. No one has altered the server yet by removing resources from the primary and assigning them to new secondary partitions, or the disk unit does not contain any configuration data. The server did not perform the requested action.

Clear non-reporting logical partitioning resources failed

An internal error has occurred in the logical partition configuration manager during a configuration data recovery action. Contact your service provider.

Clear non-reporting resources failed - no data found

No logical partition configuration data exists. No one has altered the server yet by removing resources from the primary partition and assigning them to new secondary partitions. The server did not perform the requested action.

Clear non-reporting resources not performed - data protected

The server detected logical partition configuration data problems, so the copy operation cannot proceed. You must perform some other recovery action first.

Clear reference code history failed

Try the task again. If it continues to fail, contact your service provider.

Configuration change successful, but partition will not be functional

The server will allow changes made to the logical partition. However, the logical partition might not restart successfully since it does not meet minimum requirements for processors, main storage, or interactive performance. Add the required resources before restarting the partition.

Configuration data changed during request, try again.

The configuration of the partitions has changed while you were making your request. Wait five minutes and retry the operation. The partition might be restarting or might be finishing its restart process.

Configuration data errors detected - see Product Activity Log

The logical partition configuration data is protected and cannot be changed until you take corrective action. See the product activity log (PAL) for information. Typically, you must use an option on the Recover Configuration Data display screen to correct the problem.

Configuration data found that is newer

The server found logical partition configuration data on other disk units. The data is newer than the data on this partition's load source disk unit. No other action required.

Configuration data found that is older

The server found logical partition configuration data on other disk units. The data is older than the data on this partition's load source disk unit. No other action required.

Configuration data found that originated from another partition

The server found logical partition configuration data on other disk units. The server has determined that the configuration data originated on another partition. Clear the configuration data for the disk units which are not configured before using them.

Configuration data found that originated from another system

The server found logical partition configuration data on other disk units. The server has determined that the configuration data originated on another server. Clear the configuration data for the disk units that are not configured before using them.

Console IOP selection failed

An internal error occurred. The server could not correlate the I/O processor (IOP) with the list of resources assigned to the partition. Check the Licensed Internal Code logs for a 0C00 C9FF entry.

Control panel read failed

Try the task again. If it continues to fail, contact your service provider.

Control panel task failed

The virtual service processor task has failed. The use of control panel functions for secondary partitions might not work from the primary partition. Contact your service provider.

Control panel update failed

An internal error occurred that caused the panel request to fail. Try again and if the condition persists contact your service provider. There might be a 0C00 C9FF Licensed Internal Code log.

Copy configuration data to other side failed

An internal error has occurred in the logical partition configuration manager during a configuration data recovery action. Contact your service provider.

Copy configuration data to other side failed - data not valid

This copy of the logical partition configuration data is corrupt or wrong. Try restarting the partition using the other IPL source. If successful, use this function to copy that configuration data to this IPL source. If you cannot fix the problem, contact your service provider.

Copy configuration data to other side failed - no data found

No logical partition configuration data exists. No one has altered the server yet by removing resources from the primary partition and assigning them to new secondary partitions. The server did not perform the requested action.

Copy configuration data to other side not performed - data protected

The server has detected logical partition configuration data problems, so the copy operation cannot proceed. Some other recovery action must be performed first.

Could not start a service tool

A service function could not be started from the Use Dedicated Service Tools menu. If you are attempting to work with server partitions, this error indicates that another user in the same logical partition is currently working with server partitions using SST.

CPM or MSD IPL retry failed

The panel task has experienced a failure. Try the request again. If it continues to fail, contact your service provider.

Data may be incomplete until all partitions are IPLed

The service function has checked if secondary partitions that are represented on the screen where this message is displayed are all powered on and able to report resources such as I/O adapters

and devices. The logical partition configuration manager does not track these types of resources in general. You might only see buses and I/O processors until the partitions are activated.

Data may be incomplete until partition is IPLed

The logical partition is in a state (powered off, for example) where the logical partition configuration manager cannot know for sure what resources are attached to the bus or buses owned or used by the partition. It is possible some resources have physically moved since the last time the partition restarted successfully. This message is informational. It indicates that the server will not display I/O adapters and devices until you restart the logical partition. Bus resources might have been moved since that last restart.

Data recovery will not be allowed, return code: xxxxxxxx

This message is displayed when the server experiences an error during a configuration data recovery process. Contact your service provider.

Deactivate remote service failed

The panel task has experienced a failure. Try the request again. If it continues to fail, contact your service provider.

Default electronic customer support IOP selection failed

An internal error occurred. The server could not correlate the IOP with the list of resources assigned to the partition. Check the Licensed Internal Code logs for a 0C00 C9FF entry.

Delete failed - one or more partitions currently use the shared pool.

This action is not allowed because there are active secondary partitions using the shared processor pool.

Detailed report does not exist for the problem

This problem does not have any detailed information about it. No other action is required.

Disk unit IOP reset/reload failed

The panel task has experienced a failure. Try the request again. If it continues to fail, contact your service provider.

Display processor status failed, no processors are owned by partition

The selected partition does not have any processors. The requested option cannot be performed.

DST console session required to use panel function while in secure mode

This error occurs in SST when you select a function that must be performed in DST. Use the DST display screen to perform this function.

Dump MFIOP failed.

The request to dump the MFIOP failed. Check the product activity log for errors associated with the MFIOP resource and report the errors to your service provider.

Dump MFIOP was successful.

You have successfully dumped the MFIOP.

Electronic customer support IOP selection successful, async not supported

You have successfully selected a default electronic customer support IOP for a secondary partition. Beware that the asynchronous communications protocol is not supported by that kind of resource.

Electronic customer support IOP selection successful, SDLC not supported

You have successfully selected a default electronic customer support IOP for a secondary partition. Beware that the SDLC communications protocol is not supported by that kind of resource.

Enter value for shared processor pool units.

Set the value for the shared processor pool units.

Force DST failed

The panel task has experienced a failure. Try the request again. If it continues to fail, contact your service provider.

Function not allowed during system MSD IPL.

This partition is currently going through a main storage dump. You cannot perform the requested functions at this time.

Function not available due to version/release level of primary partition

The function you tried to perform in the secondary partition is not possible because the primary partition has an earlier version of the operating system. The primary partition must be at the same level or a higher level for you to be able to use this function.

Function not supported in SST, use DST console

The function you tried to perform is only allowed from DST because of the greater security for DST. Start DST and try the function again.

Highest number allowed for partition identifier: xx

This error occurs when you try to give the partition an identifier that is greater than what the server allows. Enter a number that is less than or equal to the highest allowed number.

Incorrect key pressed

An invalid key was pressed. Press a valid function key for this display screen.

Incorrect resource type selected

You made a request that is not supported by the type of resource you selected. Depending on the display screen where the error message is displayed, you might need to select a bus, an IOP, or both.

Interactive feature decreased to xxx % based on number of processors

This is an informational message that the system has adjusted the value. Verify the value and press Enter to accept it. No other action is required.

Interactive feature increased to xxx % based on number of processors

This is an informational message that the system has adjusted the value. Verify the value and press Enter to accept it. No other action is required.

Interactive feature percentage entered is not valid

You entered a value that was greater than 100 % or that was not an integer. Enter a value between 1% and 100% for the partition.

Interactive feature percentage not within minimum and maximum range

You tried to change the value for interactive performance in this partition. However, the value you entered is not between the minimum and maximum values. Either enter a number that is between the minimum and maximum values, or change the minimum and maximum values.

IOP cannot be added or removed due to IOP type

The server cannot add or remove the I/O processor because it is:

- Attached to the virtual bus used for OptiConnect.
- Attached to a bus that is used in a clustered environment.
- The IOP that is used for the primary partition load source or console.

IOP option must match bus option specified

Due to the nature of the request, a bus and an attached IOP cannot have conflicting options taken against them.

IOP selected lacks capabilities to support requested function

When resource capability is being filtered on a tagged resource selection screen this message will appear if the server determines that the resource cannot support the requested capability selection. Tagged resources are ones that have special meaning for secondary partitions, such as the load source IOP or console IOP. Press F9 on the selection displays to turn filtering off. This will allow the selection if you still want to use the resource.

I/O resources differ from system, adjust configuration after recovery

This is a warning message. Some resources in the server are not originally part of the configuration. Perform recovery actions for the partition configuration data.

Insufficient available shared processor units.

You have tried to set the number of shared processor units to a number greater than is available in the shared processor pool. Possible solutions are to add more processors to the shared processing pool or to reduce the number of shared processor units to be less than or equal to the number of available shared processors units.

IPL restart failed

The panel task has experienced a failure. Try the request again. If it continues to fail, contact your service provider.

Load source and console IOPs will be required to continue with create

There are no available IOPs to add to this partition. Go back and remove the required IOPs from another partition that does not need them, then continue with creating this partition.

Load source IOP selection failed

An internal error occurred. The server could not correlate the IOP with the list of resources assigned to the partition. Check the Licensed Internal Code logs for a 0C00 C9FF entry.

Logical partitioning configuration data error detected

Logical partition configuration manager checksum failed. You cannot trust the configuration data to be valid. Contact your service provider.

Logical partitioning configuration data is not valid

Logical partition configuration management did not detect logical partition data on the current IPL source of the load source disk unit (source A or source B). Contact your service provider.

Logical partitioning configuration data not found

No logical partition configuration data exists. No one has altered the server yet by removing resources from the primary partition and assigning them to new secondary partitions. The server did not perform the requested action.

The logical partition API has been deprecated on physical system

The logical partition configuration functionality for this system is available from the Hardware Management Console. See the logical partitioning information in the IBM Systems Hardware Information Center.

Make a valid selection

You entered input that is not valid for this selection. Enter valid input for this selection.

Maximum interactive performance set to xxx % based on maximum processors

The server has 100% interactive performance available to split between partitions. However, the allowable ranges for each partition depend on how the server processors are split. For example, if one partition has only 10% of the server's processors, then it would not be possible for that partition to use 99% of the interactive performance available to the server. These error messages will appear when the interactive performance settings are outside of a practical range, and the server has made the adjustment for you.

Maximum processor pool units above what maximum processors can support.

You have tried to set the amount of processing units to a number greater than the maximum processors can support. A possible solution is to reduce the maximum amount of processing units requested.

Maximum processor units set to xxx based on maximum processors.

The maximum processor units were adjusted based on the maximum processors specified. The adjusted value is different than what was specified to satisfy the maximum processor units supported per processor.

Maximum value entered is not valid

The value you entered is incorrect. Either it is greater than what this server allows, or it is not an integer. Enter a different value.

Minimum interactive feature set to xxx % based on minimum processors

The server has 100% interactive performance available to split between partitions. However, the allowable ranges for each partition depend on how the server processors are split. For example, if one partition has 90% of the server's processors, then it would not be possible for that partition to use 1% of the interactive performance available to the server. These error messages will appear when the interactive performance settings are outside of a practical range, and the server has made the adjustment for you.

Minimum processor pool units below what minimum processors can support.

You have tried to set the amount of processing units to a number less than the minimum processors can support. A possible solution is to increase the amount of processing units requested.

Minimum processor units set to xxx based on minimum processors.

The minimum processor units were adjusted based on the minimum processors specified. The adjusted value is different than what was specified to satisfy the minimum processor units supported per processor.

Minimum value cannot be greater than the maximum value

The value you specified for the minimum is greater than the value for the maximum. Either make the maximum value greater or enter a value for the minimum that is less than the current maximum.

Minimum value entered is not valid

The value you entered is incorrect. Either it is less than what this server allows, or it is not an integer. Enter a different value.

Multiple interactive feature values adjusted based on processor values

This is an informational message that the system has adjusted the values. Verify the values and press Enter to accept them. No other action is required.

New interactive performance percentage entered is greater than available

Not enough interactive performance is available to allow you to add the amount that you requested. Either add less interactive performance or free the interactive performance from another partition.

New number of processors entered is greater than available

Not enough processors are available to allow you to add the amount that you requested. Either add fewer processors or free processors from another partition.

New partition name entered is not valid

The partition name must conform to the following rules: Characters can be any letter (A-Z) and any number (0 - 9). Name cannot be all blanks. Name cannot be PRIMARY. Name cannot be the same as an existing secondary partition.

New partition name entered is not valid - name already exists

The name you entered for this partition is already being used by another partition on the server. Enter a different name for this partition.

New size of main storage entered is greater than available

Not enough main storage is available to allow you to add the amount that you requested. Either add less main storage or free the main storage needed from another partition.

No alternate IPL device is currently attached to IOP selected

This is a warning message. The server cannot identify any alternate IPL devices attached to this IOP. If no devices are attached, make sure you attach one before trying to use the IOP in a partition.

No change made, the new name is the same as the existing name

This is an informational message. You choose to change the name of the partition. However, the name you selected is the same as it was previously. No other action is required.

No console device is currently attached to IOP selected

This is a warning message. The server cannot identify any console devices attached to this IOP. If no devices are attached, make sure that you attach one before trying to use the IOP in a partition.

No electronic customer support resource is attached to IOP selected

This is a warning message. The server cannot identify any electronic customer support devices attached to this IOP. If no devices are attached, make sure that you attach one before trying to use the IOP in a partition.

No guest partitions defined.

This is informational only.

No load source capable disk unit is currently attached to IOP selected

This is a warning message. The server cannot identify any load source disk units attached to this IOP. If no devices are attached, make sure that you attach one before trying to use the IOP in a partition.

No non-configured disk units found that have configuration data

This message is displayed on the Select Non-Configured Disk Unit for Configuration Data Clear display screen. The disk units you selected do not contain any partition configuration data.

No service printer specified. Print request failed

This message is displayed in DST or SST when you do not select a printer and exit the prompt. If you meant to select a printer, try the request again.

Not able to start Work with system partitions

This message is displayed in SST and indicates that another user on the server is currently working with logical partitions in either DST or SST.

Not enough interactive performance percentage available

You requested to add more interactive performance than is available. Either add less interactive performance or remove what you need from other partitions.

Not enough main storage available

You requested to add more main storage than is available. Either add less main storage or remove what you need from other partitions.

Not enough processors available

You requested to add more processors than are available. Either add fewer processors or remove what you need from other partitions.

Not enough processors available.

There are not enough available processors to complete your request. Reduce the number of processors being requested.

Not enough shared pool processor units available.

You tried to set the amount of shared processor units to a number greater than is available. Possible solutions are to add more processors to the shared pool or to reduce the amount of processor units requested to be less than or equal to the amount of processors units that are available.

Number entered is too small - less than required by using partitions.

The shared processor pool requires more processors than the number you entered. Enter a greater number of processors to complete the request. The shared processor pool must have enough processors to support the greatest number of processors of all the partitions using the shared processor pool.

Number of processors allocated to pool changed successfully.

This message is informational only.

Number of processors entered is greater than available.

You tried to move more processors than are available. Reduce the number of processors to move.

Number of processors not within minimum and maximum range

You tried to change the value for processors in this partition. However, the value you entered is not between the minimum and maximum values. Either enter a number that is between the minimum and maximum values, or change the minimum and maximum values.

Number of processors entered is not valid

The value you entered is incorrect. Either it is less than or greater than what is allowed for this server or it is not an integer. Enter a different value.

Number of shared processor units not within minimum and maximum range.

The number of processing units must be greater than or equal to the minimum and less than or equal to the maximum shared processor units.

Only one partition may be selected

You tried to perform an action on more than one partition. This display screen can only handle one request at a time. Repeat the action separately for each partition.

Only one resource may be selected

You tried to perform an action on more than one resource. This display screen can only handle one request at a time. Repeat the action separately for each resource.

Only one resource of a specific type may be selected

You tried to perform an action on more than one type of resource. This display screen can only handle one request at a time for each type of resource. Repeat the action separately for each type of resource.

Option is allowed only from primary partition

You can perform options 13 and 14 to change the System IPL Action from the primary partition. The server does not allow the displaying or changing of that value in secondary partitions. Or the secondary partition is in secure mode. You must therefore go to the primary DST console to change the mode to a value other than secure mode.

Option not allowed during system MSD IPL

When the server is performing a main storage dump (MSD), you cannot perform many of the logical partition configuration options that alter the logical partition configuration data. For example, you cannot perform recovery actions or create a new secondary partition.

Option not allowed for new partition until next system IPL

This partition was recently created. You cannot perform any actions from it until after you restart the server. When you restart the server, you can attempt this option.

Option not allowed for primary partition

Some options do not make sense when issued against the primary partition. For example you cannot change the primary partition's name, delete the primary partition, or select a tagged secondary resource like a load source IOP or a console IOP.

Option not allowed for resource chosen

The option you entered is not valid on this display screen. See the display screen for a list of allowed options.

Option not allowed while partition is in secure mode, use primary DST

This error will occur if you attempt to use panel functions on the Work with Partition Status display screen on a partition set to secure mode. When a partition is set to secure mode, you can only perform its panel functions from the primary partition Work with Partition Status display screen from a DST console. When you change a partition mode from secure to another mode, you can use panel functions on that secondary partition.

Option is only allowed for the primary partition.

Some actions are not allowed for a secondary partitions. For example, configuration changes cannot be made from a secondary partition.

Panel function failed - keylock is not in control panel

The key for the server is not in the control panel. Insert the key and try the request again.

Partition already powered off

You selected to power off this partition. However, the partition is already off.

Partition already powered on

You selected to power on this partition. However, the partition is already on.

Partition create failed - maximum number of partitions already exist

The server already has the maximum allowed number of logical partitions allowed for the release. You cannot create another one.

Partition create failed - not enough system resources available

You cannot create another partition. The maximum number of partitions that this server supports have already been created.

Partition delete failed - partition must be powered off

You cannot delete a partition while it is still powered on. Power off the partition, then perform the delete operation for that partition.

Partition does not currently own the bus.

The action cannot be performed because no other logical partition owns the bus. You must assign ownership of this bus before you can do the following:

- Remove the bus.
- Change the bus.
- Move an I/O processor.

Partition identifier entered is already in use by another partition

This error occurs when you try to give the partition an identifier that is already used by another partition on the server. Enter a different identifier.

Partition identifier entered is not valid

You entered an identifier that was not between 1 and 24 or that was not an integer. Enter a value that is between 1 and 24.

Partition install might be needed after recovery due to version/release level

This is a warning message. The system found what seems to be an unsupported software version in one of the secondary partitions. The identified release cannot support the current server hardware. If the secondary partition does have an unsupported release, install a supported i5/OS version after you finish recovering the primary partition.

Partition xxx create successful, but partition will not be functional.

The server allowed the changes to the logical partition. However, the logical partition might not restart successfully since it does not meet one or more of the minimum requirements for processors, memory, or interactive performance. Add the required resources before restarting the partition.

Power off domain failed

The panel task has experienced a failure. Try the request again. If it continues to fail, contact your service provider.

Power on domain failed

The panel task has experienced a failure. Try the request again. If it continues to fail, contact your service provider.

Primary partition configuration data recovery failed

An internal error has occurred in the logical partition configuration manager during a configuration data recovery action. Contact your service provider.

Primary partition configuration data recovery failed - no data found

No logical partition configuration data exists. No one has altered server yet by removing resources from the primary partition and assigning them to new secondary partitions. The server did not perform the requested action.

Primary partition configuration data recovery failed - no new data found

No further action is necessary. The server did not find any logical partition configuration data on other disk units that is different than what is currently saved on this partition's load source disk unit.

Print request failed with unknown error

An unknown error has occurred. Contact your service provider.

Print request not submitted, no entries listed to print

You tried to send a print request without selecting anything to print, or, this display screen does not allow printing. Try to print from a display screen that allows you to select entries.

Print request submitted to service printer with one or more errors

This is an informational error. Although the print request had some errors, the print request was successful. You might want to contact your service provider to determine the nature of the problem.

Problem resolution failed

A problem selected to be accepted is not currently in the list of known problems for the logical partition, or another internal error occurred. Contact your service representative.

Problem resolution failed, unable to clear attention errors

A problem selected to be accepted is not currently in the list of known problems for the logical partition, or another internal error occurred. Contact your service representative.

Problem resolution failed, unable to clear informational errors

A problem selected to be accepted is not currently in the list of known problems for the logical partition, or another internal error occurred. Contact your service representative.

Problem resolution failed, unable to clear severe errors

A problem selected to be accepted is not currently in the list of known problems for the partition, or another internal error occurred. Contact your service representative.

Remove I/O resource failed

An internal error occurred. The server did not find that the IOP is currently owned by the relevant partition and is not already an available resource. Contact your service provider.

Reorder SPCN addressing was successful.

This message is informational only.

Requested panel function not currently enabled

The server has not enabled the panel function at this time. Wait and try the request again. For instance, if panel function 21 is attempted against a partition that is restarting and not quite to dedicated service tools (DST) yet, then 21 will not be enabled until DST is reached.

Request failed, bus xxx not in use

The partition does not currently use the bus, so it cannot own it.

Request failed, bus xxx not shared

The bus is in a special state that prevents it from being changed to shared (such as being used in a cluster). Or, the IOP being removed does not belong to a bus that is in shared mode.

Request failed, configuration data protected - see Product Activity Log

The logical partition configuration data is protected for some reason, and cannot be changed until

corrective action is taken. See the product activity log (PAL) for information about what action to take. Typically, you must use an option on the Recover Configuration Data display screen to correct the problem.

Request failed due to the state of one or more partitions

Depending on the requested function, either all the secondary partitions must be powered off or powered on to continue.

Request failed, errors reported were not handled

An error report screen was previously displayed and either the user canceled without allowing the server to recover from the problems listed or the server failed to perform the recovery action.

Request failed, return code: xxxxxxxx

This message will appear for an error that does not have a message description associated with it. The hex return code will tell you what has happened.

0xFFFFF98

The I/O configuration has changed while the current action was being performed. Depending on the display screen you were on resources might refresh automatically. If so just retry the request. You might have to exit and enter the display screen again to retry the request.

Request is not allowed for the partition.

You attempted a request that is not allowed for this partition. Some actions are not allowed on the primary partition. For example, you cannot delete the primary partition or remove the primary partition's load source I/O processor.

Request failed, more processors specified than are in shared pool.

You tried to set the amount of processors to a number greater than is available in the shared processor pool. Possible solutions are to add more processors to the shared pool or reduce the amount of processors requested to be less than or equal to the amount of processors that is available.

Request failed - see Product Activity Log

An internal error has occurred in the logical partition configuration manager during a configuration change request. See the product activity log (PAL) for information. Contact your service provider.

Resources requested greater than is allocated to the partition

The partition might have been restarted with fewer processors, main storage, or interactive performance than requested (but within the minimum allowable limit). The attempt to remove these resources exceeds what the partition is currently using.

Size of main storage entered is not valid

The value you entered for the main storage is not a valid integer. Enter an integer.

Size of main storage not within minimum and maximum range

You tried to change the value for main storage in this partition. However, the value you entered is not between the minimum and maximum values. Either enter a number that is between the minimum and maximum values, or change the minimum and maximum values.

Shared processor pool create was successful.

This message is informational only.

Shared processor pool delete was successful.

This message is informational only.

Shared processor pool units above maximum processor capacity.

You have set the amount of processing units to be more than the maximum processor capacity. A possible solution is to reduce the amount of processing units you are requesting to be less than or equal to the amount the current processors can support. Each processor can support a maximum of 1.00 processing units.

Shared processor pool unit allocation entered is not valid.

The value you entered is incorrect. Either it is greater than or less than what the shared pool allows. Enter a different value.

Shared processor pool units below minimum processor capacity.

You have set the amount of processing units to be less than the minimum processor capacity. A possible solution is to increase the amount of processing units you are requesting.

Shared processor pool units greater than processors can support.

You have specified processing units greater than the processors can support. Possible solutions are use more processors or reduce the number of processor units.

Smallest minimum main storage size is xxxxxxxx for maximum entered

The server must enforce a range of reasonable values for the minimum and maximum main storage values relative to each other. This is because a certain amount of fixed storage is allocated for server use based on the maximum size specified. The fixed storage required by the server cannot be smaller than the minimum value specified. Adjust your minimum value to be at least as large as the value in the message. Or, adjust the maximum size to some value that is smaller.

Storage I/O adapter cannot be assigned to a guest partition when a controlling I/O processor exists.

An I/O Adapter used by a guest partition is located in a card position on the same Multi-adapter bridge domain as an I/O Processor. Guest partition data might be lost if any of the following occur:

- A primary partition Type D IPL is performed.
- The I/O Adapter is moved to an i5/OS partition.
- An error causes the Logical partition (LPAR) configuration data to not be used.

Use the LPAR Validation Tool (LVT)



to create a valid LPAR configuration.

System IPL required to activate changes

Changes have been made to the logical partition configuration that require a server restart to activate. Examples are partition create, delete, recovery, bus ownership type change, or changing the primary partition's processors, main storage, or interactive performance values.

Unit has incorrect logical partition configuration

The logical partition configuration data is protected for some reason, and cannot be changed until corrective action is taken. See the product activity log (PAL) for information about what action to take. Typically, you must use an option on the Recover Configuration Data display screen to correct the problem.

Unknown error in service function

An unexpected condition occurred in the licensed code that either manages the logical partition configuration data or the logical partition service function. Check the Licensed Internal Code logs for a 0C00 C9FF entry. Contact your service provider.

Update configuration data failed

An internal error has occurred in the logical partition configuration manager during a configuration data recovery action. Contact your service provider.

Update configuration data failed - no data found

No logical partition configuration data exists. The server has not been altered yet by removing resources from the primary and assigning them to new secondary partitions. The server did not perform the requested action.

Value entered for Level of detail is not valid

The value you supplied for this field is incorrect. Enter a valid value for the Level of detail.

Value entered for Number of reference codes is not valid

The value you supplied for this field is incorrect. Enter a valid value for the Number of reference codes.

Value entered for Secondary partition(s) is not valid

The value you supplied for this field is incorrect. Enter a valid value for the Secondary partition.

Value entered for System partition(s) is not valid

The value you supplied for this field is incorrect. Enter a valid value for the System partition.

Logical partition error messages in the error report

When the logical partitioning configuration manager must report multiple errors, the Logical Partitioning Error Report display screen is displayed. This display screen contains a summary of errors with details available by using option 5 on the particular error.

From this display screen, you can cancel the current request and return to the previous display screen by selecting F3 (Exit) or F12 (Cancel). You can also accept the error and continue by selecting option 1 (Accept problem) or F10 (Accept all problems and continue). However, you should fully understand these errors before taking any actions.

The report groups error messages by category as follows:

- **Informational**--A recoverable error occurred that did not prevent the requested operation.
- **Attention**--An error occurred which prevents the requested operation. Details describe the cause of the failure, but do not tell you which operation failed. See any **severe** errors to determine which operation failed.
- **Severe**--An operation could not complete successfully. See any previous **attention** messages to determine reasons for the failed operation.

The following list gives attention message and severe message summaries, why the error might have occurred, and recommended actions.

Bus not removed

A severe message indicating that a bus remove operation failed. Correct previous attention errors listed in the error report and try the operation again.

Bus ownership type change failed

A severe message indicating that a change bus ownership type operation failed. Correct previous attention errors listed in the error report and try the operation again.

Device in use

An attention message indicating that a particular resource is in use by the server, its owning IOP, or bus while someone attempted to remove it from a partition. If this resource is a disk unit, it is recommended that you remove it from its current auxiliary storage pool (ASP) before removing the IOP or bus.

- For all other resources, perform the following steps:
 1. Write down the logical address of the resource that you need to vary off. You can find this information when you display the allocated resources for the partition.
 2. From i5/OS, use the Work with Configuration Status (WRKCFGSTS) command to find the resource name based on the logical address. From DST, go to Hardware Service Manager.
 3. Vary off any devices or controllers that are active on the resource.

IOP not removed

A severe message indicating that an IOP remove operation failed. Correct previous attention errors listed in the error report and try the operation again.

IOP requires reallocation

An attention message indicating that you attempted to change bus ownership type from shared

to dedicated. However the bus contains IOPs currently unassigned to any logical partition. Add I/O resources to assign the available IOPs to the same partition as the bus owner. Then, repeat the change of bus ownership type.

I/O resource not updated

A severe message indicating that an I/O resource could not be updated in the configuration data. Correct previous attention errors listed in the error report and try the operation again.

State of IOP is unknown

An attention message indicating a particular IOP cannot be located in the partition from which it is being removed.

If the owning partition is currently powered off, you can ignore this error if you know the IOP and its resources are available. If the owning partition is currently powered on, this error might indicate that the owning IOP was recently added to the partition but is not yet active.

Wait five minutes and retry the operation. If the failure persists or if the IOP was not recently added to the owning partition, contact your service representative.

Related concepts

Basic system operations

Backup and Recovery

Related tasks

“View the Product Activity Log (PAL) for logical partitions” on page 109

Use Dedicated Service Tools (DST) or System Service Tools (SST) to find system reference codes for logical partitions.

Work with configuration data for logical partitions

Use DST and SST to clear, copy and update configuration data, to configure nonconfigured disk units, to clear nonreporting resources, to accept a disk unit as a load source, and to delete logical partitions on the server.

You may need to work with logical partition configuration data. Typically, you will need to do so in order to recover from hardware failures, to correct errors, or to perform maintenance after hardware movement.

The server maintains the configuration data for all logical partitions on the load source of each logical partition. The configuration data maintained on the primary partition is considered the master copy. Problems can occur when the configuration information on the primary partition and a secondary partition conflicts, or after you initialize disk units during an installation.

Attention: Use iSeries Navigator and Dedicated Service Tools (DST) to work with configuration data for logical partitions.

Related concepts

Backup and Recovery

Recover logical partition configuration data:

You can use this option to recover logical partition configuration data if one of your secondary partitions is running the i5/OS operating system. This procedure is part of a full server recovery.

The following information applies only to **primary partitions**.

After reinstalling the Licensed Internal Code on the primary partition, you may need to use DST to recover the logical partition configuration data. Complete the following steps to recover logical partition configuration data:

1. Before changing your disk configuration or recovering your user ASPs, select option 11 (Work with system partitions).
2. Select option 4 (Recover configuration data).
3. Select option 1 (Recover primary partition configuration data). The server locates a nonconfigured disk unit that contains the most recent configuration data for your server. If the message No units found with more current configuration data displays instead of a list of resources, then no unassigned disk units contain any appropriate configuration information. Consult a service representative for assistance.
4. Select an appropriate configuration to recover.
5. Confirm your selection by pressing **Enter**.
6. The server copies the new configuration data to the primary partition's load source and automatically restarts the primary partition.
7. When you next perform an initial program load (IPL) for the secondary partitions, the server updates their logical partition configuration data.
8. Once the primary partition completes its IPL, continue with any further recovery steps as outlined in the Recovery section of Backup and Recovery.

Related concepts

"Logical partition concept: load source" on page 22

Each logical partition must have one disk unit designated as the load source.

Backup and Recovery

Save all configuration data:

You can use iSeries Navigator to save logical partition configuration data in a file on your computer. This function is used when all of the secondary partitions on your iSeries are running a guest operating system.

Note: This function does not save guest partition IPL parameters. If you want to save guest partition IPL parameters, you should perform a full system save on the hosting partition.

To save all configuration data using My Connections, follow these steps:

1. In iSeries Navigator, expand **My Connections** or your active environment.
2. Select the primary partition of the system.
3. Expand **Configuration and Service** and select **Logical Partitions**.
4. Right-click the **Logical Partition** and select **Configure Partitions**. You are now working in the Configure Logical Partitions window.
5. Right-click **Physical System** and select **Recovery** and **Save all Configuration Data** . All saved information will be stored in a file on the computer running iSeries Navigator.

To save all configuration data using the service tools window, follow these steps:

1. In iSeries Navigator, select **My Connections** or your active environment.
2. Select **Open iSeries Navigator service tools window** in the Taskpad window. If the Taskpad window is not displayed, select **View** and select **Taskpad**.
3. Enter the **IP address** of the service tool network interface to which you want to connect. Click **OK**.
4. You will be prompted for your **Service Tools User ID and password**.
5. Expand the system name select **Logical Partitions**.
6. Right-click the logical partition and select **Configure Partitions**. You are now working in the Configure Logical Partitions window.
7. Right-click **Physical System** and select **Recovery** and **Save all Configuration Data** . All saved information will be stored in a file on the computer running iSeries Navigator.

To save all configuration data using Management Central, follow these steps:

1. In iSeries Navigator, expand **Management Central**.
2. Expand **Systems with Partitions**.
3. Select the physical system that has the logical partition with which you want to work.
4. Right-click the physical system and select **Configure Partitions**. You are now working in the Configure Logical Partitions window.
5. Right-click **Physical System** and select **Recovery** and **Save all Configuration Data**. All saved information will be stored in a file on the computer running iSeries Navigator.

Related tasks

“Restore all configuration data”

You can use iSeries Navigator to restore all of your configuration data.

Restore all configuration data:

You can use iSeries Navigator to restore all of your configuration data.

This function is used when all of the secondary partitions on your iSeries are running a guest operating system and you have saved the configuration data to a file on the computer running iSeries Navigator. This procedure is part of a full server recovery.

If the configuration data on your server has been cleared, you should use this function to regain access to the saved configuration data created when you completed the task save all configuration data.

To restore all configuration data using My Connections, follow these steps:

1. In iSeries Navigator, expand **My Connections** or your active environment.
2. Select the primary partition of the system.
3. **Configuration and Service** Expand and select **Logical Partitions**.
4. Right-click the **Logical Partition** and select **Configure Partitions**. You are now working in the Configure Logical Partitions window.
5. Right-click **Physical System** and select **Recovery** and **Restore All Configuration Data**.

Once the primary partition completes its restart, continue with any further recovery steps as outlined in the Recovery section of Backup and Recovery. 

To restore all configuration data using the service tools window, follow these steps:

1. In iSeries Navigator, select **My Connections** or your active environment.
2. Select **Open iSeries Navigator service tools window** in the Taskpad window. If the Taskpad window is not displayed, select **View** and select **Taskpad**.
3. Enter the **IP address** of the service tool network interface to which you want to connect. Click **OK**.
4. You will be prompted for your **Service Tools User ID and password**.
5. Expand the system name select **Logical Partitions**.
6. Right-click the logical partition and select **Configure Partitions**. You are now working in the Configure Logical Partitions window.
7. Right-click **Physical System** and select **Recovery** and **Restore All configuration Data**.

Once the primary partition completes its restart, continue with any further recovery steps as outlined in the Recovery section of Backup and Recovery. 

To restore all configuration data using Management Central, follow these steps:

1. In iSeries Navigator, expand **Management Central**.

2. Expand **Systems with Partitions**.
3. Select the physical system that has the logical partition with which you want to work.
4. Right-click the physical system and select **Configure Partitions**. You are now working in the Configure Logical Partitions window.
5. Right-click **Physical System** and select **Recovery and Restore All Configuration Data** .

Once the primary partition completes its restart, continue with any further recovery steps as outlined in the Recovery section of Backup and Recovery. 

Related concepts

Backup and Recovery

Related tasks

“Save all configuration data” on page 128

You can use iSeries Navigator to save logical partition configuration data in a file on your computer. This function is used when all of the secondary partitions on your iSeries are running a guest operating system.

Clear partition configuration data for logical partitions:

You can clear the configuration data for the topics.

Related tasks

“Delete all of your logical partitions” on page 134

There may be a time when you need to erase all your logical partitions to make the server non-partitioned again.

“Clear partition configuration data from nonconfigured disk units” on page 131

When you move disk units among logical partitions or servers, you may need to erase any old configuration data before the server can use the logical partition again.

Update partition configuration data on all logical partitions:

You can update the configuration data for every active logical partition by copying it manually from the primary partition to all active logical partitions.

Attention: You should only perform these steps when instructed to do so by a service representative.

All inactive partitions will update automatically on their next restart.

Attention: Using this function when the configuration data on the primary partition is incorrect ruins your existing configuration.

To update configuration data using My Connections, follow these steps:

1. In iSeries Navigator, expand **My Connections** or your active environment.
2. Select the primary partition of the system.
3. Expand **Configuration and Service** and select **Logical Partitions**.
4. Right-click the **Logical Partition** and select **Configure Partitions**. You are now working in the Configure Logical Partitions window.
5. Right-click **Physical System** and select **Recovery and Update configuration data**.

To update configuration data using the service tools window, follow these steps:

1. In iSeries Navigator, select **My Connections** or your active environment.
2. Select **Open iSeries Navigator service tools window** in the Taskpad window. If the Taskpad window is not displayed, select **View** and select **Taskpad**.

3. Enter the **IP address** of the service tool network interface to which you want to connect. Click **OK**.
4. You will be prompted for your **Service Tools User ID and user password**.
5. Expand the system name select **Logical Partitions**.
6. Right-click the logical partition and select **Configure Partitions**. You are now working in the Configure Logical Partitions window.
7. Right-click **Physical System** and select **Recovery and Update configuration data**.

You can use iSeries Navigator to update logical partition configuration data. To update configuration data using Management Central, follow these steps:

1. In iSeries Navigator, expand **Management Central**.
2. Expand **Systems with Partitions**.
3. Select the physical system from which you would like to update configuration data.
4. Right-click the logical partition and select **Configure Partitions**. You are now working in the Configure Logical Partitions window.
5. Right-click **Physical System** and select **Recovery and Update configuration data**.

Clear partition configuration data from nonconfigured disk units:

When you move disk units among logical partitions or servers, you may need to erase any old configuration data before the server can use the logical partition again.

You need to clear the configuration data when the disk unit has all of the following characteristics:

- A system reference code (SRC) of B600 5311 displays in the product activity log (PAL) against a nonconfigured disk unit.
- It is no longer a load source in its own logical partition.
- It is originally from a different logical partition where it was a load source, or it is from a different server that had logical partitions.

This procedure erases only logical partition data. No system or user data is affected.

Perform this procedure from a dedicated service tools (DST) display:

1. Go to the DST menu.
2. Select option 11 (Work with system partitions).
3. Select option 4 (Recover configuration data).
4. Select option 3 (Clear non-configured disk unit configuration data).
5. Select the disk unit with the configuration data you want to erase. Type a 1 in the Opt field to the left of the disk unit listing.
6. Press the Enter key.
7. Confirm that you truly do want to erase the configuration data.
8. The changes take effect immediately.

Related concepts

“Logical partition concept: load source” on page 22

Each logical partition must have one disk unit designated as the load source.

“Clear partition configuration data for logical partitions” on page 130

You can clear the configuration data for the topics.

“Logical partition concept: disk units” on page 16

Disk units store data. The server can use and reuse this data at any time. It is more permanent than memory, but you can still erase it.

Related tasks

“Install new hardware for logical partitions” on page 83

Understand the rules on installing hardware to a system with logical partitions.

“View the Product Activity Log (PAL) for logical partitions” on page 109

Use Dedicated Service Tools (DST) or System Service Tools (SST) to find system reference codes for logical partitions.

“Accept a disk unit as load source for a logical partition” on page 133

Clear nonreporting resources on logical partitions:

Attention: Do **not** run this procedure if ANY hardware is marked as failed. Only run this procedure when all server hardware is completely operational.

After you add, remove, or move hardware within a server with logical partitions, you may have resources that are no longer available, that are listed twice, or that are no longer on the server.

You can clean up these listings so that all nonreporting resources are erased from the configuration data for the logical partition.

You can use the iSeries Navigator to clear non-reporting logical partition resources. To clear non-reporting logical partitioning resources using My Connections, follow these steps:

1. In iSeries Navigator, expand **My Connections** or your active environment.
2. Select the primary partition of the system.
3. Expand **Configuration and Service** and select **Logical Partitions**.
4. Select the partition from which you would like to clear non-reporting logical partitioning resources.
5. Right-click the **Logical Partition** and select **Configure Partitions**. You are now working in the Configure Logical Partitions window.
6. Right-click **Physical System** and select **Recovery** and **Clear non-reporting partitioning resources**.

To clear non-reporting logical partitioning resources using the service tools window, follow these steps:

1. In iSeries Navigator, select **My Connections** or your active environment.
2. Select **Open iSeries Navigator service tools window** in the Taskpad window. If the Taskpad window is not displayed, select **View** and select **Taskpad**.
3. Enter the **IP address** of the service tool network interface to which you want to connect. Click **OK**.
4. You will be prompted for your **Service Tools User ID and user password**.
5. Expand the system name select **Logical Partitions**.
6. Select the partition from which you would like to clear non-reporting logical partitioning resources.
7. Right-click the logical partition and select **Configure Partitions**. You are now working in the Configure Logical Partitions window.
8. Right-click **Physical System** and select **Recovery** and **Clear non-reporting partitioning resources**.

To clear non-reporting logical partitioning resources using Management Central, follow these steps:

1. In iSeries Navigator, expand **Management Central**.
2. Expand **Systems with Partitions**.
3. Select the physical system that has the logical partition with which you want to work.
4. Select the partition from which you would like to clear non-reporting logical partitioning resources.
5. Right-click the logical partition and select **Configure Partitions**. You are now working in the Configure Logical Partitions window.
6. Right-click **Physical System** and select **Recovery** and **Clear non-reporting partitioning resources**.

Related tasks

“Install new hardware for logical partitions” on page 83
Understand the rules on installing hardware to a system with logical partitions.

Accept a disk unit as load source for a logical partition:

When configuration data on the load source of a logical partition is different from what the server expects, an error displays in the product activity log (PAL). A reference code of B600 5311 occurs against the load source disk unit.

If you have recently moved or added disk units either within the server or from another server, they may still contain configuration data. If you do not want to use one of them as the load source, you need to clear the configuration data before proceeding.

Otherwise, if you do want to use one of the new disk units as your new load source on the logical partition, follow these steps from the dedicated service tools (DST) menu:

1. At the DST menu, select option 11 (Work with system partitions).
2. Select option 4 (Recover configuration data).
3. Select option 5 (Accept load source disk unit).
4. Confirm that you really do want to use the disk as a load source in the logical partition by pressing the F10 key. The server replaces the configuration data on the load source disk unit with the current configuration data.
5. The logical partition may now continue its IPL with the new load source disk unit.

Related tasks

“View the Product Activity Log (PAL) for logical partitions” on page 109

Use Dedicated Service Tools (DST) or System Service Tools (SST) to find system reference codes for logical partitions.

“Clear partition configuration data from nonconfigured disk units” on page 131

When you move disk units among logical partitions or servers, you may need to erase any old configuration data before the server can use the logical partition again.

Copy partition configuration data between IPL sources:

Your server may experience a disk read error of logical partition configuration data if you restart from the A or B IPL source, but not both

The following system reference codes are displayed:

- 1 B193 4511
- 2 xxxx xxx5D (where x equals any value 0-9 or A-F)
- 3 690A 2060

You can copy the data from the functioning source to the faulty source with this procedure.

Note: You should only attempt this when you are certain that the logical partition restarts normally when using the other IPL source.

Perform this procedure from a Dedicated Service Tools (DST) display:

1. If you are doing this on the primary partition, power off all secondary partitions. Otherwise, continue to the next step.
2. Restart your server in manual mode with the other IPL source (for instance, source A if source B fails).
3. From DST, select option 11 (Work with system partitions).

4. Ensure that the configuration information contained on this IPL source is correct. Verify this by following the steps in Managing logical partitions for displaying the logical partition's status. A correct configuration would show your most recent configuration of logical partitions. If it is correct, continue to the next step. If the configuration is not correct, **do not** continue. Consult a service representative.
5. Press the F3 key to return to the Work with System Partitions menu.
6. Select option 4 (Recover configuration data).
7. Select option 6 (Copy configuration data to other side).
8. Confirm your choice by pressing the F10 key.
9. Restart the logical partition using the other IPL source (source B, if source A had the correct configuration data you just copied from).
10. If you continue to have problems, contact a service representative.

Related concepts

“System reference codes (SRCs) for logical partitions” on page 107

Understand how to determine whether your server has run into any logical partitioning errors.

Delete all of your logical partitions:

There may be a time when you need to erase all your logical partitions to make the server non-partitioned again.

It is possible to return all hardware resources to the primary partition. However, **all** user data contained within the secondary partitions will be lost. Make sure that you have adequate backups prepared for all logical partitions.

You can use iSeries Navigator to delete logical partition configuration data. To delete all logical partition configuration data using My Connections, follow these steps:

1. In iSeries Navigator, expand **My Connections** or your active environment.
2. Select the primary partition of the system.
3. Expand **Configuration and Service** and select **Logical Partitions**.
4. Right-click the **Logical Partition** and select **Configure Partitions**. You are now working in the Configure Logical Partitions window.
5. Right-click **Physical System** and select **Recovery** and **Delete all logical partition configuration data**.
6. A confirmation box appears to verify your choice to delete the partition configuration data. Click **OK** to confirm your decision.

To delete all logical partition configuration data using the service tools window, follow these steps:

1. In iSeries Navigator, select **My Connections** or your active environment.
2. Select **Open iSeries Navigator service tools window** in the Taskpad window. If the Taskpad window is not displayed, select **View** and select **Taskpad**.
3. Enter the **IP address** of the service tool network interface to which you want to connect. Click **OK**.
4. You will be prompted for your **Service Tools User ID and password**.
5. Expand the system name select **Logical Partitions**.
6. Right-click the logical partition and select **Configure Partitions**. You are now working in the Configure Logical Partitions window.
7. Right-click **Physical System** and select **Recovery** and **Delete all logical partition configuration data**.
8. A confirmation box appears to verify your choice to delete the partition configuration data. Click **OK** to confirm your decision.

To delete all logical partition configuration data using Management Central, follow these steps:

1. In iSeries Navigator, expand **Management Central**.
2. Expand **Systems with Partitions**.
3. Select the physical system that has the logical partition with which you want to work.
4. Right-click the logical partition and select **Configure Partitions**. You are now working in the Configure Logical Partitions window.
5. Right-click the logical partition and select **Configure Partitions**. You are now working in the Configure Logical Partitions window.
6. Right-click **Physical System** and select **Recovery** and **Delete all logical partition configuration data**.
7. A confirmation box appears to verify your choice to delete the partition configuration data. Click **OK** to confirm your decision.

Related concepts

“Clear partition configuration data for logical partitions” on page 130

You can clear the configuration data for the topics.

Backup and Recovery

Situations requiring the assistance of a service representative

Report server problems that require technical assistance from the Technical Support Center.

Some troubleshooting tasks on the server require the assistance of a customer support representative. These tasks are not common and are only performed if the support representative deems it necessary.

To prevent loss of data and damage to hardware and to find a proper solution, contact your support representative before attempting any of the following tasks.

If you have to perform any of these tasks on your server, immediately contact the iSeries and AS/400 Technical Support Center  for further assistance.

Perform main storage dumps on servers with logical partitions:

When the server has a failure, it may create a main storage dump. A main storage dump copies the contents of the server’s memory to disk. It is an important tool for problem analysis. On a server with logical partitions, there are two types of failures that may cause main storage dumps: server failure and secondary partition failure.

When your server performs a main storage dump, **contact your customer support representative**.

Failures in the primary partition caused by server processing hardware or main storage hardware will cause the entire server to fail. Software failures in a secondary partition will cause only that logical partition to fail.

A server failure may cause a server main storage dump. A secondary partition failure may cause a main storage dump only on that logical partition.

Related concepts

“Forcing a main storage dump on servers with logical partitions”

When the server has a failure, it may create a main storage dump. A main storage dump copies the contents of the server’s main storage to disk. It can be an important tool for problem analysis. When your server performs a main storage dump, **contact your customer support representative**.

Perform a main storage dump

Forcing a main storage dump on servers with logical partitions:

When the server has a failure, it may create a main storage dump. A main storage dump copies the contents of the server's main storage to disk. It can be an important tool for problem analysis. When your server performs a main storage dump, **contact your customer support representative**.

On a server with logical partitions, there are two kinds of main storage dumps you can perform:

- A main storage dump of the server.
- A main storage dump of a secondary partition.

Failures in the primary partition caused by server processing hardware or main storage hardware will cause the entire server to fail. Software failures in a secondary partition will cause only that logical partition to fail.

A server failure may cause a server main storage dump. A secondary partition failure may cause a main storage dump only on that logical partition.

When you are directed to by customer support or your service representative, you can force a main storage dump on a server with logical partitions.

Main storage dump of the server

You should only perform a server main storage dump when directed by a service representative.

Attention: When you perform a server main storage dump, every active secondary partition will also perform a main storage dump. They will all then restart. This could take a long time.

A Work with Partition Status display will appear on the secondary partition's console unless a main storage dump was already in progress. In that case, a Main Storage Dump display will appear on the secondary partition console.

Main storage dump of a secondary partition

You should only perform a secondary partition main storage dump under the direction of a service representative. To perform a main storage dump on a secondary partition, you should be working with the remote control panel. **Function 22** forces a main storage dump on the remote control panel.

In the event you cannot perform function 22 (Force main storage dump) on a secondary partition, perform a system main storage dump under the direction of your service representative. When the Main Storage Dump Occurred display appears on the primary partition's console, press Enter, and select option 6 (Dump all partitions). A main storage dump is initiated for each active partition and needs to be copied to disk for each partition.

Related concepts

"Perform main storage dumps on servers with logical partitions" on page 135

When the server has a failure, it may create a main storage dump. A main storage dump copies the contents of the server's memory to disk. It is an important tool for problem analysis. On a server with logical partitions, there are two types of failures that may cause main storage dumps: server failure and secondary partition failure.

Perform a main storage dump

Related tasks

Access control panel functions

Related information

Perform a manual main storage dump

Using remote service with logical partitions:

Remote service is a way for a service representative to access your server through a modem.

Only use this procedure when directed by your service representative

The logical partition that is using remote service must have an electronic customer support communications IOP with a modem. The IOP needs to be tagged as the ECS resource for the partition.

If the communications IOP is on a shared bus and is used by another partition, switch the IOP to the partition that needs to use the modem. If this IOP also attaches to Operations Console, the console may be unavailable until the IOP is switched back to the original partition.

Attention: It is a security risk to leave remote service enabled when not in use. This would allow someone to access your iSeries server without your knowledge. Ensure it has been deactivated when your service representative has finished using remote service.

To use remote service with logical partitions, you should be working with the remote control panel. **Function 66** activates the remote service and **function 65** deactivates the service. Failure to deactivate the service could create a security risk.

Related tasks

Access control panel functions

Powering on and off a domain with logical partitions:

You can power off and power on a domain when a disk unit input/output processor (IOP) fails.

Only use this procedure when directed by your service representative

When a disk unit IOP fails, the disk units in the IOP could become unusable, or the server could hang. The domain is a group of hardware resources that the system defines as being related.

When you are under the direction of your service representative, perform a power off domain, the server shuts down the failed disk unit IOP. You can replace any failed disk units without restarting the logical partition or entire server.

To power off and power on a domain, you should be working with the remote control panel. Under the directions of your service representative, select **function 68** to power off the domain and **function 69** to power on the domain.

Related tasks

Access control panel functions

Resetting a disk unit IOP with logical partitions:

Use this function to initiate an I/O processor (IOP) dump and an IOP reset or an IOP reload.

Only use this procedure when directed by your service representative

This function becomes enabled when certain disk unit SRCs appear and the associated IOP supports a reset or reload function.

Attention: Incorrect use of this function can cause loss of data. It can also cause failures that may be incorrectly diagnosed as expensive hardware failures.

To reset a disk unit IOP, you should be working with the remote control panel. **Function 67** resets/reloads the disk unit IOP.

Related tasks

Partitioning with an eServer i5

Use this information if you plan to partition with an eServer as the console for managing your i5/OS logical partition.

You can install AIX[®], Linux, and i5/OS on eServer 5xx iSeries models. An iSeries server running these operating systems embraces new applications with increased reliability.

If you plan on partitioning an eServer i5 model refer to the logical partitioning information in the IBM Systems Hardware Information Center.

Related information for logical partitions

The related information lists web sites and IBM Redbooks that are related to logical partitions.

IBM Redbooks

You can also view or print any of the following PDFs:

- Slicing the AS/400 with Logical Partitioning: A How to Guide



(about 2.7 MB)

- LPAR Configuration and Management Working with iSeries Logical Partitions



(about 7.2 MB)

- Linux on the IBM iSeries Server: An Implementation Guide



(about 4.6 MB)

Web sites

- Logical Partitions
- Linux on iSeries

Other information

- Linux in a guest partition
- Backup and recovery
- Capacity on Demand
- Install the i5/OS release and related software

Saving PDF files

To save a PDF on your workstation for viewing or printing:

1. Right-click the PDF in your browser (right-click the link above).
2. Click the option that saves the PDF locally.
3. Navigate to the directory in which you want to save the PDF.
4. Click **Save**.

Downloading Adobe Reader

- | You need Adobe Reader installed on your system to view or print these PDFs. You can download a free copy from the Adobe Web site (www.adobe.com/products/acrobat/readstep.html) .

Code license and disclaimer information

IBM grants you a nonexclusive copyright license to use all programming code examples from which you can generate similar function tailored to your own specific needs.

- | SUBJECT TO ANY STATUTORY WARRANTIES WHICH CANNOT BE EXCLUDED, IBM, ITS PROGRAM DEVELOPERS AND SUPPLIERS MAKE NO WARRANTIES OR CONDITIONS EITHER EXPRESS OR IMPLIED, INCLUDING BUT NOT LIMITED TO, THE IMPLIED WARRANTIES OR CONDITIONS OF MERCHANTABILITY, FITNESS FOR A PARTICULAR PURPOSE, AND NON-INFRINGEMENT, REGARDING THE PROGRAM OR TECHNICAL SUPPORT, IF ANY.

- | UNDER NO CIRCUMSTANCES IS IBM, ITS PROGRAM DEVELOPERS OR SUPPLIERS LIABLE FOR ANY OF THE FOLLOWING, EVEN IF INFORMED OF THEIR POSSIBILITY:

- | 1. LOSS OF, OR DAMAGE TO, DATA;
- | 2. DIRECT, SPECIAL, INCIDENTAL, OR INDIRECT DAMAGES, OR FOR ANY ECONOMIC CONSEQUENTIAL DAMAGES; OR
- | 3. LOST PROFITS, BUSINESS, REVENUE, GOODWILL, OR ANTICIPATED SAVINGS.

- | SOME JURISDICTIONS DO NOT ALLOW THE EXCLUSION OR LIMITATION OF DIRECT, INCIDENTAL, OR CONSEQUENTIAL DAMAGES, SO SOME OR ALL OF THE ABOVE LIMITATIONS OR EXCLUSIONS MAY NOT APPLY TO YOU.

Appendix. Notices

This information was developed for products and services offered in the U.S.A.

IBM may not offer the products, services, or features discussed in this document in other countries. Consult your local IBM representative for information on the products and services currently available in your area. Any reference to an IBM product, program, or service is not intended to state or imply that only that IBM product, program, or service may be used. Any functionally equivalent product, program, or service that does not infringe any IBM intellectual property right may be used instead. However, it is the user's responsibility to evaluate and verify the operation of any non-IBM product, program, or service.

IBM may have patents or pending patent applications covering subject matter described in this document. The furnishing of this document does not grant you any license to these patents. You can send license inquiries, in writing, to:

IBM Director of Licensing
IBM Corporation
North Castle Drive
Armonk, NY 10504-1785
U.S.A.

For license inquiries regarding double-byte (DBCS) information, contact the IBM Intellectual Property Department in your country or send inquiries, in writing, to:

IBM World Trade Asia Corporation
Licensing
2-31 Roppongi 3-chome, Minato-ku
Tokyo 106-0032, Japan

The following paragraph does not apply to the United Kingdom or any other country where such provisions are inconsistent with local law: INTERNATIONAL BUSINESS MACHINES CORPORATION PROVIDES THIS PUBLICATION "AS IS" WITHOUT WARRANTY OF ANY KIND, EITHER EXPRESS OR IMPLIED, INCLUDING, BUT NOT LIMITED TO, THE IMPLIED WARRANTIES OF NON-INFRINGEMENT, MERCHANTABILITY OR FITNESS FOR A PARTICULAR PURPOSE. Some states do not allow disclaimer of express or implied warranties in certain transactions, therefore, this statement may not apply to you.

This information could include technical inaccuracies or typographical errors. Changes are periodically made to the information herein; these changes will be incorporated in new editions of the publication. IBM may make improvements and/or changes in the product(s) and/or the program(s) described in this publication at any time without notice.

Any references in this information to non-IBM Web sites are provided for convenience only and do not in any manner serve as an endorsement of those Web sites. The materials at those Web sites are not part of the materials for this IBM product and use of those Web sites is at your own risk.

IBM may use or distribute any of the information you supply in any way it believes appropriate without incurring any obligation to you.

Licensees of this program who wish to have information about it for the purpose of enabling: (i) the exchange of information between independently created programs and other programs (including this one) and (ii) the mutual use of the information which has been exchanged, should contact:

IBM Corporation

Software Interoperability Coordinator, Department YBWA
3605 Highway 52 N
Rochester, MN 55901
U.S.A.

Such information may be available, subject to appropriate terms and conditions, including in some cases, payment of a fee.

- | The licensed program described in this information and all licensed material available for it are provided
- | by IBM under terms of the IBM Customer Agreement, IBM International Program License Agreement,
- | IBM License Agreement for Machine Code, or any equivalent agreement between us.

Any performance data contained herein was determined in a controlled environment. Therefore, the results obtained in other operating environments may vary significantly. Some measurements may have been made on development-level systems and there is no guarantee that these measurements will be the same on generally available systems. Furthermore, some measurements may have been estimated through extrapolation. Actual results may vary. Users of this document should verify the applicable data for their specific environment.

Information concerning non-IBM products was obtained from the suppliers of those products, their published announcements or other publicly available sources. IBM has not tested those products and cannot confirm the accuracy of performance, compatibility or any other claims related to non-IBM products. Questions on the capabilities of non-IBM products should be addressed to the suppliers of those products.

All statements regarding IBM's future direction or intent are subject to change or withdrawal without notice, and represent goals and objectives only.

All IBM prices shown are IBM's suggested retail prices, are current and are subject to change without notice. Dealer prices may vary.

This information is for planning purposes only. The information herein is subject to change before the products described become available.

This information contains examples of data and reports used in daily business operations. To illustrate them as completely as possible, the examples include the names of individuals, companies, brands, and products. All of these names are fictitious and any similarity to the names and addresses used by an actual business enterprise is entirely coincidental.

COPYRIGHT LICENSE:

This information contains sample application programs in source language, which illustrate programming techniques on various operating platforms. You may copy, modify, and distribute these sample programs in any form without payment to IBM, for the purposes of developing, using, marketing or distributing application programs conforming to the application programming interface for the operating platform for which the sample programs are written. These examples have not been thoroughly tested under all conditions. IBM, therefore, cannot guarantee or imply reliability, serviceability, or function of these programs.

Each copy or any portion of these sample programs or any derivative work, must include a copyright notice as follows:

© (your company name) (year). Portions of this code are derived from IBM Corp. Sample Programs. © Copyright IBM Corp. _enter the year or years_. All rights reserved.

If you are viewing this information softcopy, the photographs and color illustrations may not appear.

Programming Interface Information

This Logical partitions publication documents intended Programming Interfaces that allow the customer to write programs to obtain the services of IBM i5/OS.

Trademarks

The following terms are trademarks of International Business Machines Corporation in the United States, other countries, or both:

- | AIX
- | AS/400
- | AS/400e
- | DB2
- | eServer
- | i5/OS
- | IBM
- | iSeries
- | Lotus
- | OS/400
- | Redbooks

- | Intel, Intel Inside (logos), MMX, and Pentium are trademarks of Intel Corporation in the United States, other countries, or both.

Microsoft, Windows, Windows NT, and the Windows logo are trademarks of Microsoft Corporation in the United States, other countries, or both.

Java and all Java-based trademarks are trademarks of Sun Microsystems, Inc. in the United States, other countries, or both.

- | Linux is a trademark of Linus Torvalds in the United States, other countries, or both.

UNIX is a registered trademark of The Open Group in the United States and other countries.

Other company, product, and service names may be trademarks or service marks of others.

Terms and conditions

Permissions for the use of these publications is granted subject to the following terms and conditions.

Personal Use: You may reproduce these publications for your personal, noncommercial use provided that all proprietary notices are preserved. You may not distribute, display or make derivative works of these publications, or any portion thereof, without the express consent of IBM.

Commercial Use: You may reproduce, distribute and display these publications solely within your enterprise provided that all proprietary notices are preserved. You may not make derivative works of these publications, or reproduce, distribute or display these publications or any portion thereof outside your enterprise, without the express consent of IBM.

Except as expressly granted in this permission, no other permissions, licenses or rights are granted, either express or implied, to the publications or any information, data, software or other intellectual property contained therein.

IBM reserves the right to withdraw the permissions granted herein whenever, in its discretion, the use of the publications is detrimental to its interest or, as determined by IBM, the above instructions are not being properly followed.

You may not download, export or re-export this information except in full compliance with all applicable laws and regulations, including all United States export laws and regulations.

IBM MAKES NO GUARANTEE ABOUT THE CONTENT OF THESE PUBLICATIONS. THE PUBLICATIONS ARE PROVIDED "AS-IS" AND WITHOUT WARRANTY OF ANY KIND, EITHER EXPRESSED OR IMPLIED, INCLUDING BUT NOT LIMITED TO IMPLIED WARRANTIES OF MERCHANTABILITY, NON-INFRINGEMENT, AND FITNESS FOR A PARTICULAR PURPOSE.



Printed in USA